

EPSON

Color Ink Jet Printer

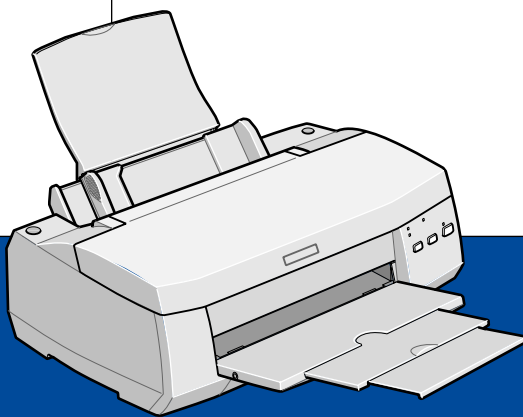

EPSON STYLUS™ COLOR 980

Daily Use

4012511-00
XXX

Where to Find Information

The following guides are included with your printer.

Setup Guide

This guide will help you to install the printer software and set up your printer so that you can start printing.

Daily Use guide

This guide provides information about normal printer operations. It also contains troubleshooting tips and customer support information.

Online guides included on CD-ROM

The guides contained on the CD-ROM included with your printer help you to learn more about your printer and color printing. To view these guides, you must have a Web browser installed on your computer. The included guides are as follows:

- ❑ **Reference Guide** Provides detailed information about printer software settings, printing on special paper, maintenance, and problem solving.
- ❑ **Color Guide** Includes sample images, explanations and troubleshooting information that will answer your questions about color imaging and printing.

Opening the Reference Guide or Color Guide:

Insert the printer software CD in the CD-ROM drive.

For Windows, select Online Guide in the Installer dialog box and click . Then, click View Reference Guide or View Color Guide to open the guide.

For Macintosh, double-click the Online Guide icon in the EPSON window and then the EPSON STYLUS COLOR 980 icon. Then, click View Reference Guide or View Color Guide to open the guide.

Note:

It is possible to install the Reference Guide on your hard disk. See "Installing in Windows" or "Installing in Macintosh" in your Setup Guide for instructions.

All rights reserved. No part of this publication may be reproduced, stored in a retrieval system, or transmitted in any form or by any means, electronic, mechanical, photocopying, recording, or otherwise, without the prior written permission of SEIKO EPSON CORPORATION. The information contained herein is designed only for use with this EPSON printer. EPSON is not responsible for any use of this information as applied to other printers.

Neither SEIKO EPSON CORPORATION nor its affiliates shall be liable to the purchaser of this product or third parties for damages, losses, costs, or expenses incurred by the purchaser or third parties as a result of: accident, misuse, or abuse of this product or unauthorized modifications, repairs, or alterations to this product, or (excluding the U.S.) failure to strictly comply with SEIKO EPSON CORPORATION's operating and maintenance instructions.

SEIKO EPSON CORPORATION shall not be liable for any damages or problems arising from the use of any options or any consumable products other than those designated as Original EPSON Products or EPSON Approved Products by SEIKO EPSON CORPORATION.

SEIKO EPSON CORPORATION shall not be held liable for any damage resulting from electromagnetic interference that occurs from the use of any interface cables other than those designated as EPSON Approved Products by SEIKO EPSON CORPORATION.

EPSON is a registered trademark and EPSON Stylus is a trademark of SEIKO EPSON CORPORATION.

Microsoft and Windows are registered trademarks of Microsoft Corporation.

General Notice: Other product names used herein are for identification purposes only and may be trademarks of their respective owners. EPSON disclaims any and all rights in those marks.

Copyright © 2000 by SEIKO EPSON CORPORATION, Nagano, Japan.



Printed on Recycled Paper.

Contents

Safety Instructions	1
Important Safety Instructions	1
A Few Precautions	2
ENERGY STAR Compliance	4
For United Kingdom Users	5
Warnings, Cautions, and Notes	6
Printer Parts and Functions	7
Printer Parts and Control Panel Functions	7
Loading Special Paper, Envelopes, and Other Media	9
Loading Special Paper and Other Media	9
Loading Envelopes	11
Printing with Windows	13
Printer Software Introduction	13
Making Changes to Printer Settings	15
Previewing your printout	17
Getting Information Through Online Help	20
Printing with Macintosh	21
Printer Software Introduction	21
Making Changes to Printer Settings	21
Previewing your printout	24
Double-Sided Printing	26
Using Double-Sided Printing	26
Replacing Ink Cartridges	30
Replacing an Empty Ink Cartridge	30

Maintenance 32
Checking the Print Head Nozzles 32
Cleaning the Print Head 34
Aligning the Print Head 36

Troubleshooting 38
Correcting USB Problems 38
Using the Error Indicators 42
Typical Problems and Solutions 43
Cancelling Printing 46
Where to Get Help 48

Options and Consumable Products 54
Options and Consumable Products 54

Printer Specifications 59
System Requirements 59

Printing with DOS 62
Installing the Printer Driver for DOS Programs 62
Changing the Print Settings 63
Changing the default settings 64

Safety Instructions

Important Safety Instructions

Read all of the instructions in this section before using your printer. Also, be sure to follow all warnings and instructions that are marked on the printer.

- Do not block or cover the openings in the printer's cabinet. Do not insert objects through the slots.
- Do not spill liquid on the printer.
- Use only the type of power source that is indicated on the printer's label.
- Connect all equipment to properly grounded power outlets. Avoid using outlets that are on the same circuit as photocopiers or air control systems that regularly switch on and off.
- Avoid electrical outlets that are controlled by wall switches or automatic timers.
- Keep the entire computer system away from potential sources of electromagnetic interference, such as loudspeakers or the base units of cordless telephones.
- Do not use a damaged or frayed power cord.
- If you use an extension cord with the printer, make sure that the total ampere rating of the devices that are plugged into the extension cord does not exceed the cord's ampere rating. Also, make sure that the total ampere rating of all devices that are plugged into the wall outlet does not exceed the wall outlet's ampere rating.
- Do not attempt to service the printer yourself.

- ❑ Unplug the printer and refer servicing to qualified service personnel under the following conditions:

The power cord or plug is damaged; liquid has entered the printer; the printer has been dropped or the cabinet damaged; the printer does not operate normally or exhibits a distinct change in performance.

- ❑ If you plan to use the printer in Germany, the building installation must be protected by a 10 or 16 amp circuit breaker to provide adequate short-circuit protection and over-current protection for this printer.

Note for German-speaking users:



Bei Anschluss des Druckers an die Stromversorgung muss sichergestellt werden, dass die Gebäudeinstallation mit einer 10 A- oder 16 A-Sicherung abgesichert ist.

A Few Precautions

Read the information in this section before using the printer, handling the ink cartridges, or choosing a location for the printer.

Using the printer

Observe the following when using the printer.

- ❑ Do not put your hand inside the printer or touch the ink cartridges during printing.
- ❑ Do not move the print head by hand; otherwise, you may damage the printer.
- ❑ Always turn the printer off using the  power button. When this button is pressed, the  power light flashes briefly and then goes off. Do not unplug the printer or turn off the power to the outlet until the  power light stops flashing.
- ❑ Before transporting the printer, make sure that the print head is in the home (far right) position and that the ink cartridges are in place.

Handling the ink cartridges

Observe the following when handling the ink cartridges.

- ❑ Keep ink cartridges out of the reach of children. Do not allow children to drink from or otherwise handle the cartridges.
- ❑ Be careful when you handle the used ink cartridges, as there may be some ink around the ink supply port. If ink gets on your skin, wash the area thoroughly with soap and water. If ink gets in your eyes, flush them immediately with water. If discomfort or vision problems remain after a thorough flushing, see a doctor immediately.
- ❑ Do not shake an ink cartridge; this can cause leakage.
- ❑ Install an ink cartridge immediately after you remove it from its package. Leaving the cartridge unpacked for a long time before use may result in reduced print quality.
- ❑ Once you install an ink cartridge, do not open the clamp or remove the cartridge except to replace it with a new one. Otherwise, the cartridge may become unusable.
- ❑ Do not use an ink cartridge beyond the date printed on the cartridge carton: otherwise, it may result in reduced print quality. For best results, use up the ink cartridges within six months of first installing them.
- ❑ After bringing an ink cartridge inside from a cold storage site, allow it to warm up at room temperature for at least three hours before using it.
- ❑ Store ink cartridges in a cool, dark place.
- ❑ Do not dismantle the ink cartridges or try to refill them. This could damage the print head.

Choosing a place for the printer

Observe the following when choosing a place for the printer.

- ❑ Place the printer on a flat, stable surface that extends beyond the printer base in all directions. The printer will not operate properly if it is tilted or at an angle.
- ❑ Avoid places that are subject to rapid changes in temperature and humidity. Also, keep the printer away from direct sunlight, strong light, and heat sources.
- ❑ Avoid places that are subject to shocks and vibrations.
- ❑ Leave enough room around the printer to allow for sufficient ventilation.
- ❑ Avoid places subject to dust.
- ❑ Place the printer near a wall outlet where the plug can be easily unplugged.

Note for French-speaking users:

Placez l'imprimante près d'une prise de contact où la fiche peut être débranchée facilement.

ENERGY STAR Compliance



As an ENERGY STAR Partner, EPSON has determined that this product meets the ENERGY STAR guidelines for energy efficiency.

The International ENERGY STAR Office Equipment Program is a voluntary partnership with the computer and office equipment industry to promote the introduction of energy-efficient personal computers, monitors, printers, fax machines, copiers, and scanners, in an effort to reduce air pollution caused by power generation.

For United Kingdom Users

Use of options

EPSON (UK) Limited shall not be liable against any damages or problems arising from the use of any options or consumable products other than those designated as Original EPSON Products or EPSON Approved Products by EPSON (UK) Limited.

Safety information



Warning:

This appliance must be earthed. Refer to the rating plate for voltage and check that the appliance voltage corresponds to the supply voltage.

Important:

The wires in the mains lead fitted to this appliance are coloured in accordance with the following code:

Green and yellow — Earth

Blue — Neutral

Brown — Live

If you have to fit a plug:

As the colours of the mains lead for this appliance may not match the coloured markings used to identify the terminals in a plug, please proceed as follows:

The green and yellow wire must be connected to the terminal in the plug that is marked with the letter E or the earth symbol (\perp).

The blue wire must be connected to the terminal in the plug that is marked with the letter N.

The brown wire must be connected to the terminal in the plug that is marked with the letter L.

If damage occurs to the plug, replace the cord set or consult a qualified electrician.

Replace fuses only with a fuse of the correct size and rating.

Warnings, Cautions, and Notes



Warnings

must be followed carefully to avoid bodily injury.









Cautions

must be observed to avoid damage to your equipment.





Notes

contain important information and useful tips on the operation of your printer.

Buttons

Button	Function
 power	Turns the printer on and off. Clears the printer's memory if pressed twice while the power is on.
 load/eject	Loads or ejects paper if pressed and released within 2 seconds. Resumes printing if pressed and released after a paper out error.
 cleaning	Moves the print head to the ink cartridge replacement position if pressed for 3 seconds while the  black or  color ink out light is flashing or on. Returns the print head to its home position after ink cartridge replacement. Performs print head cleaning if pressed for 3 seconds when the  black or  color ink out light is off.

Lights

Light	Description
 power	On when the printer is on. Flashing when printer is receiving data, printing, replacing an ink cartridge, charging ink, or cleaning the print head.
 paper out	On when the printer is out of paper. Load paper in the sheet feeder, then press the  load/eject button to resume printing. Flashing when the paper is jammed. Take all of the paper out of the feeder, then reload the paper. If the light continues to flash, turn off the printer and gently pull all of the paper out of the printer.
 black ink out	On when the black ink cartridge is empty. Replace the black ink cartridge (T003). Flashing when the black ink cartridge is nearly empty.
 color ink out	On when the color ink cartridge is empty. Replace the color ink cartridge (T005). Flashing when the color ink cartridge is nearly empty.

Loading Special Paper, Envelopes, and Other Media

Loading Special Paper and Other Media

You can print on a wide variety of special media, including ink jet paper, photo quality glossy film, photo paper, transparencies, index cards, and adhesive sheets.

When loading special media that is distributed by EPSON, read the instruction sheets packed with the media first and keep the points listed below in mind. For more details on using special media, see “Paper Handling” in the online *Reference Guide*.

- ❑ Make sure that the printable side of the paper is facing up when loading media into the sheet feeder. See the instruction sheets packed with the media to determine which side is the printable surface. Some types of media have cut corners to help identify the correct loading direction, as shown in the illustration.

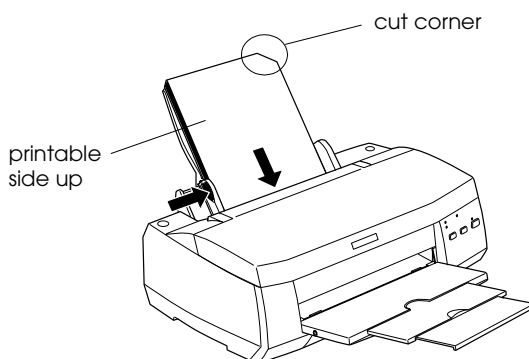

- ❑ Make sure that the paper stack fits under the arrow mark that is located on the inside surface of the left edge guide.

Loading capacities for EPSON special media

See below to find the loading capacities for EPSON special media.

Media Type	Loading Capacity
360 dpi Ink Jet Paper and Photo Quality Ink Jet Paper	Up to the arrow mark on the left edge guide.
Photo Quality Ink Jet Cards, Ink Jet Note Cards, and Ink Jet Greeting Cards	Up to 30 cards. Always place the included support sheet* under the cards.
Photo Quality Glossy Film	One sheet at a time or a maximum of 20 sheets. When loading multiple sheets, set the minimum top margin of the page to 30 mm. Always put a support sheet* or a sheet of plain paper under the glossy film.
Ink Jet Transparencies	Up to 30 transparencies. Always put a sheet of plain paper under the stack of transparencies.
Photo Quality Self Adhesive Sheets	One sheet at a time.
Photo Paper	Up to 20 sheets. For 200 × 300 mm Photo Paper, you can only load one sheet at a time. Always put a support sheet* under the stack of Photo Paper.
Premium Glossy Photo Paper	One sheet at a time.
Photo Stickers 16 and Photo Stickers 4	One sheet at a time.
Panoramic Photo Paper and Iron-On Cool Peel Transfer Paper	One sheet at a time.
Matte Paper-Heavyweight	Up to 20 sheets. Always put a support sheet* under the stack of Matte Paper-Heavyweight.

* Do not print on support sheets that are loaded under special media.

About special media cleaning sheets

Cleaning sheets that are packaged with EPSON special media should not be used with this printer. The cleaning function performed by these sheets is not necessary with this type of printer and the sheets may jam in the printer.

Loading Envelopes

When printing on envelopes, please note the following:

- You can load up to 10 envelopes in the sheet feeder.

Note:

The folding quality and thickness of envelopes varies widely. If the total thickness of the stack of envelopes exceeds 10 mm, press each envelope in the stack flat before loading.

- Set the adjust lever to the “+” position. To do this, open the printer cover and reposition the lever.

Note:

- Return the adjust lever to the “0” position, which is the normal position, after you finish printing on envelopes. Leaving the lever in the “+” position may cause gaps to appear in images that are printed on other media.*
- When the adjust lever is in the “+” position, make sure that the High Speed check box in the printer driver’s Advanced dialog box is cleared. To clear this check box, you may also need to change the Print Quality setting.*

- ❑ Load envelopes flap edge first with the flap side down, as shown in the illustration.

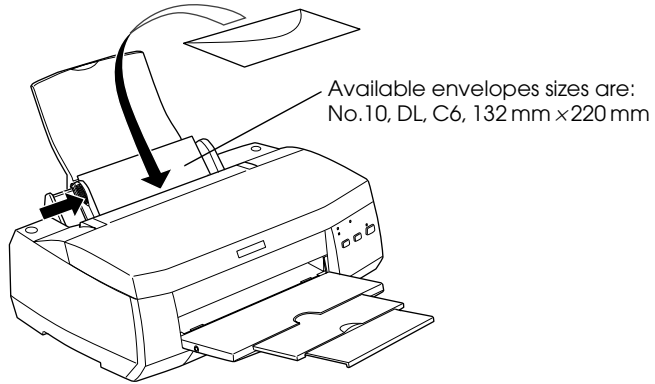

- ❑ Do not use envelopes that are curled or folded. Flatten the envelope flaps before loading. Avoid using envelopes that are too thin as they may curl during printing.
- ❑ Select Plain Paper as the Media Type setting in the printer driver.

Printing with Windows

Printer Software Introduction

The printer software CD-ROM which comes with your printer includes a printer driver and printer utilities. The printer driver lets you choose from a wide variety of settings to achieve the best results with your printer. The printer utilities help you to check the printer and keep it in top condition.

Getting more information

For information on using the printer driver, see “Making Changes to Printer Settings” on page 15.

For information on using the printer utilities, see “Using the Printer Utilities” in the online *Reference Guide*.

Note:

The specific features available in the printer software vary, depending on the version of Windows that you are using.

Online help provides more information about the printer software. See “Getting Information Through Online Help” on page 20 for instructions on accessing help.

Accessing the printer software

You can access the printer software from most Windows applications, from the Windows Start menu (Windows 98, 95, 2000, and NT 4.0), or from the Control Panel (Windows 3.1).

When you access the printer software from a Windows application, the settings that you make apply only to the application that you are using.

When you access the printer software from the Start menu, the settings that you make apply to all of your Windows applications.

Refer to the appropriate section below.

From Windows applications

Follow the steps below to access the printer software from Windows applications.

1. From the File menu, click Print or Print Setup.
2. In the dialog box that appears, click Printer, Setup, Options, or Properties. (Depending on your application, you may need to click a combination of these buttons.) The printer driver opens.

From the Windows Start menu (Windows 98, 95, 2000, and NT 4.0)

Follow the steps below to access the printer software from the Start menu.

1. Click Start, point to Settings, then click Printers.
2. For Windows 98 and 95, select your printer, then click Properties on the File menu. For Windows 2000, select your printer, then click Printing Preferences on the File menu. For Windows NT 4.0, select your printer, then click Document Defaults on the File menu. The printer driver opens.

From the Control Panel (Windows 3.1)

Follow the steps below to access the printer software from the Control Panel in Windows 3.1.

1. Double-click the Control Panel icon in the Main program group.
2. Double-click the Printers icon.

3. Select your printer in the Installed Printers list.
4. Click Setup. The printer driver opens.

Making Changes to Printer Settings

The printer driver features the following menus and settings.

Main: Media Type, Ink, Mode, Print Preview

Paper: Paper Size, Copies, Orientation, Printable Area

Layout: Reduce/Enlarge, Double-Sided Printing, Multi-Page, Watermark

Note:

The Layout menu is available only for Windows 98, 95, 2000, and NT 4.0 users.

The Mode settings on the Main menu are arranged to give you three levels of control over the printer driver, as explained below.

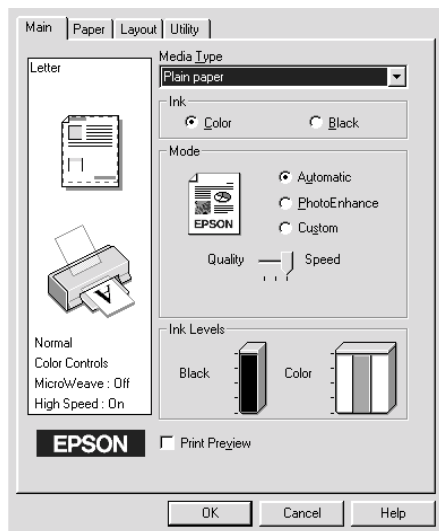

Automatic	When this mode is selected, the printer driver takes care of all detailed settings based on the current Media Type and Ink settings. To make the Ink setting, click Color to print in color, or Black to print in black-and-white or grayscale. Depending on the media selected in the Media Type list (while Automatic is selected), a slider appears under the Custom radio button that lets you choose either Quality or Speed. Select Quality when print quality is more important than speed.
PhotoEnhance	This mode provides a variety of image-correction settings that you can apply to your photos before printing. PhotoEnhance does not affect your original data. This mode is only available when printing 16-, 24-, or 32-bit color data.
Custom	This mode offers ready-made settings designed for printing text and graphs and for applying a color-matching method. You can also create and save your own custom settings using the settings in the Advanced dialog box.

In addition to making comprehensive Mode settings that affect overall print quality, you can also modify individual aspects of your printout using the Paper and Layout menus. For more information about the Paper and Layout menus, see your online *Reference Guide*.

Making the Media Type setting

The Media Type setting determines what other settings are available, so you should always make this setting first.

On the Main menu, select the Media Type setting that matches the media that is loaded in the printer. To determine what Media Type you are using, locate your media in the list found under “Media types” on page 56, and refer to the corresponding Media Type under which it is grouped (shown in larger type). For some types of media, there are several Media Type settings to choose from.

Note:

For Windows 3.1 users, if the Media Type that you wish to select does not appear in the list, make the Print Quality setting in the More Settings dialog box first. To access this dialog box, click the Advanced button on the Main menu, then click More Settings.

Previewing your printout

Select the Print Preview check box on the Main menu to see a preview of your document before printing.

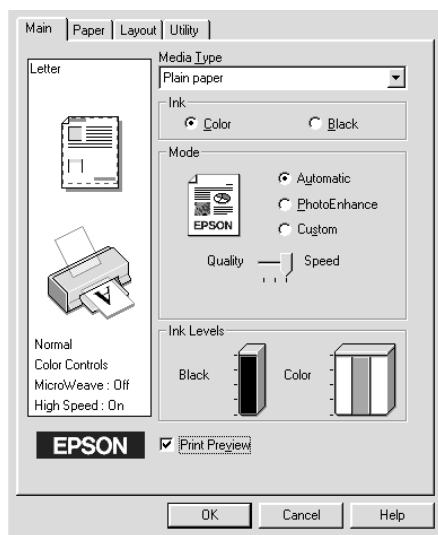

Note:

This feature is not available for Windows 3.1.

When you send a print job to the printer, the Print Preview window opens, allowing you to make changes before printing.

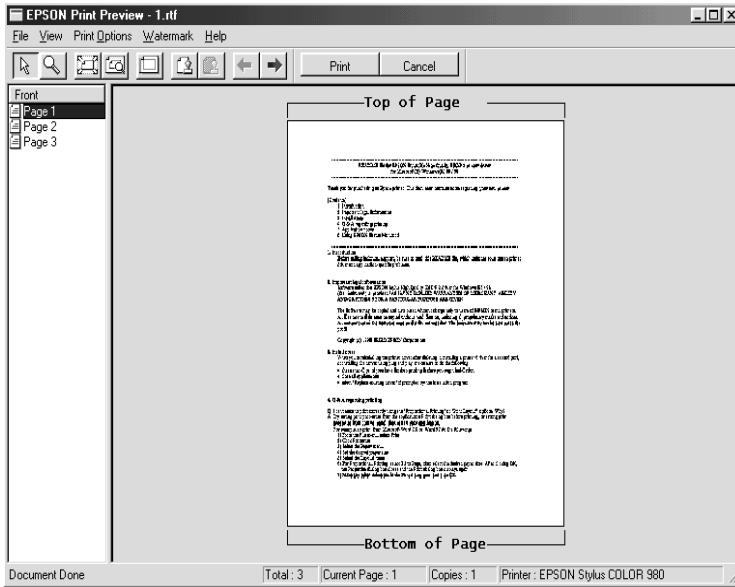

The Preview dialog box contains several icon buttons that allow you to perform various functions. See online help for each function.

You can also manipulate the previewed document in the following ways:

- Select and preview individual pages.
- Reduce or enlarge the size of the preview.
- Select and print any or all pages.
- Magnify the previewed document. To do this, click View and then Magnify to open the Magnify window, which magnifies the area of the previewed document which is outlined by a red box. By dragging the red box, you can change which part of the document is magnified.

- ❑ View the individual pages that comprise a poster. The Poster window opens automatically when you send a print job while Poster is selected as the Multi-Page option on the Layout menu. From this window, you can view the individual pages which make up a poster. You can also open this dialog box by clicking View and then Poster.
- ❑ Apply watermarks. The watermark that you select will appear in the previewed image. For detailed information on customizing watermarks, see “Printing a watermark on your document” in the online *Reference Guide*.
- ❑ Specify which pages in the document you would like printed using the Add and Remove features. To add or remove a page, you must first click the page icon in the list appearing at the left side of the preview window. Then add or remove it using the commands on the Print Options menu.

Note:

- ❑ *When using the double-sided printing feature, the Preview window allows you to toggle between pages in the print job by clicking the appropriate page in the list at the left side of the screen. The pages are listed in two columns, Front and Back. The pages in the Front column will print first. The page numbers listed refer to pages of the print job, and may contain more than one document page.*
- ❑ *If it is necessary to reprint part of a double-sided print job, select each page of the print job that does not need to be reprinted in the list at the left side of the screen, then click Remove Page on the Print Options menu. Make sure that the paper is loaded properly so that the print job will start on the correct side of the correct page.*

After you have previewed the document, click Print to print the document, or click Cancel to cancel printing.

Getting Information Through Online Help

Your printer software has an extensive online help feature, which provides you with instructions on printing, making printer driver settings, and using the printer utilities. In Windows 98, 95, 2000, and NT 4.0, you can access online help from an application or from the Windows Start menu. In Windows 3.1, you can access online help through the EPSON program group. Refer to the appropriate section below.

Accessing help from an application

To access help from an application, open the application's File menu and choose Print or Print Setup. Then click Printer, Setup, Options, or Properties. (Depending on the application, you may need to click a combination of these buttons.) Click Help at the bottom of the Main, Paper, Layout, and Utility menu for help related to that menu.

For Windows 98, 95, 2000, and NT 4.0, you can get specific help related to any item on a menu by right-clicking the item, then clicking the What's This? command in the shortcut menu that appears. The help contents window opens.

Accessing help from the Windows Start menu

To access help from the Start menu, click the Start button, point to Programs and then to Epson (for Windows 98 and 95) or EPSON Printers (for Windows 2000 and NT 4.0), then click EPSON Stylus COLOR 980 Help. The help contents window opens.

Accessing help from Windows 3.1

To access help in Windows 3.1, open the EPSON program group and click the EPSON Stylus COLOR 980 Help icon. The help contents window opens.

Printing with Macintosh

Printer Software Introduction

The printer software that comes with your printer includes a printer driver and printer utilities. The printer driver lets you choose from a wide variety of settings to get the best results from your printer. The printer utilities help you check the printer and keep it in top operating condition.



For information on using the printer driver, see “Making Changes to Printer Settings” on page 21.

For information on using the printer utilities, see “Using the Printer Utilities” in the online *Reference Guide*.

You can also get more information about the printer software by clicking the help icon in any of the dialog boxes in the printer driver.

Making Changes to Printer Settings

You will find the printer driver settings in the following dialog boxes.

- Print dialog box (click Print on the File menu of your application or click Options in the Page Setup dialog box)
- Background Printing dialog box (click the  Background Printing icon button located in the Print dialog box)
- Page Setup dialog box (click Page Setup on the File menu of your application)
- Layout dialog box (click the  Layout icon button in the Print dialog box)
- Preview dialog box (click the  Preview icon button in the Print dialog box and then click Preview)

The Mode settings in the Print dialog box are arranged to give you three levels of control over the printer driver.

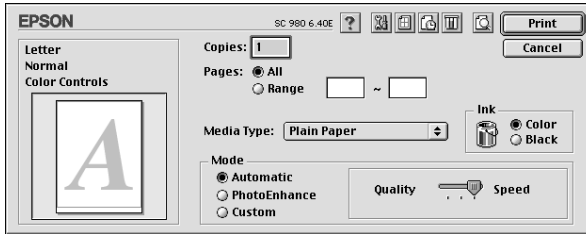

The Mode settings are explained below.

<p>Automatic</p>	<p>When this mode is selected as the Mode setting in the Print dialog box, the printer driver takes care of all detailed settings based on the current Media Type and Ink settings. To make the Ink setting, click Color to print in color, or Black to print in black-and-white or grayscale. Depending on the media that you choose in the Media Type list (while Automatic is selected), a slider appears to the right of the Mode options that lets you choose Quality or Speed. Select Quality when print quality is more important than speed.</p>
<p>PhotoEnhance</p>	<p>This mode provides a variety of image-correction settings that you can apply to your photos before printing. PhotoEnhance does not affect your original data. This mode is only available when printing 32-bit color data.</p>
<p>Custom</p>	<p>The Custom mode offers ready-made settings designed for printing text and graphs and for applying a color-matching method. You can also create and save your own custom settings using the settings in the Advanced dialog box.</p>

In addition to making comprehensive Mode settings that affect overall print quality, you can also modify individual aspects of your printout using the settings contained in the Page Setup and the Layout dialog boxes.



Making the Media Type setting

The Media Type setting determines what other settings are available, so you should always make this setting first.

In the Print dialog box, select the Media Type setting that matches the paper that is loaded in the printer. To find out what Media Type you are using, find your media in the list found under “Media types” on page 56, and refer to the corresponding media type under which it is grouped (shown in larger type). For some types of media, there are several Media Type settings to choose from.

Saving spool data as a file

You can save the spool data as a file by using the Save File feature in the Print dialog box. This feature lets you print the file at a later time using the saved spool data, simply by double-clicking the saved file. Follow the steps below to save spool data for files and to print files using saved spool data.

1. Make your printer driver settings.
2. Click the  Preview icon button in the Print dialog box repeatedly until the Print button changes into the Save File button.
3. Click the Save File button.
4. Browse for the location where you want to save the file, then type a file name in the Save As text box and click **SAVE**. The print settings are now saved for this file.
5. When you want to print the document, double-click the file to open EPSON Monitor 3, make sure that the correct document is selected, then click the  Resume button to send the data to the printer.

Note:

- ❑ *When using the double-sided printing feature, the Preview window allows you to toggle between pages in the print job by clicking the appropriate page in the list at the left side of the screen. The pages are listed in two columns, Front and Back. The pages in the Front column will print first. The page numbers listed refer to pages of the print job, and may contain more than one document page.*
 - ❑ *If it is necessary to reprint part of a double-sided print job, select each page of the print job that does not need to be reprinted in the list at the left side of the screen, then click the  remove page button. Make sure that the paper is loaded properly so that the print job will start on the correct side of the correct page.*
4. If you are satisfied with the previewed image, click Print.

If you are not satisfied with the appearance of the image, click Cancel. The Preview and Print dialog boxes close with the current print settings preserved. Open the Print dialog box again to make additional changes to the print settings.

Double-Sided Printing

Using Double-Sided Printing

The EPSON Stylus COLOR 980 allows double-sided printing. There are two types of double-sided printing available. Standard double-sided printing allows you to print the odd-numbered pages first. Once these are printed, you can reload the printouts in the sheet feeder and print the even-numbered pages on the other side of the paper. Folded Booklet double-sided printing allows you to make single-fold booklets. For more details about making single-fold booklets and double-sided printing, refer to your online *Reference Guide*.

Note:

- ❑ *Double-sided printing via a network is possible when the High-Speed Printing is set to ON in EpsonNet Direct Print Version 2 or higher, running on the server. For details, please refer to the Readme file on the Printer software CD-ROM.*
- ❑ *You can load up to 30 sheets of paper at one time when double-sided printing; however, the loading capacity of the sheet feeder varies, depending on the media type.*
- ❑ *Only use media types which are suitable for double-sided printing. Otherwise, the printout quality may deteriorate.*
- ❑ *This feature is not available for Windows 3.1 users.*
- ❑ *Depending on the type of paper and the amount of ink used to print text and images, ink may bleed through to the other side of the paper.*

For Windows users, select the Double-Sided Printing check box on the Layout menu of your printer driver to use the double-sided printing feature. To access your printer driver, see “Accessing the printer software” on page 13.

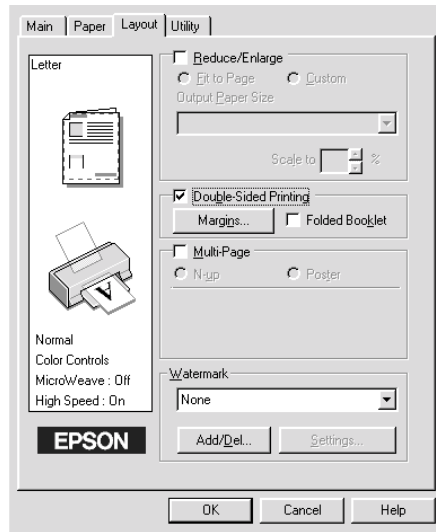

For Macintosh users, select the Double-Sided Printing check box in the Page Setup dialog box. For information on making settings in this dialog box, see “Making Changes to Printer Settings” on page 21.

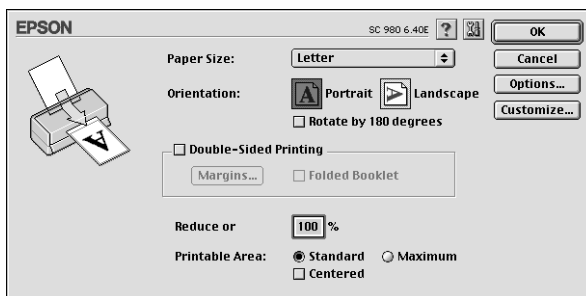

Once the Double-Sided Printing check box is selected, it is possible to make the following double-sided printing settings.

Margins

Click this button to open the Margins dialog box, where you can specify which edge the binding will be on. You can choose between Left, Top, and Right. You can also specify the width of the binding margin by entering a value in the Binding Margin text box.

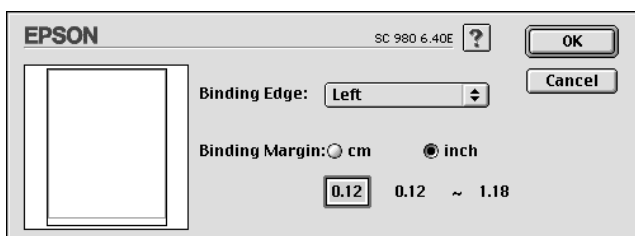
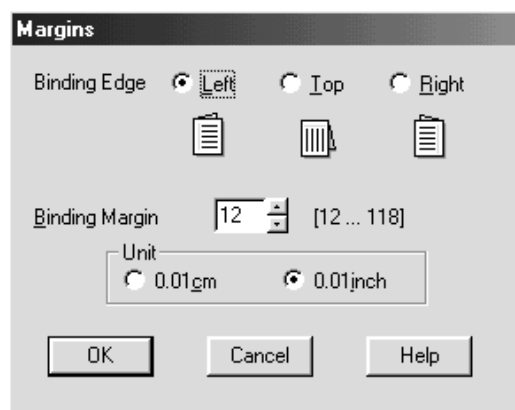

Folded Booklet

Select this check box to make single-fold booklets. For more details on this feature, refer to your online *Reference Guide*.

Once you have made your settings, click OK to save them. Load paper in the sheet feeder, then send the print job from your application. The odd-numbered pages will print first, unless Folded Booklet is selected. While the printer is printing the odd-numbered pages, instructions are displayed which explain how to reload the paper correctly. Follow the instructions to reload the paper, then click Resume to print the even-numbered pages.

Replacing Ink Cartridges



Replacing an Empty Ink Cartridge

Follow the instructions in this section to replace an ink cartridge using the printer's control panel or the Status Monitor utility.









Using the printer's control panel

The printer's indicator lights will inform you when it is time to obtain a replacement ink cartridge and when it is time to replace an empty cartridge. You can also check ink levels and start the ink cartridge replacement procedure from your computer using the Status Monitor utility. See the online *Reference Guide* for more information.

Note:

If you need to replace an ink cartridge while the  black and  color ink out lights are off, see "Replacing an Old or Damaged Ink Cartridge" in the online *Reference Guide*.

The following table describes the status of the lights on your printer and the actions that you need to take.

Light	Action
 	Obtain a replacement black ink cartridge (T003).
 	Replace the empty black ink cartridge.
 	Obtain a replacement color ink cartridge (T005).
 	Replace the empty color ink cartridge.

■ = on, □ = flashing

**Warning:**

- ❑ *Keep ink cartridges out of the reach of children. Do not allow children to drink from or otherwise handle the cartridges.*
- ❑ *If ink gets on your skin, wash it thoroughly with soap and water. If ink gets in your eyes, flush them immediately with water. If discomfort or vision problems remain after a thorough flushing, see a doctor immediately.*

**Caution:**

- ❑ *EPSON recommends the use of genuine EPSON ink cartridges. Other products not manufactured by EPSON may cause damage to your printer not covered by EPSON's warranties.*
- ❑ *Leave the old cartridge installed in the printer until you have obtained a replacement; otherwise, ink remaining in the print head nozzles may dry out.*

Note:

- ❑ *You cannot continue printing with one ink cartridge empty, even if the other cartridge still contains ink. Before printing, replace the empty cartridge.*
- ❑ *In addition to the ink used during printing, ink is consumed during the print head cleaning operation and during the self-cleaning cycle which is performed when the printer is turned on.*

To replace an ink cartridge using the printer's control panel, refer to the online *Reference Guide*.

Note:

You can also replace an ink cartridge from your computer using the Status Monitor. Click the Replace Ink Cartridge button in the Status Monitor's Printer Status window, then follow the on-screen instructions.

Maintenance

Checking the Print Head Nozzles

If you find that the printed image is unexpectedly faint or that dots in the printed image are missing, you may be able to identify the problem by checking the print head nozzles.

You can check the print head nozzles from your computer using the Nozzle Check utility in the printer software, or from the printer using the printer's control panel buttons.

For more information about the control panel buttons, see your online *Reference Guide*.

Using the Nozzle Check utility

To use the Nozzle Check utility, refer to the appropriate section below.

Note:

Do not use the Nozzle Check utility while printing is in progress; otherwise, your printout may be marred.

For Windows users

Follow the steps below to use the Nozzle Check utility.

1. Make sure that A4 or Letter size paper is loaded in the sheet feeder.
2. Click the Utility tab in the printer software, then click the Nozzle Check button.
3. Follow the on-screen instructions.

For Macintosh users

Follow the steps below to use the Nozzle Check utility.

1. Make sure that A4 or Letter size paper is loaded in the sheet feeder.
2. Access the Print or Page Setup dialog box.
3. Click the  Utility icon button, then click the Nozzle Check button.
4. Follow the on-screen instructions.

The printer prints an operation check page that includes your printer's ROM version information, the ink counter code, and a nozzle check pattern. Below are sample printouts.

Good sample



Print head needs to be cleaned

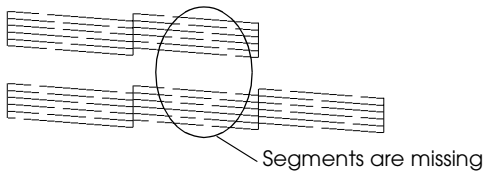

The above sample is in black and white, but the actual test prints in color (CMYK).



If the nozzle check page does not print satisfactorily (for example, if any segment of the printed lines is missing), there is a problem with the printer. This could be a clogged ink nozzle or a misaligned print head. See the next section for details on cleaning the print head. For information on aligning the print head, see "Aligning the Print Head" on page 36.

Cleaning the Print Head

If you find that the printed image is unexpectedly faint or that dots in the printed image are missing, you may be able to solve these problems by cleaning the print head, which ensures that the nozzles are delivering ink properly.

You can clean the print head from your computer using the Head Cleaning utility in the printer software, or from the printer itself by using the printer's control panel buttons. For more information about the control panel buttons, see your online *Reference Guide*.

Note:



- ❑ *Print head cleaning uses both color and black ink. To avoid wasting ink, clean the print head only if print quality declines. For example, if the printout is blurry or the color is incorrect or missing.*
- ❑ *Use the Nozzle Check utility first to confirm that the print head needs to be cleaned. This saves ink.*
- ❑ *You cannot clean the print head while the  black or  color ink out light is flashing or on. Replace the appropriate ink cartridge first.*
- ❑ *Do not start the Head Cleaning or Nozzle Check utility while printing is in progress; otherwise, your printout may be marred.*

Using the Head Cleaning utility



Refer to the appropriate section below to clean the print head using the Head Cleaning utility.

For Windows users

Follow the steps below to clean the print head.

1. Make sure that the printer is on and both the  black and  color ink out lights are off.



Note:

If the  black or  color ink out light is flashing, you cannot clean the print head. Replace the appropriate ink cartridge first.

2. Click the Utility tab in the printer driver, then click the Head Cleaning button.
3. Follow the on-screen instructions.

For Macintosh users

Follow the steps below to clean the print head.

1. Make sure that the printer is on, and the  black and  color ink out lights are off.
2. Click the  Utility icon button in the Print or Page Setup dialog box, then click the Head Cleaning button.
3. Follow the on-screen instructions.

If print quality hasn't improved after repeating this procedure four or five times, turn the printer off and leave it alone overnight. Then, perform the head cleaning again.

If the print quality still has not improved, one or both of your ink cartridges may be old or damaged and may need to be replaced. To replace an ink cartridge before it is empty, see "Replacing Ink Cartridges" in the online *Reference Guide*.

If print quality remains a problem after replacing the ink cartridges, contact your dealer.

Note:

To maintain print quality, EPSON recommends turning on the printer for at least one minute every month.

Aligning the Print Head

If you notice a misalignment of vertical lines, you may be able to solve this problem using the Print Head Alignment utility in your printer software. Follow the directions in the appropriate section below.

Note:

Do not start the Print Head Alignment utility while printing is in progress; otherwise, your printout may be marred.

For Windows users

Follow the steps below to align the print head.

1. Make sure that A4 or Letter size plain paper is loaded in the sheet feeder.
2. Click the Utility tab in the printer driver, then click the Print Head Alignment button.
3. Follow the on-screen instructions to align the print head.

For DOS users

Follow the steps below to align the print head.

1. Insert the printer software CD in your CD-ROM drive.
2. Type D:\SETUP at the DOS prompt. (If your CD-ROM drive is assigned a drive letter other than "D", or if you are using the floppy disk version, substitute the appropriate letter.)
3. Press the Enter key, then follow the on-screen instructions.
4. After running the setup program, type C:\EPCALIB2. (If your hard drive is assigned a drive letter other than "C", substitute the appropriate letter.)

5. Press the Enter key. The following window appears.

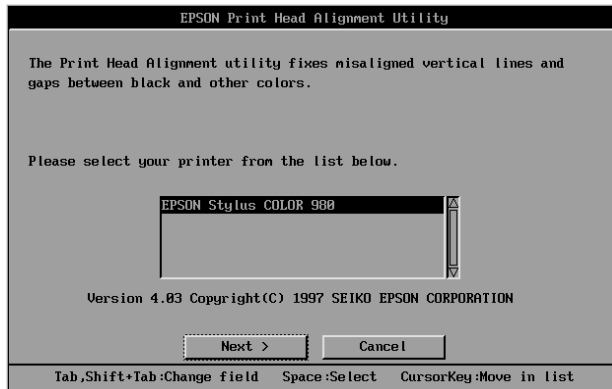

6. Make sure that your printer is selected. Click Next, then follow the on-screen instructions.

For Macintosh users

Follow the steps below to align the print head.

1. Make sure that A4 or Letter size plain paper is loaded in the sheet feeder.
2. Click the  Utility icon button in the Print or Page Setup dialog box, then click the Print Head Alignment button.
3. Follow the on-screen instructions to align the print head.

Troubleshooting

Correcting USB Problems

Make sure that your computer is a Windows 98 or Windows 2000 pre-installed model

Your computer must be a Windows 98 or Windows 2000 pre-installed model. You may not be able to install or run the USB Printer Driver on a computer which is not equipped with a USB port or which has been upgraded from Windows 95 to Windows 98 or 2000.

For details about your computer, contact your dealer.

Make sure that EPSON USB Printer Devices appears in the list on the Device Manager menu (for Windows 98 only)

If you canceled the plug-and-play driver installation before the procedure was completed, either the USB printer device driver or the printer driver may be installed incorrectly.

Follow the steps below to check the installation and reinstall the drivers.

1. Turn the printer on. Plug the USB cable into the printer and the computer.
2. Right-click the My Computer icon on your desktop, then click Properties in the shortcut menu that appears.
3. Click the Device Manager tab.

If your drivers are correctly installed, EPSON USB Printer Devices should appear in the list on the Device Manager menu.

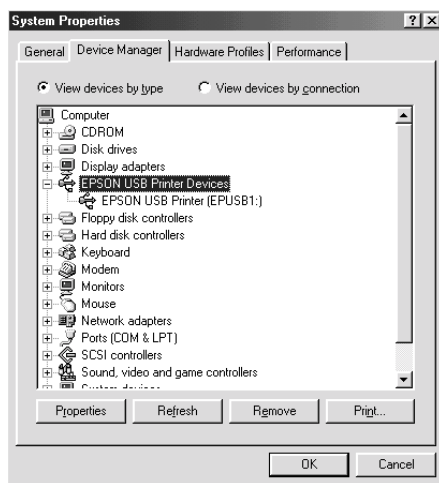

If EPSON USB Printer Devices does not appear in the list, click the plus (+) sign beside Other Devices to view the installed devices.



If USB Printer appears under Other Devices, the USB printer device driver is not installed correctly. If EPSON Stylus COLOR 980 appears, the printer driver is not installed correctly.

If neither USB Printer nor EPSON Stylus COLOR 980 appears under Other Devices, click Refresh or unplug the USB cable from the printer, then plug it into the printer again.

4. Under Other Devices, select USB Printer or EPSON Stylus COLOR 980, then click Remove. Then click OK.

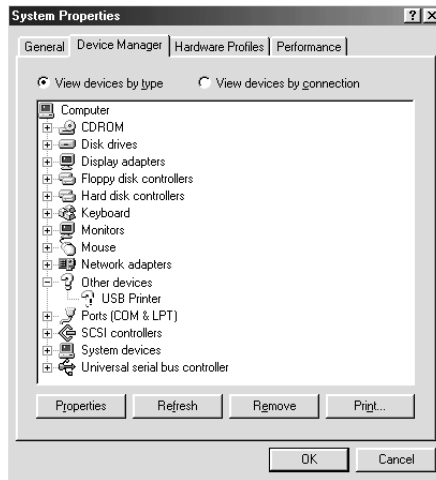

5. When the following dialog box appears, click OK. Then click OK again to close the Properties window.

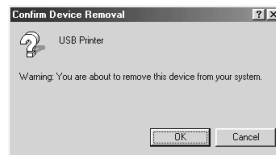

6. Turn off both the printer and the PC. Then, install the drivers again, following the instructions in the *Setup Guide*.









Printer does not work correctly with a USB cable



















If your printer does not work correctly with a USB cable, try one or more of these solutions:

- ❑ Use the recommended USB cable as described in “System Requirements” in the online *Reference Guide*.
- ❑ If you use a USB hub, connect the printer to the first tier of the hub, or connect the printer to the computer’s USB port directly.
- ❑ For Windows 98 users, try reinstalling the USB printer device driver and the printer software. First, uninstall EPSON Printer Software using the Add/Remove Programs utility in the Control Panel, then uninstall EPSON USB Printer Devices. Next, reinstall the software as described in *Setup Guide*. If EPSON USB Printer Devices is not registered in the Add/Remove Programs list, browse the CD-ROM and double-click `epusbun.exe` in the Win 9x folder. Then, follow the on-screen instructions.

Using the Error Indicators

You can identify many common printer problems using the lights on your printer's control panel. If your printer stops working and the lights are on or flashing, use the following table of panel light patterns to diagnose the problem, then follow the recommended corrective measures.

Lights	Problem and solutions	
	Paper out	
	No paper is loaded in the sheet feeder.	Load paper in the sheet feeder, then press the  load/eject button. The printer resumes printing and the light goes out.
	Paper jam	
	Paper has jammed in the printer.	Press the  load/eject button to eject the jammed paper. If the error does not clear, open the printer cover and remove all of the paper inside, including any tone pieces. Then, reload the paper in the sheet feeder and press  load/eject button to resume printing.
	Ink low (black ink cartridge)	
	The black ink cartridge is nearly empty.	Obtain a replacement black ink cartridge (T003).
	Ink out (black ink cartridge)	
	The black ink cartridge is empty.	Replace the black ink cartridge with a new one (T003). See "Replacing Ink Cartridges" on page 30 for details.
	Ink low (color ink cartridge)	
	The color ink cartridge is nearly empty.	Obtain a replacement color ink cartridge (T005).

 	Ink out (color ink cartridge)	
	The color ink cartridge is empty.	Replace the color ink cartridge with a new one (T005). See "Replacing Ink Cartridges" on page 30 for details.
       	Carriage error	
	The print head is obstructed by jammed paper or other foreign material and cannot return to the home position.	Turn off the printer. Open the printer cover and remove any paper from the paper path by hand. Then, does turn the printer back on. If the error does not clear, contact your dealer.
       	Unknown printer error	
	An unknown printer error has occurred.	Turn off the printer and contact your dealer.

■ = on, □ = off, ◻ = flashing

Typical Problems and Solutions

Most printer problems have simple solutions. Locate the problem in the list below, then apply the recommended solution. For more information, see "Troubleshooting" in the online *Reference Guide*.

Print quality problems

If you are having print quality problems, try the solutions offered for the problems listed in this section.

Horizontal banding

Try one or more of these solutions:

- Make sure that the printable side of the paper is face up in the sheet feeder.
- Run the Head Cleaning utility to clear any clogged ink nozzles.



Vertical misalignment

Try one or more of these solutions:

- Make sure that the printable side of the paper is face up in the sheet feeder.
- Run the Print Head Alignment utility.
- Clear the High Speed check box in your printer driver's Advanced dialog box. For Windows users, see the printer driver's online help for more information. For Macintosh users, see "Making the Media Type setting" in the online *Reference Guide*.

Color gaps

Try one or more of these solutions:

- Make sure that your paper is not damaged, dirty, or too old.
- Run the Head Cleaning utility to clear any clogged ink nozzles.
- Check the  black and  color ink out lights. If a light is flashing, replace the ink cartridge. See "Replacing Ink Cartridges" on page 30.

Blurry or smeared printout

Try one or more of these solutions:

- Make sure that the printable side of the paper is face up in the sheet feeder.
- Make sure that your paper is not damaged, dirty, or too old.
- Set the adjust lever to the “+” position, and make sure that the Media Type setting in your printer driver is correct.

Paper feed or paper jam problems

If the paper does not feed, feeds multiple pages, or the paper is jammed, remove and reload the stack of paper, then press the  load/eject button. Also, make sure the following:

- The paper is not creased or too old.
- The paper is not loaded above the arrow on the left edge guide.
- The edge guides are set correctly.
- The paper is not too thin or too rough. Use paper that meets the paper specifications for this printer. See the online *Reference Guide* for paper specifications.

To ensure that no pages are skipped and the document is printed correctly when using the double-sided printing feature, make sure that page settings in your application are correct and that the paper is loaded properly.

Canceling Printing

If the printouts are not what you expect and display incorrect or garbled characters or images, you may need to cancel the print job. To cancel the print job, follow the instructions in the appropriate section below.

For Windows 98, 95, 2000, and NT 4.0 users

When you send a print job to the printer, the Progress Meter opens.

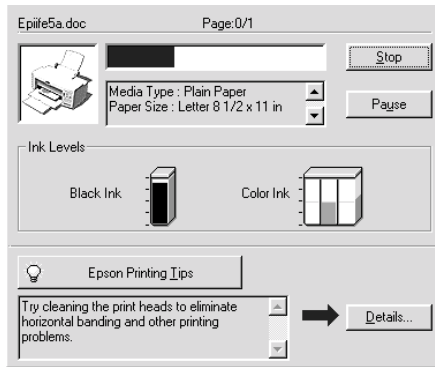

Click the Stop button to cancel the print job.

For Windows 3.1 users

When you send a print job to the printer, the Despooler opens.



Click the  Stop button to cancel the print job.

For Macintosh users

The procedure for canceling a print job from a Macintosh varies, depending on whether background printing is on or off. Refer to the appropriate section below.

When background printing is on

Follow the steps below to cancel the print job.

1. Press the  power button to turn off the printer.
2. Select EPSON Monitor3 from the application menu. EPSON Monitor3 opens.



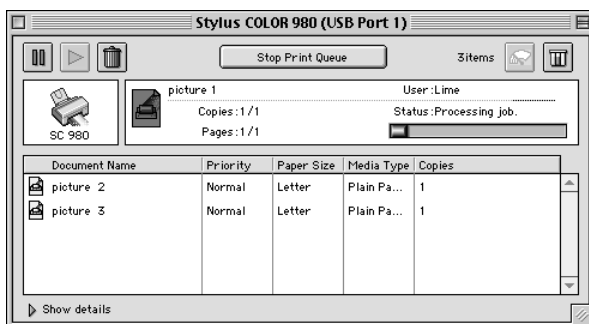

3. Select the print job that you wish to cancel in the Document Name list, then click the  Stop icon button to cancel the print job.



When background printing is off

Follow the steps below to cancel the print job.

1. Press the  power button to turn off the printer.
2. Hold down the  command key on your keyboard and press the period (.) key to cancel the print job.

Where to Get Help

If your printer is not operating properly and you cannot solve the problem using the troubleshooting information in your printer documentation, contact customer support services for assistance.

Customer support will be able to help you much more quickly if you provide them with the following information:

- Serial number of your printer
(the serial number label is on the back of the printer)
- Printer model
- Brand and model of your computer
- Printer software version
(click About in your printer driver)
- Windows version that you are using
- Software application(s) you normally use with your printer and their version number(s)

For United Kingdom and the Republic of Ireland users

If you purchased your product in the UK or the Republic of Ireland, EPSON (UK) LTD provides a range of customer services and technical support.

Support via the World Wide Web

- ❑ For information on the latest EPSON products, software drivers, on-line user guides and answers to frequently asked questions:
<http://www.epson.co.uk>
- ❑ To email EPSON Technical Support:
<http://www.epson.co.uk/support/email/>
- ❑ For a full list of EPSON Customer and Warranty Support services:
<http://www.epson.co.uk/support/>

Support via telephone

Our Customer and Warranty Support teams can be contacted by calling 0870 163 7766 in the UK or 0044 0870 163 7766 from the Republic of Ireland. They can provide the following services:

- ❑ Technical information on installing, configuring and operating your EPSON products
- ❑ Arranging for faulty EPSON products to be repaired within the warranty period

Pre Sales Enquiry Desk

Our Enquiry Desk team can be contacted by calling 0800 220546 in the UK or 1 800 409132 from the Republic of Ireland, by faxing 01442 227271 in the UK or 0044 1442 227271 from the Republic of Ireland, and via Email at info@epson.co.uk. They can provide the following information:

- ❑ Pre sales information and literature on new EPSON products (also available via our world wide web site at <http://www.epson.co.uk>)
- ❑ Where to purchase genuine EPSON consumables, accessories, and options

For Australia users

EPSON Australia wishes to provide you with a high level of customer service. In addition to this user's guide, we provide the following sources for obtaining information:

EPSON FAXBACK

EPSON FAXBACK will fax you the latest specifications and pricing for most EPSON products offered in Australia. There is also technical information including details of the latest software and drivers available. Phone (02) 9903 9075 and the system will guide you through a number of choices before faxing the information to your fax machine.

Internet URL <http://www.epson.com.au>

Access the EPSON Australia World Wide Web pages. Worth taking your modem here for the occasional surf! You can get the same information as offered on the EPSON FAXBACK and the EPSON Bulletin Board, plus more.

Your dealer

Don't forget that your dealer can often help identify and resolve problems. The dealer should always be the first call for advice on problems. They can often solve problems quickly and easily as well as give you advice on the next step to take.

EPSON Helpdesk

EPSON Helpdesk is provided as a final backup to make sure that our clients have access to advice. Operators at the Helpdesk can aid you in diagnosing hardware and software problems. They can also advise you on the latest EPSON products and where the nearest dealer or service agent is located. Many types of queries are answered here.

The Helpdesk numbers are:

Phone: 1300 361 054

Fax: (02) 9903 9189

We encourage you to have all the relevant information on hand when you ring. The more information you prepare, the faster we can help solve the problem. This information includes the *User's Guide* for your EPSON product, type of computer, operating system, application programs, and any other information you feel is required.

For India users

Contacts for information, support and services are:

World Wide Web (www.epson.co.in)

Information on product specifications, drivers for download, Frequently Asked Questions (FAQ) Product Enquiry and Technical Query are available.

Epson India Bangalore Head Office:

Phone: 080 5095465

Fax: 080 5095474

For Malaysia users

Contacts for information, support and services are:

World Wide Web (www.epson.com.my)

Information on product specifications, drivers for download, Frequently Asked Questions (FAQ) and Email Enquiry are available.

Epson Trading Shah Alam Head Office

Phone: 03 5191366

Fax: 03 5191281

For Singapore users

Sources of information, support and services available from Epson Singapore are:

World Wide Web (www.epson.com.sg)

Information on product specifications, drivers for download, Frequently Asked Questions (FAQ), Sales Enquiry, and Technical Email Support are available.

Epson HelpDesk <Phone: (065) 5863111>

Our HelpDesk team can help you with the following over the phone:

- Sales enquiry and product information
- Product usage questions or problem
- Enquiries on repair service and warranty

For Hong Kong users

To obtain technical support as well as other after-sales services, users are welcome to contact EPSON Hong Kong Limited.

Internet home page

EPSON Hong Kong has established a local home page in both Chinese and English on the Internet to provide users with the following information:

- Product information
- Answers to Frequently Asked Questions (FAQs)

- ❑ Latest versions of EPSON printer drivers

Users can access our World Wide Web home page at:
<http://www.epson.com.hk>

Electronic bulletin board system

An electronic bulletin board system (BBS) is also available to obtain printer information and the latest versions of printer drivers. You can log on to the following number for the BBS service:

BBS: (852) 2827-4244

Technical Support Hotline

You can also contact our technical staff at the following telephone and fax numbers:

Phone: (852) 2585-4399

Fax: (852) 2827-4383

For Philippines users

To obtain technical support as well as other after sales services, users are welcome to contact the EPSON Philippines Representative Office at the telephone and fax numbers below:

Phone: (632) 813-6552

Fax: (632) 813-6545

BBS: (632) 814-0595

Options and Consumable Products

Options and Consumable Products

The following options and consumable products are available for your printer.

Options

EPSON supplies the following interface cables. However, you can use any interface cable that meets these specifications. See your computer manual for any additional requirements.

- Parallel Interface Cable (shielded) C83602* from D-SUB 25-pin (computer) to 36-pin Amphenol 57 Series (printer)
- USB Interface Cable (shielded) C83623* from Series A 4-pin (computer) to Series B 4-pin (printer)

Note:

- The asterisk (*) is a substitute for the last digit of the product number, which varies by location.*
- Depending on your geographic location, one or both of these cables may not be supplied.*



Caution:

Use only interface cables which meet the specifications listed above. Using other cables not covered by EPSON warranties may cause the printer to malfunction.

Interface cards

A number of optional interfaces are available to supplement the printer's built-in interfaces. See "Using optional interface cards" in the online *Reference Guide* for more information.

If you are not sure whether you need an optional interface or if you want to know more about interfaces, contact your dealer.

Ethernet Interface Card	C82362*
	C82363*
	C82364*
	C82384*
IEEE 1394 Interface Card	C82372*

Note:

The asterisk () is a substitute for the last digit of the product number, which varies by location.*

Consumable products

The following ink cartridges and EPSON special media are available for your printer.

Ink cartridges

You can use the following cartridges with your printer.

Black ink cartridge	T003
Color ink cartridge	T005

Note:

The product numbers of ink cartridges may vary by location.

Media types

EPSON offers specially designed media for ink jet printers to meet most high-quality printing needs.

To make the Media Type setting in your printer driver, select the Media Type setting that matches the media that is loaded in the printer. To find out what Media Type you are using, find your media in the list below, and refer to the corresponding Media Type under which it is grouped (shown in larger type). For some media, there are several Media Type settings to choose from.

The available media types are listed below.

Plain Paper

Plain paper

Envelopes

EPSON Premium Ink Jet Plain Paper (A4)

S041214

360 dpi Ink Jet Paper

EPSON 360 dpi Ink Jet Paper (A4)	S041059 S041025
EPSON 360 dpi Ink Jet Paper (Letter)	S041060 S041028
EPSON Iron-On Cool Peel Transfer Paper (A4)	S041154
EPSON Iron-On Cool Peel Transfer Paper (Letter)	S041153 S041155

Photo Quality Ink Jet Paper

EPSON Photo Quality Ink Jet Paper (A4)	S041061 S041026
EPSON Photo Quality Ink Jet Paper (Letter)	S041062 S041029
EPSON Photo Quality Ink Jet Paper (Legal)	S041067 S041048
EPSON Photo Quality Ink Jet Cards (A6)	S041054
EPSON Photo Quality Ink Jet Cards (5 × 8")	S041121
EPSON Photo Quality Ink Jet Cards (8 × 10")	S041122
EPSON Photo Quality Self Adhesive Sheets (A4)	S041106
EPSON Ink Jet Note Cards A6 (with envelopes)	S041147
EPSON Ink Jet Greeting Cards 5 × 8" (with envelopes)	S041148
EPSON Ink Jet Greeting Cards 8 × 10" (with envelopes)	S041149

Matte Paper-Heavyweight

EPSON Matte Paper-Heavyweight (A4)	S041256 S041258 S041259
EPSON Matte Paper-Heavyweight (Letter)	S041257

Photo Paper

EPSON Photo Paper (A4)	S041140
EPSON Photo Paper (Letter)	S041141
EPSON Photo Paper (4 × 6")	S041134
EPSON Photo Paper (100 × 150 mm)	S041255
EPSON Photo Paper (200 × 300 mm)	S041254
EPSON Panoramic Photo Paper (210 × 594 mm)	S041145
EPSON Photo Paper Cards (A4)	S041177

Photo Quality Glossy Film

EPSON Photo Quality Glossy Film (A4)	S041071
EPSON Photo Quality Glossy Film (Letter)	S041072
EPSON Photo Quality Glossy Film (A6)	S041107
EPSON Photo Stickers 16 (A6)	S041144
EPSON Photo Stickers 4 (A6)	S041176

Ink Jet Transparencies

EPSON Ink Jet Transparencies (A4)	S041063
EPSON Ink Jet Transparencies (Letter)	S041064

Premium Glossy Photo Paper

EPSON Premium Glossy Photo Paper (A4)	S041287 S041297
EPSON Premium Glossy Photo Paper (Letter)	S041286

Note:

The availability of special media varies by location.

Printer Specifications

System Requirements

Using the printer

Refer to the appropriate section below for the minimum and recommended computer system requirements necessary to use this printer.

For Windows computers

To use this printer, you need Microsoft® Windows® 98, Windows® 95, Windows® 3.1, Windows® 2000 or Windows NT® 4.0 installed and a shielded, twisted-pair parallel cable connected. If you wish to connect your printer to a USB port, you need a Windows 98 or 2000 pre-installed PC that is equipped with a USB port and is connected to the printer via a shielded USB cable.

Your computer should also meet the following system requirements.

Minimum System Requirements	Recommended System
i386/25 MHz for Windows 3.1 i486/25 MHz for Windows 95 and NT 4.0 i486/66 MHz for Windows 98 and 2000	Pentium or better processor
16 MB RAM	32 MB RAM or more for Windows 98, 95, and 3.1 64 MB RAM or more for Windows 2000 and NT 4.0
20 MB hard disk space for Windows 98, 95, and 3.1 40 MB for Windows 2000 and NT 4.0	50 MB or more hard disk space for Windows 98, 95, and 3.1 100 MB or more for Windows 2000 and NT 4.0
VGA monitor	VGA monitor or better

Your computer dealer can help you update your system if it does not meet these requirements.

For Macintosh computers

To connect this printer to an Apple® Macintosh® computer, you must use a USB cable.

Your Macintosh must also meet the following system requirements.

Minimum System Requirements	Recommended System
Mac OS 8.1 (If using the optional IEEE1394 Interface Card, MacOS 8.6.)	Mac OS 8.5.1 or later (If using the optional IEEE1394 Interface Card, MacOS 8.6 or later.)
9 MB RAM 9 MB RAM when background printing is turned on.	21 MB RAM or more. 36 MB RAM or more when background printing is turned on.

Note:

- ❑ *The amount of available memory varies according to the number and kind of applications that are open. To see how much memory is available, click About This Computer on the Apple menu and refer to the memory size (listed in kilobytes) under "Largest Unused Block" (1,024K=1 MB).*
- ❑ *The memory requirements above are for printing on Letter size paper. These requirements may vary depending on the size of the paper, the type of application that you are using, and the complexity of the document that you want to print.*

In addition to these system and memory requirements, you need 10 MB of free hard disk space to install the printer software. To print, you also need extra hard disk space amounting to about twice the size of the file that you want to print.

Using the online Reference Guide

Refer to the appropriate section below for the minimum system requirements necessary to use the online *Reference Guide*.

For Windows computers

System	Microsoft Windows® 98, 95, 2000 or NT 4.0
CPU	i486/66 MHz for Windows 98 (Pentium or better processor recommended) i486/25 MHz for Windows 95 and NT 4.0 Pentium 133 MHz for Windows 2000 i386/25 MHz for Windows 3.1
Memory	16 MB for Windows 98, 95, 3.1, and NT 4.0 (32 MB or more recommended) 32 MB for Windows 2000
Hard disk space	2 MB to install the Reference Guide
CD-ROM drive	Double-speed (Quad-speed or faster recommended)
Display	640 × 480 pixel or 800 × 600 pixel resolution, with High Color (16 bit) or True Color (32 bit) settings
Browser	Web browser (Microsoft Internet Explorer 4.0 or later recommended)

For Macintosh computers

System	System 7.5.1 (System 7.6 or later recommended)
Memory	16 MB (32 MB or more recommended)
Hard disk space	4 MB to install the Reference Guide 15 MB to install Microsoft Internet Explorer
CD-ROM drive	Double-speed (Quad-speed or faster recommended)
Display	640 × 480 pixel or 800 × 600 pixel resolution, with High Color (16 bit) or True Color (32 bit) setting
Browser	Web browser (Microsoft Internet Explorer 4.0 or later recommended)

Printing with DOS

Installing the Printer Driver for DOS Programs

Most DOS software programs include a driver for EPSON ESC/P 2™ printers and require that you select the printer from a list to install the printer driver. To take advantage of your printer's advanced, built-in, scalable fonts and graphics handling, you must select an appropriate driver.

If your printer is not included in the list, contact your software manufacturer to obtain updated software.

If the manufacturer does not have an updated printer driver for your printer, select an alternative printer from those listed below, choosing the printers listed at the top first.

When printing in black only:

- LQ-870/1170
- LQ-570 (+)/1070(+)
- SQ-870/1070
- LQ-850
- LQ-500

When printing in black and color:

- EPSON Stylus PRO
- EPSON Stylus COLOR 500
- EPSON Stylus COLOR II
- LQ-860
- LQ-2550

Note:

The drivers for the printers listed above do not allow access to all of the features offered by the EPSON STYLUS COLOR 980, such as 720-dpi printing, 1440-dpi printing, and MicroWeave.

DOS software varies greatly. See the printing section of your software manual for information on accessing the printer driver settings.

Changing the Print Settings

You can change many print settings such as print direction and loading position. Because these settings take effect each time you turn on the printer, they are also called default settings.

The factory default settings are designed to meet the needs of most users, so you may not need to change them. The table below lists the features you can select in the default-setting mode.

Settings	Options
Font	Courier, Roman, Sans Serif, Prestige, Script, Roman T, Sans Serif H, Draft
Pitch	10 cpi, 12 cpi, 15 cpi, 17.1 cpi, 20 cpi, Proportional
Print direction	Auto, Bi-D, Uni-D
Loading position	8.5 mm, 3 mm, Others
I/F mode	Auto, Parallel, USB
Auto I/F wait time	10 seconds, 30 seconds
Network I/F mode	Off, On
Parallel I/F transfer rate	Fast, Normal
Software	ESC/P 2, IBM X24E
Auto CR (IBM mode only)	Off, On
AGM (IBM mode only)	Off, On
Auto line feed	Off, On
0 slash	0, 0 with slash

Character table	<p>Standard model: Italic, PC437, PC850, PC860, PC861, PC863, PC865, BRASCII, Abicomp, Roman 8, ISO Latin 1, PC858, ISO 8859-15</p> <p>All other models: Italic, PC437, PC437 Greek, PC850, PC852, PC853, PC855, PC857, PC866, PC869, MAZOWIA, Code MJK, ISO 8859-7, ISO Latin 1T, Bulgaria, PC774, Estonia, ISO 8859-2, PC866 LAT, PC866 UKR, PCAPTEC, PC708, PC720, PCAR864, PC860, PC861, PC863, PC865, BRASCII, Abicomp, Roman 8, ISO Latin 1, PC858, ISO 8859-15</p>
-----------------	---

Note:

Most software controls the character table and auto line feed. If your software controls these features, you may never need to set them with the control panel.



Changing the default settings

To change the printer's default settings, use the control panel buttons. Your selections are indicated by the control panel lights. Follow the steps below.

1. Make sure that the printer is turned off and that A4 or Letter size paper is loaded in the sheet feeder.
2. Hold down the  cleaning button and turn on the printer to enter the default-setting mode.

The printer loads a sheet of paper and prints a brief summary and instructions. It instructs you to select the language that you want messages printed in (English, French, German, Italian, Spanish, or Portuguese).

- Press the  cleaning button until the control panel lights indicate the language of your choice, as shown below.

Language			
English	<input type="checkbox"/>	<input type="checkbox"/>	<input checked="" type="checkbox"/>
French	<input type="checkbox"/>	<input checked="" type="checkbox"/>	<input type="checkbox"/>
German	<input type="checkbox"/>	<input checked="" type="checkbox"/>	<input checked="" type="checkbox"/>
Italian	<input checked="" type="checkbox"/>	<input type="checkbox"/>	<input type="checkbox"/>
Spanish	<input checked="" type="checkbox"/>	<input type="checkbox"/>	<input checked="" type="checkbox"/>
Portuguese	<input checked="" type="checkbox"/>	<input checked="" type="checkbox"/>	<input type="checkbox"/>

■ = On, □ = Off

- Press the  load/eject button to print the current default settings and the next set of instructions in the language that you selected. The printed instructions include submenu tables that list all of the settings that you can change and describe the appearance of the control panel lights for each selection. Use these instructions to change the settings using the control panel.
- After making your changes, exit the default-settings mode by turning off the printer.

Note:

You may exit the default-settings mode at any time by turning off the printer. Any settings that you have made remain in effect until you change them.

If you want to check the current default settings, enter the default-settings mode again and print the current default settings. The current settings are indicated with arrows.

EPSON OVERSEAS MARKETING LOCATIONS

EPSON AMERICA, INC.

20770 Madrona Ave.
P.O. Box 2842
Torrance, CA 90509-2842
Phone: (800) 922-8911
Fax: (310) 782-5220

EPSON UK LTD.

Campus 100, Maylands Avenue,
Hemel Hempstead, Herts,
HP2 7TJ, U.K.
Phone: (+44) 01442 261144
Fax: (+44) 01442 227227

EPSON DEUTSCHLAND GmbH

Zülpicher Straße 6,
40549 Düsseldorf Germany
Phone: (0211) 56030
Fax: (0211) 5047787

EPSON FRANCE S.A.

68 bis, rue Marjolin
92300, Levallois-Perret, France
Phone: 33.1.40.87.37.37
Telex: 610657

EPSON AUSTRALIA PTY. LTD.

70 GIBBES STREET, CHATSWOOD 2067 NSW.
Phone: 2-9903-9000
Fax: 2-9903-9177

EPSON SINGAPORE PTE. LTD.

No. 1 Temasek Avenue #36-00
Millenia Tower, Singapore 039192
Phone: (065) 33 77 911
Fax: (065) 33 41 185

EPSON HONG KONG LTD.

Rooms 4706-10, 47/F,
China Resources Bldg.,
26 Harbour Road, Wanchai, Hong Kong
Phone: 2585-4300
Fax: 2827-7083

EPSON TAIWAN TECHNOLOGY & TRADING LTD.

10F, No. 287 Nanking E. Road, Sec. 3,
Taipei, Taiwan, R.O.C.
Phone: (02) 717-7360
Fax: (02) 712-9164

EPSON ITALIA S.p.A.

V.le F.lli Casiraghi 427
20099 Sesto S.Giovanni
MI, Italy
Phone: 2-262331
Fax: 2-2440750

EPSON IBERICA S.A.

Av. de Roma, 18-26
08290 Cerdanyola del Valles
Barcelona, Spain
Phone: 582. 15.00
Fax: 582. 15.55

**SEIKO EPSON CORPORATION
(Hirooka Office)**

80 Harashinden, Hirooka
Shiojiri-shi, Nagano-ken
399-0785 Japan

EPSON PORTUGAL, S.A.

R. do Progresso, 471, 1° Perafita
4460 Matosinhos, Portugal
Phone: (02) 996 14 02
Fax: (02) 996 14 11

EPSON

Color Ink Jet Printer

EPSON STYLUS™ COLOR 980

Daily Use

Printed in Japan
00.XX-XX