

EPSON EXPRESSION™ 1640 XL

Color Image Scanner

All rights reserved. No part of this publication may be reproduced, stored in a retrieval system, or transmitted in any form or by any means, electronic, mechanical, photocopying, recording, or otherwise, without the prior written permission of SEIKO EPSON CORPORATION. No patent liability is assumed with respect to the use of the information contained herein. Neither is any liability assumed for damages resulting from the use of the information contained herein.

Neither SEIKO EPSON CORPORATION nor its affiliates shall be liable to the purchaser of this product or third parties for damages, losses, costs, or expenses incurred by purchaser or third parties as a result of: accident, misuse, or abuse of this product or unauthorized modifications, repairs, or alterations to this product.

SEIKO EPSON CORPORATION and its affiliates shall not be liable against any damages or problems arising from the use of any options or any consumable products other than those designated as Original EPSON Products or EPSON Approved Products by SEIKO EPSON CORPORATION.

EPSON is a registered trademark of SEIKO EPSON CORPORATION.

IBM and PS/2 are registered trademarks of International Business Machines Corporation.

Macintosh is a registered trademark of Apple Computer, Inc.

Microsoft and Windows are registered trademarks of Microsoft Corporation in the United States of America and other countries.

Presto! is a trademark of NewSoft Technology Corporation.

Adobe and Acrobat are registered trademarks and Acrobat Reader is a trademark of Adobe Systems Incorporated.

General Notice: Other product names used herein are for identification purposes only and may be trademarks of their respective companies.

Copyright © 2000 by SEIKO EPSON CORPORATION, Nagano, Japan.

Where to Find Information

■ Quick Start manual (this manual)

This guide provides you with information and instructions on how to unpack and set up your scanner. It also provides instructions on using the online documentation provided on CD-ROM.

■ Online Documentation

The CD-ROM shipped with your scanner includes the following online documentation in PDF format.

Setup Guide

The Setup Guide shows how to set up the scanner and calibrate the screen, how to install the scanner software and options, and how to use the scanner and make basic scans. It also shows how to make basic software settings and use the Start Button function.

EPSON Scan Server & EPSON TWAIN Pro Network User's Guide

Provides detailed instructions for installing and using EPSON Scan Server and EPSON TWAIN Pro Network software.

EPSON Scanner Software Reference Guide

Provides basic information about scanning and details on EPSON TWAIN Pro and other EPSON scanner software. Descriptions of EPSON TWAIN Pro also apply to EPSON TWAIN Pro Network. Finally, it offers troubleshooting tips and customer support information.

■ Information on EPSON TWAIN Pro and EPSON TWAIN Pro Network

Online help provides you with detailed information on EPSON TWAIN Pro and EPSON TWAIN Pro Network. Click the **?** button in the **EPSON TWAIN Pro** or **EPSON TWAIN Pro Network** dialog box.

■ Information on PageManager and other Software

See the PageManager for EPSON, and other software documentation provided on the EPSON Scanner Software CD-ROM.

■ Contents

Safety Instructions	4
ENERGY STAR Compliance	4
Warnings, Cautions, and Notes	5
System Requirements	5
For PCs	5
For Macintosh	6
Unpacking the Scanner	7
Attaching the Document Guide Strip	8
Scanner Parts	10
Setting Up the Scanner	11
Choosing a Place for the Scanner	11
Releasing the Transportation Lock	11
Plugging In the Scanner	12
Initialization	12
Connecting the Scanner to Your Computer	13
Connecting the Scanner to Your Computer Using the SCSI Interface . .	13
Connecting the Scanner to Your Computer Using the USB Interface . .	19
Using the Online Manuals	21
Installing the Adobe Acrobat Reader	22
Accessing the Online Manuals	22
Customer Support	23

■ Safety Instructions

Read all these instructions and save them for later reference. Follow all warnings and instructions marked on the scanner.

- Unplug the scanner before cleaning. Clean with a damp cloth only. Do not spill liquid on the scanner.
- Do not place the scanner on an unstable surface, or near a radiator or heat source.
- Use only the type of power source indicated on the scanner's label.
- Connect all equipment to properly grounded power outlets. Avoid using outlets on the same circuit as photocopiers or air control systems that regularly switch on and off.
- Do not allow the power cord become damaged or frayed.
- If you use an extension cord with the scanner, make sure the total ampere rating of the devices plugged into the extension cord does not exceed the cord's ampere rating. Also, make sure the total ampere rating of all devices plugged into the wall outlet does not exceed the wall outlet's ampere rating.
- Except as specifically explained in the documentation provided with this scanner, do not attempt to service the scanner yourself.
- Unplug the scanner and refer servicing to qualified service personnel under the following conditions:

If the power cord or plug is damaged; if liquid has entered the scanner; if the scanner has been dropped or the case damaged; if the scanner does not operate normally or exhibits a distinct change in performance. (Do not adjust controls that are not covered by the operating instructions.)
- If you plan to use the scanner in Germany, observe the following:

To provide adequate short-circuit protection and over-current protection for this scanner, the building installation must be protected by a 10 or 16 Amp circuit breaker.

■ ENERGY STAR Compliance

As an ENERGY STAR Partner, EPSON has determined that this product meets the ENERGY STAR guidelines for energy efficiency.

The International ENERGY STAR Office Equipment Program is a voluntary partnership with the computer and office equipment industry to promote the introduction of energy-efficient personal computers, monitors, printers, fax machines, copiers, and scanners, in an effort to reduce air pollution caused by power generation.



■ Warnings, Cautions, and Notes

**Warnings:**

must be followed carefully to avoid bodily injury.

**Cautions:**

must be observed to avoid damage to your equipment.

Notes:

contain important information and useful tips on the operation of your scanner.

■ System Requirements

Before installing the scanner software, make sure that your system meets the following requirements.

■ For PCs

■ For Windows SCSI users

Scanner:	EPSON EXPRESSION 1640XL
System:	Microsoft® Windows® 2000, Windows® 98, Windows® 95, or Windows NT® 4.0
Interface:	Adaptec® SCSI adapter
Display:	VGA or higher resolution monitor 640 × 480 screen resolution (800 × 600 or higher recommended), and 256 color (65,000 color or higher recommended)

Note:

Color and tone reproduction are subject to the display capability of your computer system, including the video card, display monitor, and software. See the product documentation for details.

■ For Windows USB users

Scanner:	EPSON EXPRESSION 1640XL
System:	Microsoft® Windows® 2000 or Windows® 98 preinstalled
Interface:	The computer's USB port (TYPE A receptacle)
Display:	VGA or higher resolution monitor 640 × 480 screen resolution (800 × 600 or higher recommended), and 256 color (65,000 color or higher recommended)

Note:

Color and tone reproduction are subject to the display capability of your computer system, including the video card, display monitor, and software. See the product documentation for details.

■ For Macintosh

■ For Macintosh SCSI users

Scanner:	EPSON EXPRESSION 1640XL
System:	Apple® Macintosh® with a PowerPC processor (excluding the PowerBook 100) running OS 8.0 or later
Interface:	SCSI adapter
Display:	Color Monitor, 640 × 480 screen resolution (or higher recommended), and 256 color (32,000 color or higher recommended)

Note:

Color and tone reproduction are subject to the display capability of your computer system, including the video card, display monitor, and software. See the product documentation for details.

■ For Macintosh USB users

Scanner: EPSON EXPRESSION 1640XL

System: A USB-equipped Macintosh with OS 8.5 or later

Note:

The included software cannot be used with the Multiple Users function of Mac OS 9.

Interface: USB port

Display: Color Monitor, 640 × 480 screen resolution (or higher recommended), and 256 color (32,000 color or higher recommended)

Note:

Color and tone reproduction are subject to the display capability of your computer system, including the video card, display monitor, and software. See your product documentation for details.

■ Unpacking the Scanner

Your EPSON EXPRESSION 1640XL comes shipped with CD-ROMs which include the driver software that runs your scanner, and some additional items, depending on the place of purchase.

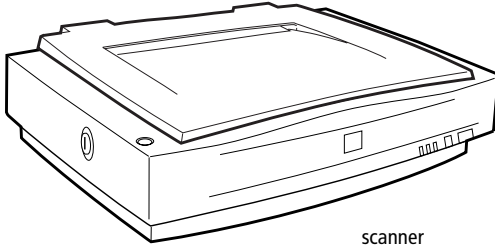

scanner



power cord

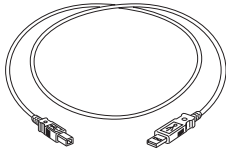

USB interface cable

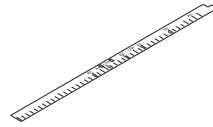

Document Guide Strip

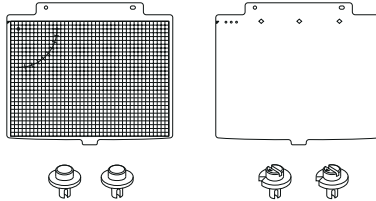

Document Guide and adjust pins

■ Attaching the Document Guide Strip

The document guide strip is designed to help you properly align your documents when placing them on the document table.

Peel off the backing from the document guide strip, then place the strip directly on the horizontal ruler of the document table as shown in the illustration.

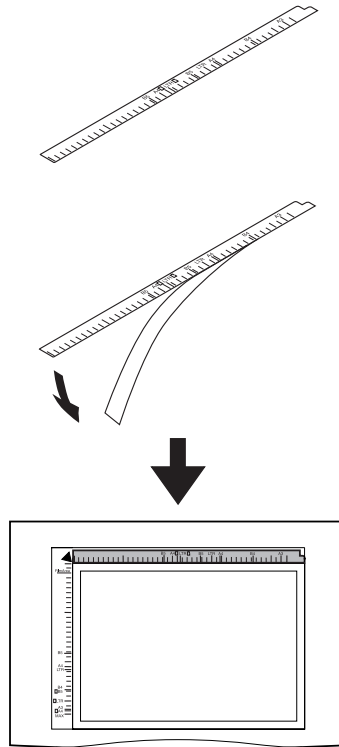

Note:

Be sure to remove the document guide strip from the document table before using the optional Automatic Document Feeder.

Scanner Parts

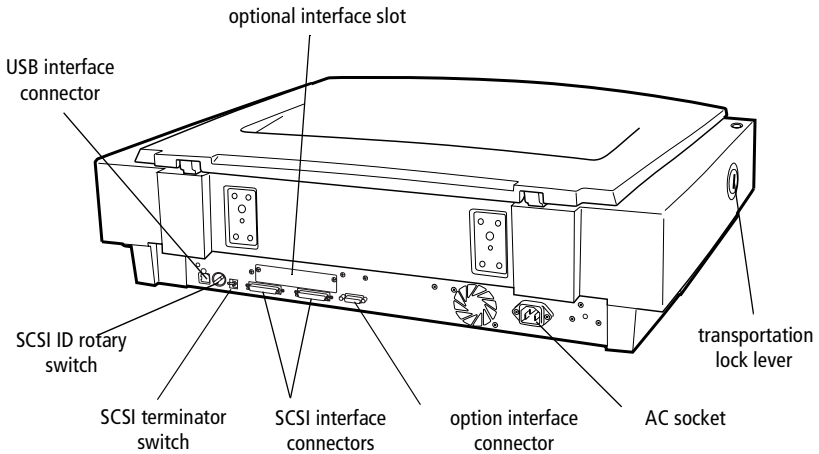
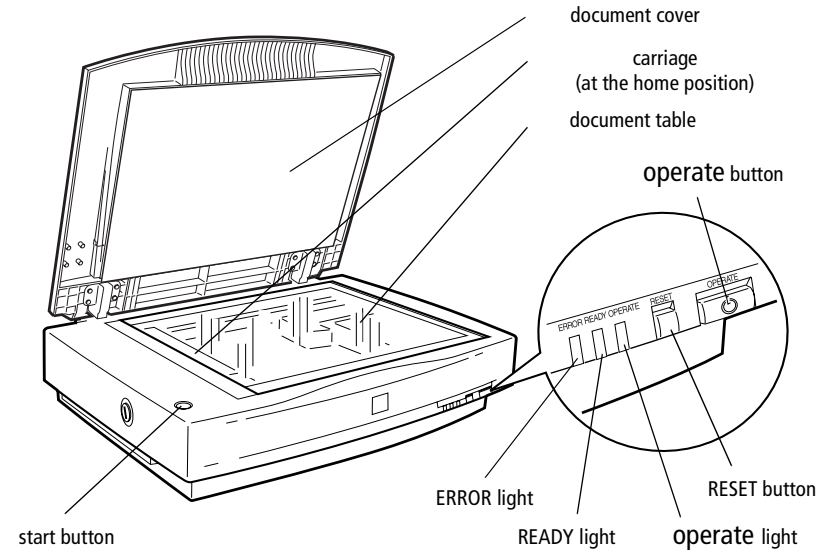

■ Setting Up the Scanner

■ Choosing a Place for the Scanner

Follow the guidelines below when selecting a location for your scanner:

- Place the scanner on a flat, stable surface. The scanner will not operate properly if it is tilted at an angle.
- Place the scanner close enough to the computer for the interface cable to reach it easily.
- Place the scanner near a wall outlet where the power cord can be easily unplugged.
- Allow space behind the scanner for the cables, and space above the scanner so that you can fully raise the document cover.
- Keep the scanner away from high temperatures, humidity and excessive dirt or dust. Also avoid using or storing the scanner in places subject to rapid changes of temperature and humidity.
- Keep the scanner away from direct sunlight and strong light sources.
- Avoid places subject to shocks and vibrations.

■ Releasing the Transportation Lock

When the scanner is unpacked, the carriage is locked in the home position to prevent damage from shaking or vibration during transportation. You must release the transportation lock before you can use the scanner.

1. Place the scanner on a flat, stable surface with its left side facing you.
2. Turn the transportation lock to the unlocked position using a coin or a similar object, as shown below.

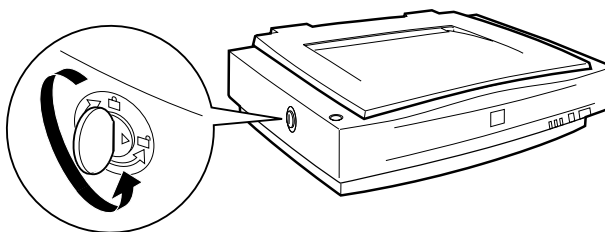

Note:

Before you transport the scanner or store it for an extended period of time, secure the carriage by turning the transportation lock back to the locked position. For more information, see “Maintenance and Troubleshooting” in your Online Reference Guide.

■ Plugging In the Scanner

1. Make sure that the scanner is turned off. The scanner is off when the  **OPERATE** button is raised.

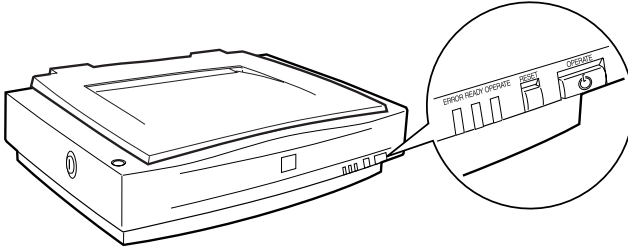

2. If the power cord is not attached to the scanner, connect it to the AC inlet on the back of the scanner, and plug the other end into a properly grounded electrical outlet.

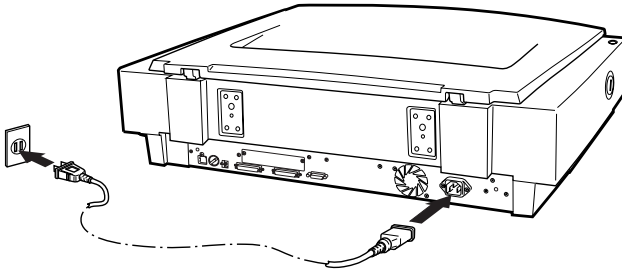

Caution:

It is not possible to change the scanner's voltage. If the label on the back of the scanner does not show the correct voltage for your location, contact your dealer. Do not plug in the power cord.

■ Initialization

By observing the scanner's initialization, you can make sure that the scanner is operating properly before you connect it to your computer.

1. Open the document cover so you can see the operation of the scanner during initialization.

2. Turn on the scanner by pressing the  **OPERATE** button.

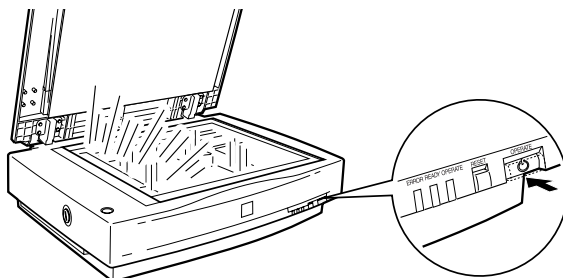

While the scanner initializes, the fluorescent lamps on the carriage flash. If the carriage is not at the home position (the left of the scanner), it moves to the home position.

When the scanner has completed its initialization, the **READY** light comes on. If the scanner does not work as described, turn it off. Make sure that the power cord is firmly plugged in and that you have released the transportation lock screw, then turn it on again.



Caution:

Whenever you turn off the scanner, wait at least 10 seconds before turning it back on. Rapidly turning the scanner on and off can damage the scanner.

■ Connecting the Scanner to Your Computer

■ Connecting the Scanner to Your Computer Using the SCSI Interface

For instructions on connecting the scanner to your computer using the SCSI interface, read this section.

Note for Macintosh Users:

Be sure to install the scanner software before connecting the scanner to your computer. See Chapter 3, "Installing the Scanner Software for Macintosh" in your online Setup Guide for details.

■ For PC users:

Unless your PC already has a SCSI board installed, you need to install one, along with SCSI driver software. Install the SCSI board according to the directions included with it.

If your PC has a SCSI board up and running, connect the scanner as described in the next section.

Note:

You will need to install the SCSI driver that is normally included with Windows 2000, 98, 95, or NT (see your system documentation for instructions), or the driver described in the SCSI board installation documentation.

■ **For Macintosh users:**

Your Macintosh may or may not have SCSI ports, depending on which model you own. If you have a Macintosh that does not have a SCSI port, you need to install a SCSI board and driver. Follow the directions below to connect your scanner and computer.

Note:

The latest driver may be available for download from the Web site of the SCSI board manufacturer.

■ **Setting the SCSI ID number**

scanner's default SCSI ID number is 2.

The SCSI ID rotary switch is located at the back of the scanner.

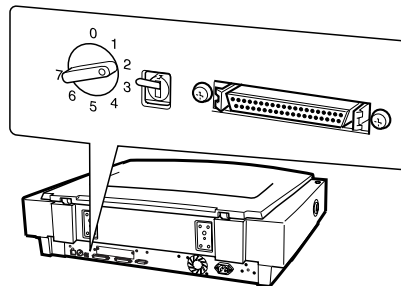

If you add the scanner to a system in which one of your SCSI devices already has a SCSI ID of 2, change the ID number to an unused number using the rotary switch. See the table below as a guide.

ID	Availability	Description
0	Not available for Macintosh	Used for hard disk
	Not recommended for Windows	Usually used for hard disk
1	Not recommended	Usually used for hard disk
2		Factory setting of the scanner

3		Not available if your Macintosh has a built-in CD-ROM
4		
5		
6		
7	Not available for Macintosh	Always used for the Macintosh itself
	May not be available for Windows	Usually used for the SCSI board



Caution:

Do not set the SCSI ID to an ID number that is already assigned to another device otherwise the computer, scanner, and other devices will not operate properly.

■ **Setting the terminator switch**

The scanner has a built-in terminator, which allows SCSI devices to communicate properly with each other. You may need to change the terminator switch setting according to your computer system.

Note:

Do not use an external terminator.

The terminator switch is located at the back of the scanner.

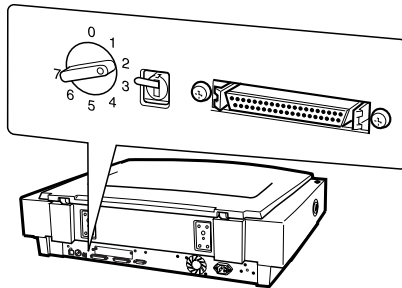

Only the scanner is connected

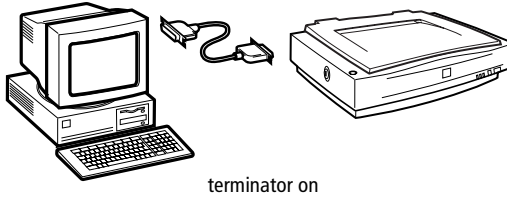

The scanner is the last device in the daisy chain

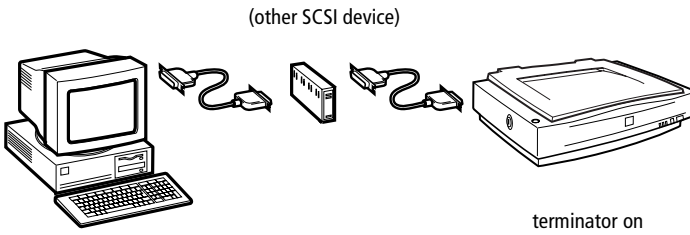

The scanner is in the middle of the daisy chain

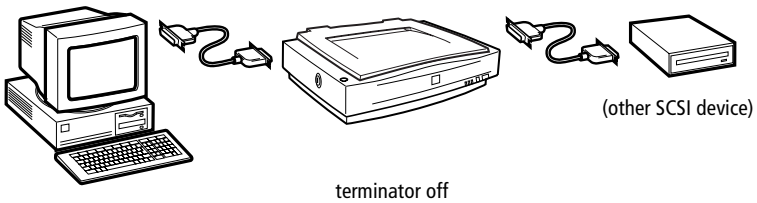

■ Connecting the scanner

Connect the scanner to your computer or to another SCSI device as follows:

Note:

The combination of connectors on the SCSI interface cable you need varies depending on the maker of your SCSI device and SCSI interface board.

1. Make sure the scanner, computer, and all other SCSI devices are turned off and unplugged from the power source.



Caution:

Do not connect the scanner to the computer or other devices while they are turned on as damage may occur.

2. Connect one end of the interface cable to one of the scanner SCSI connectors until the locks on both sides snap in.

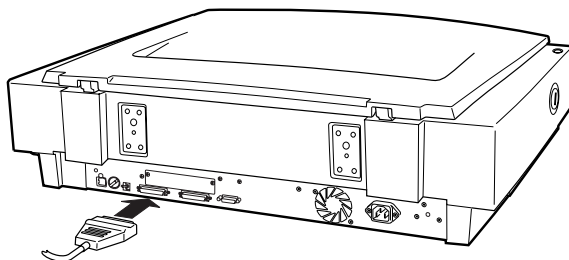

Note:

- *To connect the scanner to a PC or any other SCSI device, the total length of cable in the daisy chain must not exceed 3 meters; otherwise the system may not work properly.*
- *Make sure no other interface is used.*

3. Connect the other end of the cable to the SCSI port of your computer or another SCSI device.

Note:

The SCSI port on the Macintosh is the larger port with the SCSI icon over it.

4. Plug in the power cords of your computer, scanner, and other external SCSI devices.

Note:

Before turning on your system, be sure to read “Power-on sequence” following.

■ Power-on sequence

Keep the following in mind every time you turn on your computer and SCSI devices, including the scanner.

- Be sure to turn on the SCSI device which is connected at the farthest end of the daisy chain first, then the second farthest and so on, until finally your computer. If you attempt to use a SCSI device which has been turned on after the computer, it may not work properly, or the computer may not work properly.

- **For Windows 2000, 98, or 95 users:**
The first time you turn on the computer after turning on the scanner, one of the following dialog boxes or similar may appear.



Windows 95



Windows 98



Windows 2000

If you see one of these, follow the installation instructions in Chapter 3, “Installing the Software,” in your online Setup Guide, then see “Power-off sequence” following.

■ Power-off sequence

Keep the following in mind every time you turn off your computer and SCSI devices.

- When you are finished using your system, turn off your computer first, then the scanner and other SCSI devices in reverse order of the power-on sequence.
- While using your computer, do not turn off any SCSI device which has a terminator that is active (on).
- Do not turn the scanner off and back on while using your computer, otherwise the scanner may not work properly.

When the connection is complete, you need to install the scanner software. See Chapter 3, “Installing the Software,” in your online Setup Guide for instructions.

■ Connecting the Scanner to Your Computer Using the USB Interface

Your PC must have been purchased with Windows 2000 or Windows 98 preinstalled, and have a working USB port.

Your Macintosh computer must be running system 8.5 or later and have a built-in USB port.

Note for Macintosh Users:

Be sure to install the scanner software before connecting the scanner to your Macintosh. See Chapter 3, "Installing the Scanner Software for Macintosh," in your online Setup Guide for details.

■ Understanding USB connections

USB Cables

USB cables enable you to connect or remove peripherals to and from your computer easily, without having to shut down and restart the system each time a peripheral is plugged in or unplugged. You do not have to set an ID number or a terminator.

Note:

Do not connect or disconnect USB cables when the scanner is in use.

USB cables have 2 different connectors at each end.

Type A connects to your computer.



Type B connects to your scanner.



USB hub

You can also use a USB hub, allowing you to increase the number of USB ports and therefore connect several peripherals.

Note:

If you connect your scanner through more than one hub, your system may not work properly. In this case, try connecting the scanner directly to the computer's USB port. Also, your system may not work properly if you use a USB cable other than that supplied by EPSON.

■ Connecting the scanner

To connect the scanner to your computer or USB hub:

1. Connect one end of the cable (Type B) to the USB port on the back of the scanner.

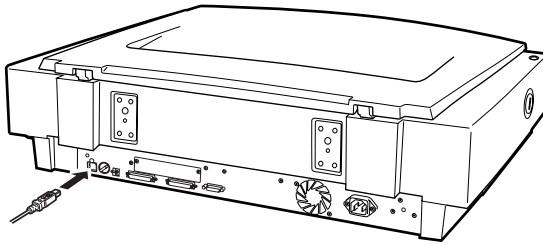
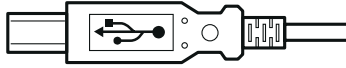

2. Connect the other end of the cable (Type A) to the USB port on your computer, or USB hub.

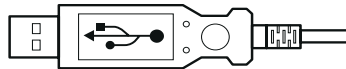

Note:

- *USB cables enable you to connect the scanner whether your computer is on or off. If you connect the scanner while your computer is on, the “Add New Hardware Wizard” dialog box (Windows) or a message telling you that the scanner driver needs to be installed (Macintosh) will appear. When this happens, follow the instructions in Chapter 3 in the online Setup Guide, then install the software.*
- *Connect the USB cable to your computer, then install or start the scanner software. Do not connect or disconnect the USB cable while the scanner software is open.*
- *Make sure no other interface is used.*

■ Using the Online Manuals

The CD-ROM shipped with your scanner includes three different online manuals in PDF format (PDF = Portable Document Format). PDF files can be used on various platforms (e.g. Windows, Macintosh, Unix etc.) and are electronic manuals with the same layout, illustrations, tables etc. to be found in a printed manual. You can display the online manuals on your computer screen and print them on any connected printer, if required.

The following three manuals are available:

- **Setup Guide**

The Setup Guide shows how to set up the scanner and calibrate the screen, how to install the scanner software and options, and how to use the scanner and make basic scans. It also shows how to make basic software settings and use the Start Button function.
- **EPSON Scanner Server & EPSON TWAIN Pro Network User's Guide**

Provides detailed instructions for installing and using EPSON Scan Server and EPSON TWAIN Pro Network software.
- **EPSON Scanner Software Reference Guide**

Provides basic information about scanning and details on EPSON TWAIN Pro and other EPSON scanner software. Descriptions of EPSON TWAIN Pro also apply to EPSON TWAIN Pro Network. Finally, it offers troubleshooting tips and customer support information.

To access these manuals you need to install the Adobe® Acrobat® Reader™ software, which is also provided on the CD-ROM.

Note:

The Adobe Acrobat Reader program is an easy-to-use application program for displaying and printing online manuals. It offers a wide range of features which allow you to use the online manuals without difficulty to find any desired information. You can read the information online on your computer screen or print it out for later reference. If you need complete information on the Adobe Acrobat Reader, refer to its online help.

If the Acrobat Reader is already installed on your system, you can skip the next section.

Note:

If you are not sure whether the Acrobat Reader is installed on your system, please contact your system administrator or double-click on the menu item for reading the online manual in the setup program. If the Adobe Acrobat Reader is not installed on your system, the manual will not open and an error message will be displayed.

■ Installing the Adobe Acrobat Reader

1. Insert the EPSON Online manual CD-ROM into your computer's CD-ROM drive.

Windows 95/98/NT 4.0/2000:

The setup program on the CD-ROM will be started automatically and displays the start screen. If the setup program is not started automatically, click the **Start** button, then click **Run** and enter the command **E:\Start.exe** to start the setup program.

Note:

*If your CD-ROM drive has a drive letter other than **E**, substitute the appropriate letter.*

Macintosh:

Display the contents of the CD-ROM on your computer screen and branch to the Acrobat Reader folder.

2. Select the preferred language.

3. **Windows 95/98/NT 4.0/2000:**

Select **Online manuals**, followed by **Install Acrobat Reader** and follow the on-screen instructions.

Macintosh:

Start the **Installer** and follow the on-screen instructions.

After the Acrobat Reader has been installed on your system, you can access the online manuals.

■ Accessing the Online Manuals

The setup program on the CD-ROM offers two possibilities to access the online manuals: from the CD-ROM or from your computer hard disk.

Note:

Before you can access the online manuals from your hard disk, you first have to install them on the hard disk.

1. Insert the EPSON Online manual CD-ROM into your computer's CD-ROM drive.

Windows 95/98/NT 4.0/2000:

The setup program on the CD-ROM will be started automatically and displays the start screen. If the setup program is not started automatically, click the **Start** button, then click **Run** and enter the command **E:\Start.exe** to start the setup program.

Note:

*If your CD-ROM drive has a drive letter other than **E**, substitute the appropriate letter.*

Macintosh:

Display the contents of the CD-ROM on your computer screen and branch to the Acrobat Reader folder.

2. Select the preferred language.
3. **Windows 95/98/NT 4.0/2000:**

Select **Online manuals**. The setup program displays the names of the available online manuals. Select the preferred online manual.

 - Select **manual name - Read** if you wish to open the manual from the CD-ROM. The Acrobat Reader will be started automatically and the online manual opened.
 - If you wish to copy the online manuals to your system's hard disk, select **manual name - PC installation**.

Note:

You can delete the manuals from the hard disk at a later date if required.

Once the manuals have been installed on the hard disk, proceed as follows: Click the **Start** button, point to **Programs**, then point to **EPSON**. Click on the name of an online manual. The Acrobat Reader will be started automatically and the online manual opened.

Macintosh:

Start the **Installer** and double-click on the preferred online manual to open the manual from the CD-ROM. To install the online manual on your computer's hard disk, select the manual and drag it onto your computer's desktop.

■ Customer Support

EPSON's Service and Support hotline is available should you require urgent help. You will find the telephone number and further important information for your country in the Service and Support brochure provided with your scanner.