

# Where to Find Information

## **Setup**

This guide will help you set up and begin using your printer. It includes information on setting up your printer and installing the printer software.

## **Standalone Operation Guide**

This guide provides information for direct printing, troubleshooting tips and customer support information.

## **Reference Guide**

The Reference Guide contained on the CD-ROM provides detailed information about printing with a computer, maintenance, and problem solving.

# EPSON®

Color Inkjet Printer

## EPSON STYLUS™ PHOTO R320 Series

All rights reserved. No part of this publication may be reproduced, stored in a retrieval system, or transmitted in any form or by any means, electronic, mechanical, photocopying, recording, or otherwise, without the prior written permission of Seiko Epson Corporation. The information contained herein is designed only for use with this Epson printer. Epson is not responsible for any use of this information as applied to other printers.

Neither Seiko Epson Corporation nor its affiliates shall be liable to the purchaser of this product or third parties for damages, losses, costs, or expenses incurred by the purchaser or third parties as a result of accident, misuse, or abuse of this product or unauthorized modifications, repairs, or alterations to this product, or (excluding the U.S.) failure to strictly comply with Seiko Epson Corporation's operating and maintenance instructions.

Seiko Epson Corporation shall not be liable for any damages or problems arising from the use of any options or any consumable products other than those designated as Original Epson Products or Epson Approved Products by Seiko Epson Corporation.

Seiko Epson Corporation shall not be held liable for any damage resulting from electromagnetic interference that occurs from the use of any interface cables other than those designated as Epson Approved Products by Seiko Epson Corporation.

EPSON® is a registered trademark and EPSON Stylus™ is a trademark of Seiko Epson Corporation.

PRINT Image Matching™ and the PRINT Image Matching logo are trademarks of Seiko Epson Corporation. Copyright © 2001 Seiko Epson Corporation. All rights reserved.

USB DIRECT-PRINT™ and the USB DIRECT-PRINT logo are trademarks of Seiko Epson Corporation. Copyright © 2002 Seiko Epson Corporation. All rights reserved.

The BLUETOOTH™ trademarks are owned by Bluetooth SIG, Inc., U.S.A. and licensed to Seiko Epson Corporation.

Microsoft® and Windows® are registered trademarks of Microsoft Corporation.

Apple® and Macintosh® are registered trademarks of Apple Computer, Inc.

Part of the photo data stored on the Printer Software CD-ROM is licensed from Design Exchange Co., Ltd. Copyright © 2000 Design Exchange Co., Ltd. All rights reserved.

DPOF™ is a trademark of CANON INC., Eastman Kodak Company, Fuji Photo Film Co., Ltd. and Matsushita Electric Industrial Co., Ltd.

Zip® is a registered trademark of Iomega Corporation.

SD™ is a trademark.

Memory Stick, Memory Stick Duo, Memory Stick PRO, and Memory Stick PRO Duo are trademarks of Sony Corporation.

xD-Picture Card™ is a trademark of Fuji Photo Film Co.,Ltd.

*General Notice: Other product names used herein are for identification purposes only and may be trademarks of their respective owners. Epson disclaims any and all rights in those marks.*

Copyright © 2005 by Seiko Epson Corporation. All rights reserved.

---

# Contents

<b>Safety Instructions</b> .....	<b>6</b>
Important Safety Instructions .....	6
Warnings, Cautions, and Notes .....	13
<b>Printer Parts and Control Panel Functions</b> .....	<b>14</b>
Printer Parts .....	14
Control Panel .....	16
<b>Direct Printing Basics</b> .....	<b>19</b>
Introduction .....	19
Loading Single Sheets of Paper .....	19
Loading Memory Cards .....	21
Basic Printing .....	24
Printing on CD/DVD .....	31
Canceling Printing Using the Control Panel .....	38
Ejecting Memory Cards .....	38
<b>Various Setting</b> .....	<b>39</b>
Advanced Printing .....	39
More Options .....	42
Exif Print and PRINT Image Matching .....	50
DPOF Settings .....	53
PRINT Image Framer .....	54
Digital Camera Direct Printing .....	56
Storing and Loading the Settings .....	57
Backup .....	59
Printing with an External Device .....	60
<b>Replacing Ink Cartridges</b> .....	<b>63</b>
Checking the Ink Supply .....	63
Replacing an Ink Cartridge .....	64

<b><i>Improving Print Quality</i></b> .....	<b>70</b>
Checking the Print Head Nozzles .....	70
Cleaning the Print Head .....	71
Aligning the Print Head .....	73
Cleaning the Printer .....	76
Transporting the Printer .....	77
<b><i>Troubleshooting</i></b> .....	<b>79</b>
Error/Warning Display .....	79
Print Quality Problems .....	82
Printout Problems Not Related to Print Quality .....	85
Paper Does Not Feed Correctly .....	85
Printer Does Not Print .....	89
Print Head Carriage Problem .....	90
Printing Problems when Using the Bluetooth Photo Print Adapter .....	91
Communication Error .....	91
Canceling Printing .....	93
<b><i>Customer Support</i></b> .....	<b>94</b>
Contacting Customer Support .....	94
Technical Support Web Site .....	95
<b><i>Options and Consumable Products</i></b> .....	<b>96</b>
Options .....	96
Consumable products .....	96
<b><i>Printer Specifications</i></b> .....	<b>98</b>
Printer Specifications .....	98
External Storage Devices .....	107
Standards and Approvals .....	108

# ***Safety Instructions***

---

## ***Important Safety Instructions***

Read all of the instructions in this section before using your printer. Also, be sure to follow all warnings and instructions marked on the printer.

### ***When setting up your printer***

Observe the following when setting up the printer:

- Do not block or cover the vents and openings in the printer.
- Use only the type of power source indicated on the printer's label.
- Use only the power cord that comes with this product. Use of another cord may result in fire or electric shock.
- This product's power cord is for use with this product only. Use with other equipment may result in fire or electric shock.
- Be sure your AC power cord meets the relevant local safety standard.
- Avoid using outlets on the same circuit as photocopiers or air control systems that regularly switch on and off.
- Avoid electrical outlets controlled by wall switches or automatic timers.
- Keep the entire computer system away from potential sources of electromagnetic interference, such as loudspeakers or the base units of cordless telephones.

- ❑ Do not use a damaged or frayed power cord.
- ❑ If you use an extension cord with the printer, make sure that the total ampere rating of the devices plugged into the extension cord does not exceed the cord's ampere rating. Also, make sure that the total ampere rating of all devices plugged into the wall outlet does not exceed the wall outlet's ampere rating.
- ❑ Do not attempt to service the printer yourself.
- ❑ Unplug the printer and refer servicing to qualified service personnel under the following conditions:

The power cord or plug is damaged; liquid has entered the printer; the printer has been dropped or the casing damaged; the printer does not operate normally or exhibits a distinct change in performance.

- ❑ When connecting this product to a computer or other device with a cable, ensure the correct orientation of the connectors. Each connector has only one correct orientation. Inserting a connector in the wrong orientation may damage both devices connected by the cable.
- ❑ If you plan to use the printer in Germany, the building installation must be protected by a 10 or 16 amp circuit breaker to provide adequate short-circuit protection and over-current protection for this printer.

## ***When choosing a place for the printer***

Observe the following when choosing a place for the printer:

- ❑ Place the printer on a flat, stable surface that extends beyond the base of the printer in all directions. If you place the printer by the wall, leave more than 10 cm between the back of the printer and the wall. The printer will not operate properly if it is tilted at an angle.
- ❑ When storing or transporting the printer, do not tilt it, stand it on its side, or turn it upside down. Otherwise, ink may leak from the cartridges.
- ❑ Leave enough space in front of the printer for the paper to be fully ejected.
- ❑ Avoid places subject to rapid changes in temperature and humidity. Also, keep the printer away from direct sunlight, strong light, or heat sources.
- ❑ Avoid places subject to dust, shocks, or vibrations.
- ❑ Leave enough room around the printer to allow for sufficient ventilation.
- ❑ Place the printer near a wall outlet where the plug can be easily unplugged.



## ***When using the printer***

Observe the following when using the printer:

- ❑ Do not insert objects through the slots in the printer.
- ❑ Take care not to spill liquid on the printer.
- ❑ Do not put your hand inside the printer or touch the ink cartridges during printing.
- ❑ Do not move the print head by hand; otherwise, you may damage the printer.
- ❑ Always turn the printer off using the  power button. When this button is pressed, the LCD panel goes blank. Do not unplug the printer or turn off the power to the outlet until the LCD panel goes blank.
- ❑ Before transporting the printer, make sure that the print head is in the home (far right) position and the ink cartridges are in place.
- ❑ Leave the ink cartridges installed. Removing the cartridges can dehydrate the print head and may prevent the printer from printing.

## ***When using a memory card***

- ❑ Do not remove the memory card or turn off the printer while the computer and the memory card are communicating (when the memory card lights is flashing).
- ❑ The methods for using memory cards vary according to card type. Be sure to refer to the documentation packaged with your memory card for details.
- ❑ Use only memory cards compatible with the printer. Refer to Loading Memory Cards.

## ***When using LCD panel or the preview monitor***

- ❑ The LCD panel or preview monitor may contain a few small bright or dark spots. These are normal and do not mean that they are damaged in any way.
- ❑ Only use a dry, soft cloth to clean the LCD panel or the preview monitor. Do not use liquid or chemical cleansers.
- ❑ If the LCD panel on your printer's control panel or preview monitor is damaged, contact your dealer. If the liquid crystal solution gets on your hands, wash them thoroughly with soap and water. If the liquid crystal solution gets into your eyes, flush them immediately with water. If discomfort or vision problems remain after a thorough flushing, see a doctor immediately.

## ***When using the optional Bluetooth Photo Print Adapter***

Refer to the Bluetooth Photo Print Adapter's documentation for the safety instructions.

## ***When handling the ink cartridges***

Observe the following when handling the ink cartridges:

- ❑ Keep ink cartridges out of the reach of children. Do not allow children to drink from or otherwise handle the cartridges.
- ❑ Do not shake the ink cartridges; this can cause leakage.
- ❑ Be careful when you handle used ink cartridges, as there may be some ink remaining around the ink supply port. If ink gets on your skin, wash the area thoroughly with soap and water. If ink gets into your eyes, flush them immediately with water. If discomfort or vision problems remain after a thorough flushing, see a doctor immediately.
- ❑ Do not remove or tear the label on the cartridge; this can cause leakage.
- ❑ Install the ink cartridge immediately after you remove it from its package. If you leave a cartridge unpacked for a long time before using it, normal printing may not be possible.
- ❑ Do not use an ink cartridge beyond the date printed on the cartridge carton: otherwise, it may result in reduced print quality. For best results, use up the ink cartridges within six months of first installing them.
- ❑ Do not dismantle the ink cartridges or try to refill them. This could damage the print head.

- ❑ After bringing an ink cartridge inside from a cold storage site, allow it to warm up at room temperature for at least three hours before using it.
- ❑ Store ink cartridges in a cool, dark place.
- ❑ Do not touch the green IC chip on the back of the cartridge. Doing so may prevent normal operation and printing.
- ❑ The IC chip on this ink cartridge retains a variety of cartridge related-information such as the amount of ink remaining, so that the cartridge may be removed and reinserted freely. However, each time the cartridge is inserted, some ink is consumed because the printer automatically performs a reliability check.
- ❑ If you remove an ink cartridge for later use, protect the ink supply area from dirt and dust and store it in the same environment as the printer. A valve in the ink supply port makes covers or plugs unnecessary, but the ink may stain items that come into contact with this area of the cartridge. Do not touch the ink supply port or the surrounding area.

## ENERGY STAR® Compliance



As an ENERGY STAR® Partner, Epson has determined that this product meets the ENERGY STAR® guidelines for energy efficiency.

The International ENERGY STAR® Office Equipment Program is a voluntary partnership with the computer and office equipment industry to promote the introduction of energy-efficient personal computers, monitors, printers, fax machines, copiers, scanners, and multifunction devices in an effort to reduce air pollution caused by power generation. Their standards and logos are uniform among participating nations.

---

## Warnings, Cautions, and Notes



### **Warnings**

*must be followed carefully to avoid bodily injury.*



### **Cautions**

*must be observed to avoid damage to your equipment.*

### **Notes**

*contain important information and useful tips on the operation of your printer.*

# Printer Parts and Control Panel Functions

---

## Printer Parts

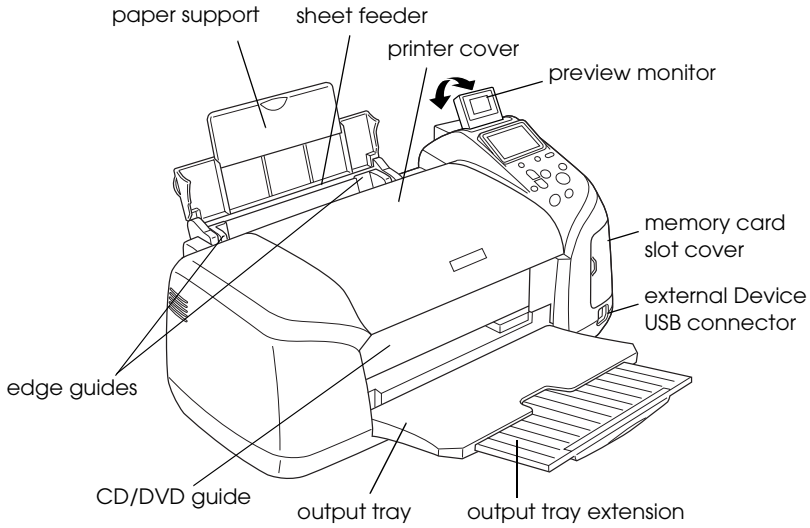

## Memory card slot (enlarged figure)

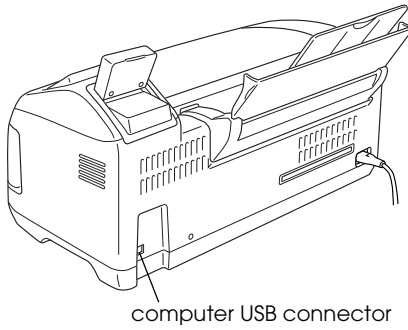
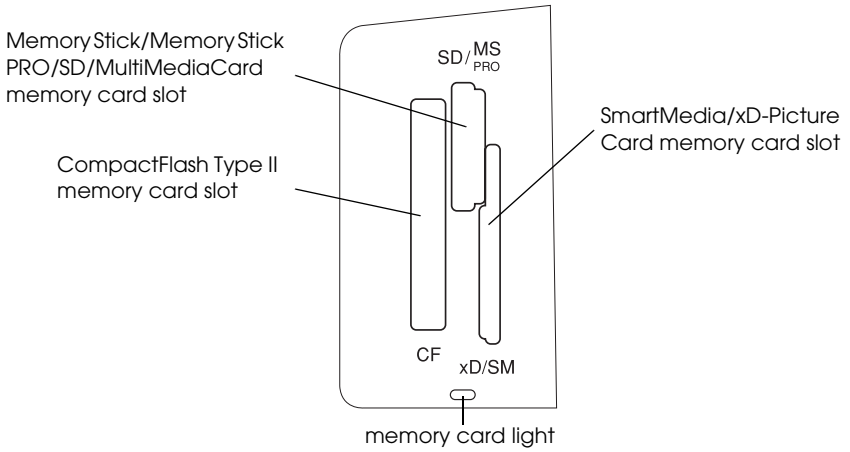

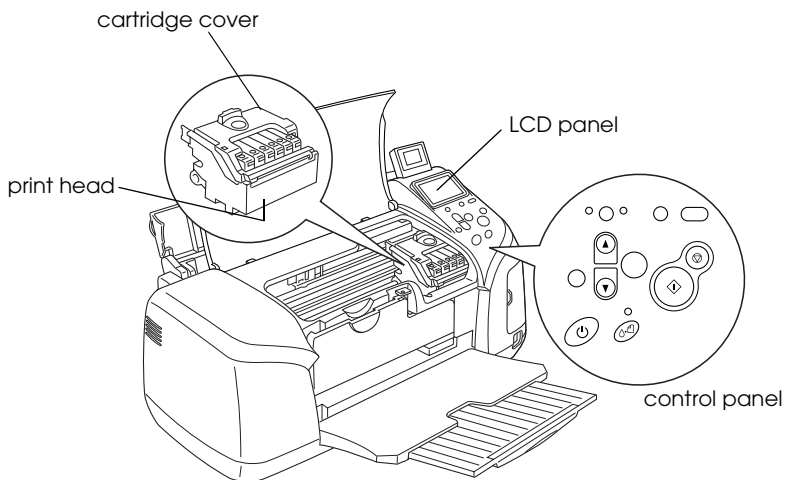

## Control Panel

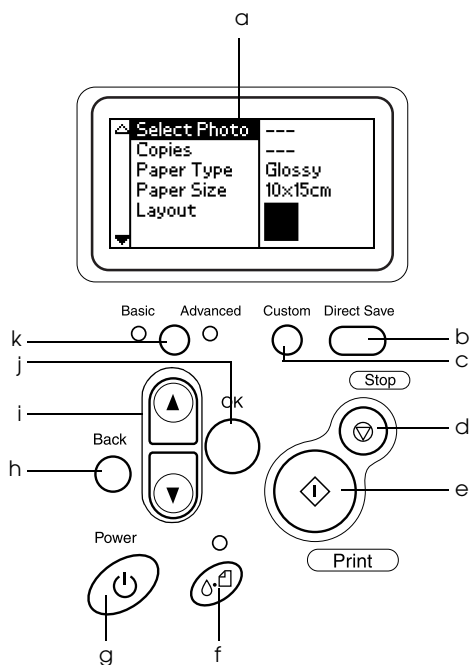





## Buttons

- a. **LCD panel:** Shows the items and settings you change with the buttons on the control panel.
- b. **Direct Save button:** Store the contents of memory card in an external storage device.
- c. **Custom buttons:** Store the current settings on the LCD panel when held down for more than two seconds. Load the stored settings when pressed.
- d. **Stop button:** Cancels print operations, or the settings on the LCD panel.
- e. **Print button:** Starts printing with the settings on the LCD panel selected via the buttons on the control panel.
- f. **Maintenance button:** Refer to the following table for details.
- g. **Power button:** Refer to the following table for details.
- h. **Back button:** Returns to the main menu on the LCD panel.
- i. **Up/Down arrow buttons:** Move the cursor on the LCD panel. Increase and decrease numbers being entered.
- j. **OK button:** Opens the setting menu and selects the item to be set on the LCD panel.
- k. **Basic/Advanced mode switch button:** Switches between Basic mode and Advanced mode.

**Note:**

*With the exception of the maintenance button, the stop button and the power button, the control panel buttons are used only with direct printing from a memory card.*

Button	Function
 power	Turns the printer on and off.
 maintenance	Displays instructions to resolve errors, or cleans the following errors: No ink No ink cartridge/abnormality No paper (cut sheet only) Paper jam Multi-page feed Starts the Ink Cartridge Replacement utility. Displays the Ink Cartridge Replacement menu when the  maintenance light is off and the button is pressed when in Advanced Mode. If the Maintenance button is pressed when in Basic Mode, nothing happens.

## Lights

Light	Description
Maintenance 	On or flashes when an error occurs. On the LCD panel, check the description of the error.
Basic Print mode	On when Basic Print mode is selected.
Advanced Print mode	On when Advanced Print mode is selected.
Memory card	On when a memory card is inserted into the memory card slot. Flashes when the printer is accessing the memory card.



### **Caution:**

*Use only one type of memory card at a time. Eject the loaded memory card before inserting another memory card.*

# Direct Printing Basics

---

## Introduction

This section provides information on how to print directly from a memory card using settings on the LCD panel and without the use of a computer.

**Note:**

- ❑ *Before printing large jobs, print a single sheet to confirm quality.*
- ❑ *Disconnecting the USB cable is recommended when printing directly from a memory card.*

For printing from a computer, double click the ESPR320 Reference Guide icon on the desktop.

---

## Loading Single Sheets of Paper

Follow the steps below to load paper into the printer.

1. Open the paper support, then slide out the extension.
2. Lower the output tray and slide out the extension.
3. Position the left edge guide so that the distance between the two guides is slightly wider than the width of your paper.
4. Fan a stack of plain paper, then tap it on a flat surface to even the edges.

5. Load the paper with the printable side up so it is against the right edge guide, and slide it into the sheet feeder. Then slide the left edge guide against the left edge of the paper. Make sure that the paper stack is loaded under the tabs inside the edge guides.

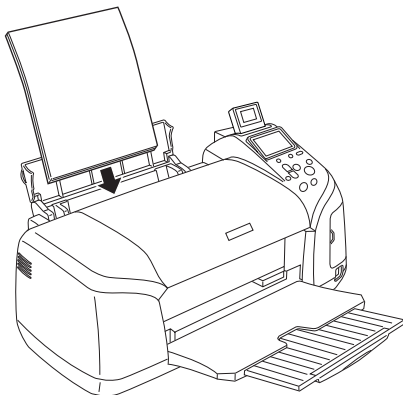

**Note:**

- ❑ *Leave enough space in front of the printer for the paper to be fully ejected.*
- ❑ *Always load paper into the sheet feeder short edge first.*
- ❑ *Make sure that the paper stack is flush with or lower than the triangular load-limit mark on the edge guide.*
- ❑ *Make sure the CD/DVD tray is not inserted in the printer and the CD/DVD guide is up.*

<b>Media Type</b>	<b>Loading Capacity</b>
EPSON Photo Paper	Up to 20 sheets.
EPSON Matte Paper-Heavyweight	Up to 20 sheets.
EPSON Premium Glossy Photo Paper	Up to 20 sheets.

EPSON Premium Semigloss Photo Paper	Up to 20 sheets.
EPSON Photo Stickers	One sheet at a time.
EPSON Iron-On Cool Peel Transfer Paper	One sheet at a time.

---

## ***Loading Memory Cards***

### ***Loadable storage media***

Digital photographs are stored either in the digital camera's built-in memory or in loadable storage media called memory cards. Memory cards can be inserted into and removed from the camera. The types of storage media that can be used with this printer are shown below.

Loadable storage media:

- CompactFlash
- Memory Stick
- Memory Stick Duo\*
- MultiMediaCard
- SmartMedia
- xD-Picture Card
- MagicGate Memory Stick Duo\*
- MagicGate Memory Stick
- Memory Stick PRO
- Microdrive
- SD Card
- miniSD card\*
- Memory Stick PRO Duo\*

\* Adapter required.



**Caution:**

*The methods for using memory cards vary according to card type. Be sure to refer to the documentation packaged with your memory card for details.*

**Note:**

*See “Memory card data format” on page 22 for the specifications of memory cards that can be used with the printer.*

## **Memory card data format**

You can use image files that meet the following requirements.

Digital camera	DCF compliant <sup>*1</sup>
File format	JPEG format image files <sup>*2</sup> taken with a DCF compliant digital camera
Image size	Vertical 120 to 4600 pixels, horizontal 120 to 4600 pixels
Number of files	Up to 999

<sup>\*1</sup>: DCF stands for the “Design rule for Camera File system” standard, set by the Japan Electronics and Information Technology Industries Association (JEITA).

<sup>\*2</sup>: Supports Exif Version 2.1/2.2.

**Note:**

*File names containing double-byte characters are not valid when printing directly from a memory card.*

## Inserting memory cards

Turn the printer on, open the memory card slot cover, then insert a memory card as shown in the illustration. When the memory card is inserted correctly, the memory card light will come on.

CompactFlash/  
Microdrive

Memory Stick/  
Memory Stick PRO/  
MagicGate Memory  
Stick/  
Memory Stick Duo/  
MultiMediaCard/  
SD Card/  
miniSD card/  
Memory Stick PRO Duo/  
MagicGate memory Stick  
Duo

SmartMedia/  
xD-Picture Card

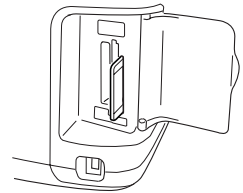
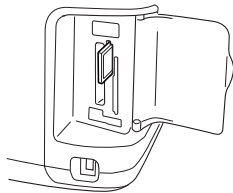
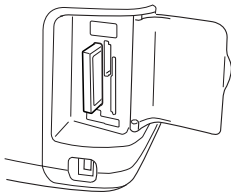
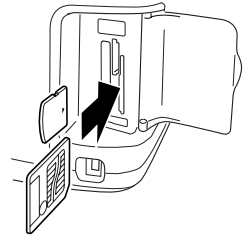
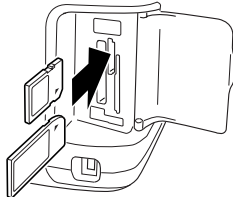
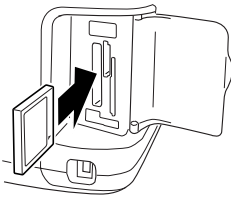



**Caution:**

- ❑ *Insert a memory card so that the top of the card faces the right side, as shown in the illustration.*
- ❑ *Loading a memory card in ways other than those shown here may damage the printer, memory card, or both.*
- ❑ *Use only one type of memory card at a time. Eject the loaded memory card before inserting another kind of memory card.*
- ❑ *Close the memory card slot cover when the memory card is in operation to protect the memory card from static electricity. If you touch the memory card when it is inserted in the printer, it may cause the printer to malfunction.*
- ❑ *Before loading the Memory Stick Duo, Memory Stick PRO Duo, miniSD Card, and MagicGate Memory Stick Duo attach the adapter provided with it.*

---

## **Basic Printing**

This printer has two print modes, Basic and Advanced. Basic mode makes it easy to select photos, print or make copies. Advanced mode enables you to edit various settings. Refer to “Advanced Printing” on page 39.

**Note:**

*When Basic Mode is selected, Paper Type, Paper Size and Layout are automatically set to Premium Glossy Photo Paper, 10 × 15 cm and Borderless or index.*



## Printing an index

You can print one or more copies of an index of all the photographs on a loaded memory card. An index can be helpful in selecting which photos you want to print.

1. Make sure that Basic Mode is selected.



**Note:**

When Advanced Mode is selected, press the Basic/Advanced mode switch button, then press the OK button to switch to Basic Mode.

2. Make sure Select Photo is highlighted, then press the OK button to open the menu.
3. Press the ▲ button to select Index, then press the OK button.



4. Make sure that 1 each is indicated as the Copies setting.



5. Press the Print button to print the index.

## ***Single photo print***

The example here is to print a single photo on the 10 × 15 cm size of Premium Glossy Photo Paper with Borderless and normal print quality.

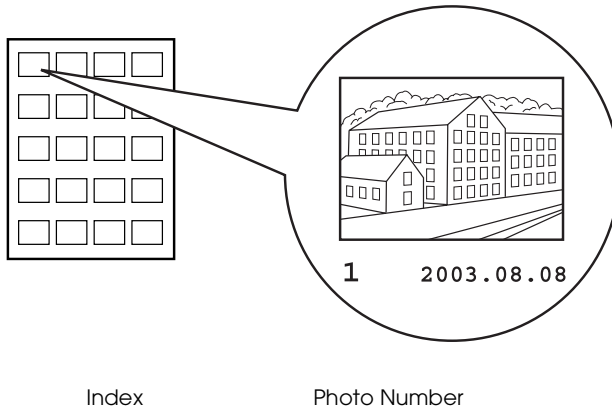

1. If you have printed an index, find the number of photo that you want to print from the index. The number is printed under the photo. If not, proceed to Step 2.
2. Press the ▲ or ▼ button to select Select Photo then press the OK button.

- Press the ▲ or ▼ button to specify the photo number that you have selected from the Index, then press the OK button.

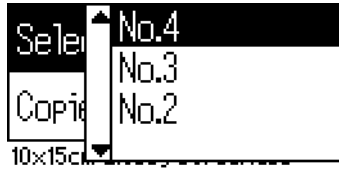

- Select Copies, press the OK button to open the Copies counter, select the number you want to print, then press the OK button.



- Press the Print button to start printing.

## ***Print all photographs on the memory card***

All: Print all photographs on the memory card.

- Select All as the Select Photo, then press the OK button.



### ***Note:***

*The first image is displayed on the preview monitor.*

2. Select Copies, press the OK button to open the Copies counter, select the number you want to print, then press the OK button.
3. Press the Print button to start printing.

## ***Print multiple selected photographs***

Individual: Print selected photographs from the memory card.

1. Select Individual as the Select Photo, then press the OK button.
2. Press the ▲ or ▼ button to select the photo number you want to print, then press the OK button. The selected number is displayed on the preview monitor.

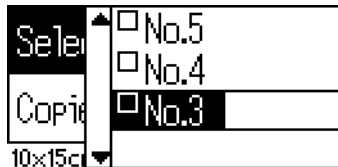

3. Press the ▲ or ▼ button to select the number of copies you want to print, then press OK button. You can select up to 10 copies.



4. Repeat steps 2 through 3 to register other photos.

**Note:**

To reset the number of copies, select the photo and press the OK button. The number of copies resets to 0 and the check box becomes unchecked.

5. When you have finished selecting photos, press the Back button, then press the OK button to confirm your selections.

No.8	3 each
No.5	5 each
No.3	2 each
Press Back to go back.	

6. When the numbers of all the photos you want to print have been registered, press the Print button to print the selected photographs.

## ***Print the DPOF data***

This printer conforms to DPOF (Digital Print Order Format) version 1.10. DPOF lets you set the photo numbers and the number of copies for photos on the digital camera before you print. To create DPOF data that supports DPOF, you must use a digital camera that supports DPOF. For the details about DPOF settings, see your digital camera's documentation.

1. Load a memory card which contains DPOF data. Once a memory card has been loaded, the Select Photo value becomes DPOF and the Copies value becomes the number of copies you selected on your digital camera.

Select Photo	DPOF
Copies	7 total

10×15cm Glossy borderless

2. Press the Print button to start printing.

## ***Print a range of photographs***

Range: Print a range of selected photographs from the memory card.

1. Select Range as the select Photo, then press the OK button.
2. Press the ▲ or ▼ button to select the number of the first photo you want to print From:, then press the OK button. Next, select the number of the last photo you want to print To:, then press the OK button.

From: 4	OK
To: 15	OK

3. Select the number of Copies, and press the Print button to print the selected photographs.

## Print P.I.F. Index

Using P.I.F. Index is possible to print a list of the PRINT Image Framer frames stored in the memory card, when the memory card is in the printer.

1. Select P.I.F. Index from Select Photo, then press the OK button.
2. Make sure that 1 each is selected as the Copies setting.
3. Press the Print button to start printing.

---

## Printing on CD/DVD

This section provides information on how to use the LCD panel to print directly onto a CD/DVD, without the use of a computer. It provides step-by-step instructions on how to load the CD/DVD in the printer, how to select the print layout, and how to adjust the print settings.

Refer to the *Reference Guide* on the desktop if you are printing from a computer connected to the printer.

When printing on CD/DVD, keep the following points in mind:

**Note:**

- ❑ *Use only CD/DVD media labelled as suitable for printing, for example "Printable on the label surface" or "Printable with ink jet printers".*
- ❑ *The printed surface is easily smeared immediately after printing.*
- ❑ *Be sure to let CDs and DVDs dry completely before using them or touching the printed surface.*
- ❑ *Do not allow the printed CD/DVD to dry in direct sunlight.*

- ❑ *Moisture on the printable surface may cause smearing.*
- ❑ *If the CD/DVD tray or the internal transparent compartment are accidentally printed on, immediately wipe off the ink.*
- ❑ *Reprinting on the same CD/DVD may not improve the print quality.*

## **Preparing to Print on CD/DVD**

1. Open the printer cover, then open the CD/DVD guide.
2. The “Switching to CD/DVD print mode” message appears when you open the CD/DVD guide, and the print settings are automatically set to those for printing onto CD/DVDs.

**Note:**

*An error occurs if the CD/DVD guide is opened while printing, or if paper is loaded in the sheet feeder.*

3. Insert the memory card containing the photo data you want to print into the memory card slot.

## **Selecting the Layout**

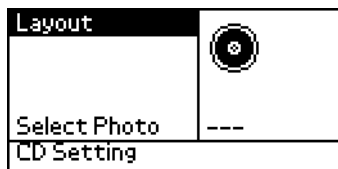

1. Make sure that Layout is selected in the LCD panel settings, then press the OK button.



2. Press the ▼ button to select the desired layout, then press the OK button.



You can select the following layout options when printing on a CD/DVD.

	One photo will be printed on the CD/DVD, centered on the hole in the middle of the disc.
	Four photos will be printed on the CD/DVD, with one image in each of four quarters.
	12 photos will be printed on the CD/DVD, arranged in a circle around the outer edge of the disc.

## Selecting the Photos to Print

1. Press the ▼ button to highlight Select Photo, then press the OK button.
2. Press the ▼ button to select the desired photo, checking with the preview monitor, then press the OK button.



**Note:**

*This screen appears when 4-photo or 12-photo has been selected in the Layout settings.*

3. Press the ▲ button to specify the number of prints for each photo, if you selected the 4-photo or 12-photo option for the Layout setting.



**Note:**

- ❑ To select more than one photo, repeat steps 2 and 3 to select other photos and the number of times to print them.
- ❑ The total number of images that will be printed is displayed at the bottom of the LCD display.
- ❑ When selecting photos for the 4-photo or 12-photo layout setting, you can select a number of images less than the total. Unused areas of the layout will be left blank. If you specify a number of images greater than will fit on one CD/DVD, the extra images will be added to a layout for an extra CD/DVD and the printer will ask you to load another CD/DVD after printing the CD/DVD.

## **Loading a CD/DVD**

1. Place the CD/DVD on the CD/DVD tray with the label surface up.

2. Insert the CD/DVD tray into the CD/DVD guide.

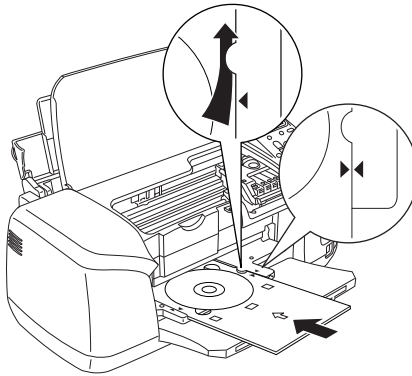

**Note:**

- ❑ *Align the arrow mark on the CD/DVD tray with the arrow mark on the CD/DVD guide.*
  - ❑ *Insert the CD/DVD tray so that the CD/DVD tray passes under the small rollers on the both sides of the CD/DVD slot.*
3. Close the printer cover.
  4. Press the **BACK** button to return to the Layout screen. The selected image is displayed on the preview monitor. Then, press the **Print** button to print the CD/DVD.

**Note:**

- ❑ *We recommend that you print a test of the layout on a test CD/DVD, before printing on a real CD/DVD.*
- ❑ *If necessary, you can adjust the print position. See “Adjusting the Print Position” on page 36 for details.*
- ❑ *If an error message appears on the LCD panel, follow the instructions on the LCD panel to clear the error.*

## Adjusting the Print Position

Follow the steps below to adjust the print position, if necessary.

1. Press the ▲ or ▼ button to highlight CD Setting and press the OK button.
2. To move the image up or down; press the ▲ button to select CD/DVD Print Position Adjustment Up/Down and press the OK button.

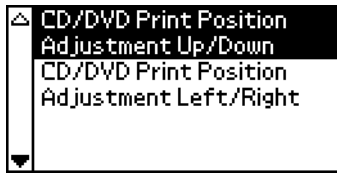

3. Press the ▲ or ▼ button to select the direction and amount to move the image, then press the OK button.



4. To move the image left or right; press the ▼ button to select CD/DVD Print Position Adjustment Left/Right and press the OK button.

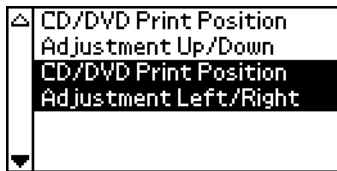

5. Press the ▲ or ▼ button to select the direction and amount to move the image, then press the OK button.

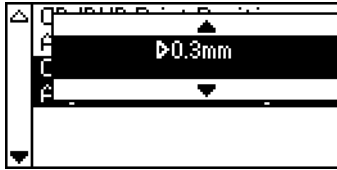

6. Press the BACK button to return to the Layout screen, then press the Print button to print the CD/DVD.

**Note:**

*The printer remembers the print adjustment setting even after it has been turned off, so you do not need to adjust the position each time you use the CD/DVD function.*

## ***Adjusting the Print Density***

Follow the steps below to adjust the amount of ink used when printing photos on a CD/DVD. This adjusts the depth of color in the printed image.

1. Press the ▲ or ▼ button to highlight CD Setting and press the OK button.
2. Select Color Density and press the OK button.
3. Press the ▼ button to select the desired color density and press the OK button.

---

## Canceling Printing Using the Control Panel

To stop printing in progress, press the Stop button. The printer will cancel all print jobs, stop printing, and eject any pages or CD/DVD tray that were printing. Depending on the printer's status, printing may not stop immediately.

---

## Ejecting Memory Cards

After printing all of the jobs, eject the memory card.

1. Make sure that the memory card light is not flashing.
2. Open the memory card slot cover then pull the card out to eject the memory card.



**Caution:**

- ❑ *The handling method varies depending on the storage media. Be sure to refer to the documentation packaged with your memory card for details.*
- ❑ *Do not remove memory cards or turn off power to the printer while printing or while the memory card light is flashing. Doing so can cause data to be lost.*

# Various Setting

## Advanced Printing

### Main settings



**Note:**

Press the Basic/Advanced mode button to select Advanced Mode if Basic Mode is selected.

a. Select Photo

On this menu, you can select how to print data stored on a memory card.

All	Print all photographs on the memory card.
Index	Print an index of all photographs on the memory card.
Range	Print a range of Photographs on the memory card.
DPOF	This option is automatically displayed when a memory card contains data whose printing instruction is set with a DPOF-compatible digital camera. Even if DPOF is selected, DPOF does not work when a memory card does not contain data set by DPOF.

P.I.F. Index	Print an index of the PRINT Image Framer frames stored in the memory card.
Photo number	Print a single, selected photograph from the memory card.
Individual	Print selected photographs from the memory card.

### b. Copies

Select the number of copies you want to print.

### c. Paper Type

On this menu, the paper type can be selected.

Glossy	Print on EPSON Premium Glossy Photo Paper or EPSON Premium Semigloss Photo Paper.
Photo	Print on EPSON Photo Paper.
Matte	Print on EPSON Matte Paper Heavyweight.
Plain	Print on plain paper, EPSON Premium Ink Jet Plain Paper, or EPSON Bright White Ink Jet Paper.
Stickers	Print on EPSON Photo Stickers.
Iron-on	Print on EPSON Iron-On Cool Peel Transfer Paper.

### d. Paper Size











On this menu, the paper size can be selected. The print size is automatically scaled up/down depending on the combination of selected paper size and layout.

10 × 15 cm	Print on 10 × 15 cm (4 × 6 in) size sheets of paper.
13 × 18 cm	Print on 13 × 18 cm (5 × 7 in) size sheets of paper.
A4	Print on A4 size (210 × 297 mm) sheets of paper.
A6	Print on A6 size (105 × 148 mm) sheets of paper.



## e. Layout

On this menu, the print layout can be specified.

	Borderless	Prints without margins. Portrait layout.
	Single	Prints with 3-mm margins on all sides. Portrait layout.
	Upper half	Prints in the upper half without a border.
	Double	Prints two images (landscape) on one page.
	Quarter	Prints four images (portrait) on one page.
	Octet	Prints eight images (landscape) on one page.
	20	Prints 20 images (landscape) on one page.
	Index	Print 80 images (landscape) on one page.
	Jewel Case	Prints to the size of a CD case without a border and with perforation lines.
	Jewel Case-Index	Prints 12 pictures on both sides of the paper to the size of CD case with perforation lines.

When Borderless printing, note the following:

- Printing without margins takes longer than printing with margins.

- ❑ Because this setting enlarges the image to a size slightly larger than the paper size, the portion of the image that extends beyond the edges of the paper will not be printed.
- ❑ Print quality may decline in the top and bottom areas of the printout, or the area may be smeared when printing.
- ❑ Before printing large jobs, print a single sheet to confirm quality.

---

## ***More Options***

### ***Photo Number***

When All, Range or Individual is selected as the Select Photo, this setting allows you to specify the number of the photo that you want to enhance or correct using the More Options. The default setting here is All, which means the settings will affect all of the photos to print.

### ***Zoom***

This setting allows you to zoom in on a specific point in a photo and print out the image. The printed region of the image is trimmed to the size of the original photo.

The base point can be selected from nine options: Upper Left, Center Left, Lower Left, Upper Center, Center, Lower Center, Upper Right, Center Right, and Lower Right. You can select either 1.2 or 1.5 times magnification. The preview monitor shows the trimmed area with a yellow frame.

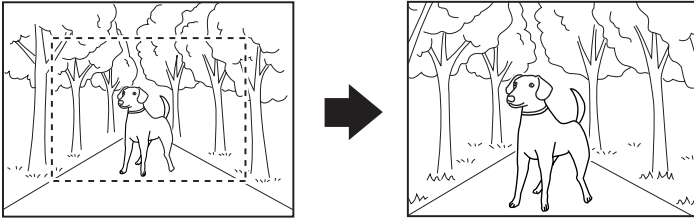

Example. Center 1.5x

**Note:**

*When the photo is zoomed, the image may become blurry depending on the resolution of the original photo.*

## Filter

This setting can be used to adjust the color tones used for printouts, by applying a filter before the photos are printed. The default setting is None.

None	No filter is applied to the printouts.
B&W	Photos are printed in grayscale, similar to a black and white photo.
Sepia	Photos are printed with a sepia tint, similar to the brown tint seen in old photographs.

## Automatic Correction

This printer is able to correct the color of printouts automatically. There are two kinds of correction available. By default, the setting is P.I.M.

For printing with PRINT Image Matching, see “Exif Print and PRINT Image Matching” on page 50.

P.I.M. (PRINT Image Matching)	Print with the PRINT Image Matching function. If the photo data does not include PRINT Image Matching data, try printing with PhotoEnhance.
PhotoEnhance	Images imported from the memory card are automatically enhanced. Printing requires more time, but the image is enhanced to ensure higher picture quality.
Exif	ExifPrint function. If the Photo data does not include ExifPrint data, try printing with PhotoEnhance.
None	Print without automatic correction.

## Small Image Enhancer

This option can remove digital noise, or interference, from photos and increase the resolution for small images, so that they can be printed at larger sizes.

**Note:**

*Images may take longer to print when this option is enabled.*

## Contrast

This setting can be used to adjust the contrast for printouts, which makes light areas of the image appear lighter and dark areas darker.

## ***Brightness***

This setting allows you to adjust the brightness of your printouts. The default setting is Standard.

## ***Saturation***

This setting allows you to adjust the vividness of your printouts. The default setting is Standard.

## ***Sharpness***

This setting allows you to adjust the sharpness of your printouts. The default setting is Standard.

## ***Date***

This setting is to print the date information contained in your photo data. The default setting is None.

The following examples show the format options for setting the date.

None	Does not print the date.
mmm.dd.yyyy	Dec.31.2002
dd.mmm.yyyy	31.Dec.2002
yyyy.mm.dd	2002.12.31

## ***Time***

This setting is to print the time information contained in your photo data. The default setting is None.

The following examples show the format options for setting the time.

None	Does not print the time.
12-hour system	10:00
24-hour system	22:00

## ***Photo Information***

If your photo data contains the photo information conforms to Exif standard, the information can be printed with this setting. Following information will be printed:

Exposure time/Shutter speed (Exposure time takes precedence if both values exist. ex. 1/30s)

F number (ex. F2.8)

ISO speed rate (ex. ISO100)

The default setting is Off.

On	Prints photo information: Exposure time/Shutter speed/
Off	Does not print any photo information.

## Fit to Frame

This setting automatically trims the parts of an image that extend beyond the margins of the selected print size. Either the top and bottom areas or the left and right areas of the image will be trimmed, depending on the aspect ratio of the original photo and the selected print size. The default setting is On.

On	Trims the image.
Off	Does not trim the image

Resize each photo (without trimming it) so that it fits inside the print area specified on the Layout menu. Margins may appear at the left and right of the photo, depending on the print size and aspect ratio.

## Quality

This setting allows you to adjust the quality of your printouts. The default setting is High.

## Bidirectional Printing

This setting activates bidirectional printing so your printer prints both left-to-right and right-to-left. Bidirectional printing speeds up printing, but decreases print quality. By default, this setting is On.

**Note:**

*If misaligned, vertical lines appear during bidirectional printing, you may need to align the print head. To align the print head, see “Aligning the Print Head” on page 73.*

## ***Sticker Adjustment: Up/Down***

This setting allows you to adjust the print position of the Photo Stickers by moving the image up or down.

## ***Sticker Adjustment: Left/Right***

This setting allows you to adjust the print position of the Photo Stickers by moving the image to the left or right.

## ***Ink Cartridge Replacement***

The ink cartridge can be replaced by selecting this option.

➔ See “Replacing an Ink Cartridge” on page 64

## ***Head Cleaning***

The print head can be cleaned by selecting this option.

➔ See “Cleaning the Print Head” on page 71

## ***Nozzle Check***

A nozzle check pattern can be printed by selecting this option.

➔ See “Checking the Print Head Nozzles” on page 70

## ***Paper Feed/Paper Eject***

Press the OK button in this menu, then press the OK button again to confirm. The Paper Feed/Paper Eject function is performed.



## ***Print Head Alignment***

The print head can be aligned by selecting this option.

➔ See “Aligning the Print Head” on page 73

## ***Color LCD Contrast***

The contrast of the preview monitor can be adjusted by selecting this option.

## ***LCD Contrast***

The contrast of the LCD panel can be adjusted by selecting this option.

## ***Memory Card Overwrite***

This option sets whether or not writing from a computer to a memory card is allowed when the printer is connected to the computer. By default, the setting is Enable.

Enable	Writing to the card from computer is allowed. Writing, deleting, formatting, and creation of files/directories are possible.
Disable	Writing to the card from computer is prohibited. Writing, deleting, formatting, and creation of files/directories are not possible.

## ***Platen Gap***

Adjusts the size of the gap between the platen and the print head. Select Wide if your printouts are rubbed while printing.

## ***Restore Factory Settings***

This resets all the settings to default. If you use this function, the setting values for each mode will be reset to the values which were preset at the factory.

## ***Language***

The language displayed on the LCD panel can be selected with this option.

## ***BT Device Name Setting***

### ***BT Communication mode***

### ***BT Encryption***

### ***BT Passkey Setting***

### ***BT Device Address***

These settings are available when the optional Bluetooth Photo Print Adapter is connected to the printer.

For more details, refer to the "Using the Bluetooth Photo Printer Adapter" in the *Online Reference Guide*.

---

## ***Exif Print and PRINT Image Matching***

Exif Version 2.2 (also called Exif Print, an international standard for digital cameras) and PRINT Image Matching allow you to print fine-quality photographs using, in combination, a digital camera and printer that support these features.

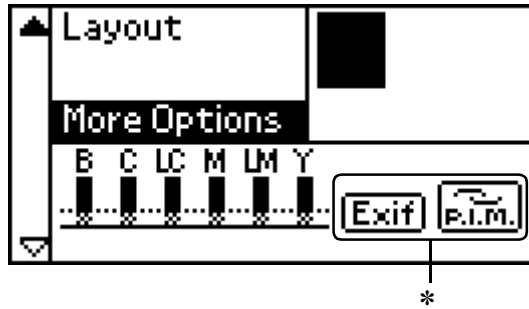

- \* The Exif and P.I.M. icons appears when the first photograph in the memory card has PRINT Image Matching or Exif Print information and when All, Range, Photo number and Individual selected in Select Photo.

## ***Effectiveness***

### ***Exif Print***

When taking photographs using an Exif Print compatible digital camera, information about camera settings and scene conditions when the photograph was taken is embedded in the photo data. Such information includes exposure mode, white balance, gain control, contrast, saturation, and sharpness, among other attributes. The printer then corrects and enhances the photo data using this information and prints an image that reflects the original scene captured by the digital camera.

## ***PRINT Image Matching***

PRINT Image Matching gives control of the printing process to the digital camera, allowing printed images to reflect the camera's distinctive qualities. When taking photographs using a PRINT Image Matching compatible digital camera, print command information from the camera is embedded in the photo data. The print command then instructs the printer how to correct color and details based on information stored at the moment the photo was taken. Digital camera settings that create the print command include the gamma, color space, color balance, shadow point, contrast, and brightness settings, among other attributes. A printer equipped with PRINT Image Matching is able to interpret these commands and faithfully reproduce the characteristics of the image captured by the digital camera.

### ***Note:***

- ❑ *See the relevant device instruction manual for details concerning the use of devices loaded with the PRINT Image Matching function.*
- ❑ *Please check with the input device manufacturer to determine whether it is loaded with the PRINT Image Matching function.*

## ***Printing without a PC***

Insert the digital camera memory card into the memory card slot, specify the image to be printed to retrieve print commands registered in the image file and print.

Exif Print and PRINT Image Matching are compatible with the media listed below.

Select from these media types when printing.

Plain Paper/EPSON Premium Ink Jet Plain Paper/  
EPSON Bright White Ink Jet Paper/EPSON Photo Paper/  
EPSON Matte Paper-Heavyweight/  
EPSON Premium Glossy Photo Paper/  
EPSON Premium Semigloss Photo Paper/  
EPSON Photo Stickers

**Note:**

*Refer to the digital camera's documentation to find out whether the camera is Exif Print and/or PRINT Image Matching compatible.*

---

## **DPOF Settings**

This printer conforms to DPOF (Digital Print Order Format) version 1.10. DPOF lets you set the photo numbers and the number of copies for photos on the digital camera before you print. To create DPOF compliant data, you must use a digital camera that supports DPOF. For the details about DPOF settings, see your digital camera's documentation.

1. Load paper and a memory card which contains DPOF data. Select Photo turns into DPOF as soon as you load the memory card. To exit DPOF mode, select the other settings as the Select Photo.
2. Make Paper Type, Paper Size, and Layout settings. The copies menu shows the number of sheets of paper required for the selected layout.

**Note:**

*Layout setting is not available when the DPOF settings are for an Index print.*

3. Press the Print button to start printing.

---

## ***PRINT Image Framer***

1. Insert the memory card containing digital photo data and PRINT Image Framer data into the printer's card slot. If you have saved or deleted data on the memory card via your computer and have not ejected the memory card from the printer since, eject and reinsert the memory card before printing.

***Note:***

*Be sure to save the PRINT Image Framer data to the memory card using the EPSON PRINT Image Framer Tool; otherwise the P.I.F. file name will not appear on the LCD panel.*

2. Select All, Range, Photo number or Individual from the Select Photo menu. Index cannot be used with PRINT Image Framer data.
3. Select the type of paper loaded in the printer from the Paper Type menu.
4. Select the size of paper loaded in the printer from the Paper Size menu. Be sure the size of paper loaded matches that specified for the PRINT Image Framer data. The paper sizes available in the Paper Size menu change according to the Paper Type selected, therefore with certain types of paper the size appropriate for the PRINT Image Framer data may not be listed.

- Select the desired PRINT Image Framer data from the Layout menu. The PRINT Image Framer data file is displayed. PRINT Image Framer data is located at the bottom of the Layout menu.

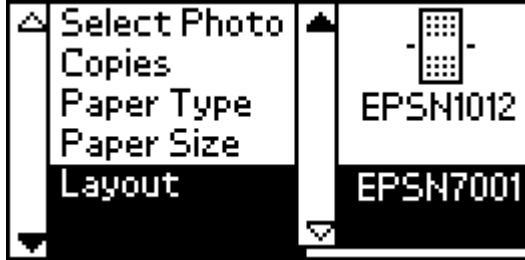

**Note:**

*You can view PRINT Image Framer layout images on the preview monitor, but you cannot view photos images at this time.*

- Specify the photos that you want to print and the number of copies of each using the Select Photo and Copies menus.
- Press the Print button to start printing.

---

## **Digital Camera Direct Printing**

You can use this feature with digital cameras which support the USB DIRECT-PRINT or PictBridge functions. For more details on the operation of the digital camera, refer to its manual.

1. Turn on the printer and load the paper.
2. Make sure that no memory card is loaded.
3. Use the printer's control panel to adjust the print settings. (e.g. paper size, paper type, and layout)
4. Turn on the digital camera, then connect the printer and the digital camera with a USB cable.

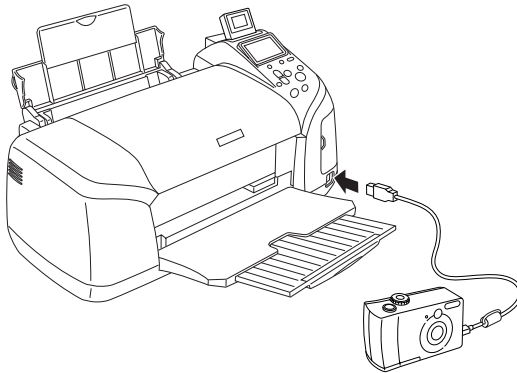

5. Use the digital camera to select the photo you want to print. Be sure to make the desired print settings on the digital camera because the digital camera settings generally take precedence over the printer settings.
6. Print from the digital camera.



**Note:**

- ❑ *Do not backup before or while a digital camera is connected to the printer.*
- ❑ *Your printer has two USB connectors, one on the front and one on the rear. Although you can connect a USB cable to either, Epson recommends that you use the front USB connector for connecting the digital camera and the rear USB connector for connecting a portable computer or a desktop computer.*
- ❑ *Some of the settings on your digital camera may not be reflected in the output because of the printer's specifications.*
- ❑ *Depending on the type of digital camera, images containing DPOF information may not be available for CD/DVD printing.*

---

## **Storing and Loading the Settings**

You can store the settings on the LCD panel you use frequently to each of Custom buttons and load the stored settings easily by pressing the Custom buttons.

You can store the following settings:

- ❑ Select Photo\*
- ❑ Paper Type
- ❑ Paper Size
- ❑ Layout
- ❑ Filter in More Options
- ❑ Small Image Enhancer in More Options
- ❑ Brightness in More Options

- ❑ Saturation in More Options
- ❑ Sharpness in More Options
- ❑ Contrast in More Options
- ❑ Automatic Correction in More Options

\* The DPOF and P.I.F. Index settings are not available.

**Note:**

- ❑ *This function is not available in Basic Mode.*
- ❑ *You cannot store or load the settings or restore stored settings when an error occurs, when printing the nozzle check pattern or cleaning the print head or replacing the ink cartridge and aligning the print head.*
- ❑ *You can store the settings for Filter, Brightness, Saturation, Contrast and Sharpness when All is set as Photo Number in More Options.*

Follow the steps below to store the settings on the LCD panel to the Custom buttons.

1. Make the settings that you want to use.
2. Press the Custom button for more than two seconds. The message "The present settings have been saved" is displayed in the LCD panel.

To you restore stored settings, press the Custom button for more than two seconds.

The message "Custom settings will be used." is displayed in the LCD panel.

---

## Backup

Press the Direct Save button, it is possible to store the contents of a memory card in an external storage device, such as an MO (magneto-optical) drive, Zip<sup>®</sup> drive, CD-R/RW drive, or USB Flash Drive by connecting it to the printer.

**Note:**

- The media must have enough free space for backup.*
- The media must have only one partition.*
- You cannot back up while printing from the computer to the printer.*
- Do not connect the external storage device while the computer is accessing the memory card in the printer.*
- The message "Cannot recognize the loaded media." is displayed on the LCD panel if the storage media is not formatted for DOS or Windows. Follow the instructions on the LCD panel to format the storage media.*
- You can backup up to 512 times to one storage medium, with the exception of CD-R.*
- The media except CD-R must be formatted for DOS or Windows.*
- The format for writing to CD-R is Multisession (Mode 1) and the file system is ISO 9660. Due to the ISO 9660 file system, the contents of a memory card that has 8 or more folder levels cannot be backed up to CD-R.*
- The characters that can be used for folder and file names on the CD-R are capitals and the underscore (\_). Other characters are changed to underscores when backing up to CD-R.*
- One session is created with each backup when backing up to CD-R.*
- You can backup up to 47 times in a 640 MB CD-R or 50 times in a 700 MB CD-R.*

Connect the external storage device to the printer and operate according to the instructions displayed on the LCD panel. To learn more about connecting an external storage device, see “Connecting an external device” on page 60.



**Caution:**

*Do not remove the storage media from the external storage device or disconnect the cable from the printer while backing up.*

---

## **Printing with an External Device**

You can connect the printer with an external device such as an MO (magneto-optical) drive, Zip drive, CD-R/RW drive, or USB Flash Drive, and print data directly from these devices.

### **Connecting an external device**



**Caution:**

- Not all of the devices that can be connected with USB cable are supported. Contact your regional customer support for details.*
  
- Do not connect USB devices other than an external storage device, such as a printer or mouse. The printer may fail.*
  
- Do not connect the external storage device while the computer is accessing the memory card inserted in the printer.*

**Note:**

- A USB cable is necessary in order to connect the printer with the external storage device.*
  
- Use a USB cable of 2 meters or less.*
  
- A USB hub cannot be used.*

- ❑ *Even if the printer is connected to a computer, the computer cannot recognize the external storage device.*

Insert the USB cable to the external device USB connector and insert the other connector into the external storage device.

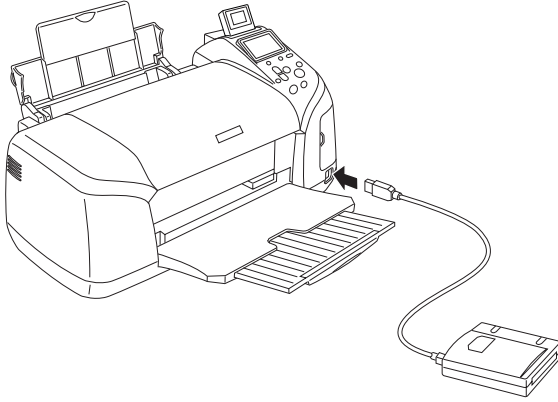

## ***Printing from an external device***

1. Insert a medium that contains photo data into the external storage device.
2. If a memory card has been inserted in the memory card slot, remove it.

### ***Note:***

- ❑ *If a memory card is inserted in the memory card slot, the printer does not recognize the external storage device; it prints out the photo data in the memory card.*
  - ❑ *Select the folder in which the photo data you want to print out is registered using the Folder Selection menu if data in the external storage device has been backed up using the backup function of the printer. The Folder Selection menu is displayed when data in the external storage device is recognized and pressing the BACK button.*
3. Set the individual items using the same procedure as when printing from a memory card, and perform printing.

# Replacing Ink Cartridges

## Checking the Ink Supply

### Using the LCD panel

To check which cartridge requires replacing, check the LCD panel. Press the ▲ or ▼ buttons in Advanced mode to scroll the screen until More Options appears. The ink icons appear beneath More Options on the LCD panel.

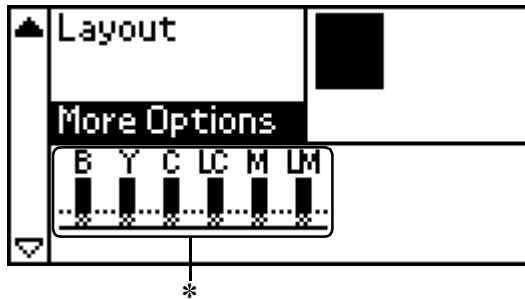

\* ink icon

Ink icon indicates the amount of the ink remaining as follows:

Ink icon	Status
comes on	Ink remaining
and  blinks	Ink cartridge is nearly empty.
blinks	Ink cartridge is empty. Replace with a new one.

---

## Replacing an Ink Cartridge

This printer uses ink cartridges equipped with IC chips. The IC chip accurately monitors the amount of ink used by each cartridge, so even if a cartridge is removed and later reinserted, all of its ink can be used. However, some ink is consumed each time the cartridge is inserted because the printer automatically checks reliability.

You can replace an ink cartridge using the printer's control panel. Refer to the appropriate section below for instructions.



### **Warning:**

- Keep ink cartridges out of the reach of children. Do not allow children to drink from or otherwise handle the cartridges.*
  
- Be careful when you handle the used ink cartridges, as there may be some ink around the ink supply port. If ink gets on your skin, wash the area thoroughly with soap and water. If ink gets into your eyes, flush them immediately with water. If discomfort or vision problems remain after a thorough flushing, see a doctor immediately.*



### **Caution:**

- Epson recommends the use of genuine Epson ink cartridges. Epson warranties do not cover damage to your printer caused by the use of ink cartridges not manufactured by Epson.*
  
- Leave the old cartridge installed in the printer until you have obtained a replacement; otherwise, ink remaining in the print head nozzles may dry out.*
  
- Do not refill the ink cartridges. The printer calculates the amount of ink remaining using an IC chip on the ink cartridge. Even if the cartridge is refilled, the amount of ink remaining will not be recalculated by the IC chip and the amount of ink available for use will not change.*



**Note:**

- ❑ *You cannot continue printing with one ink cartridge empty, even if the other cartridges still contains ink. Before printing, replace the empty cartridge.*
- ❑ *In addition to the ink used during document printing, ink is consumed during the print head cleaning operation, during the self-cleaning cycle which is performed when the printer is turned on, and during ink charging when the ink cartridge is installed in the printer.*
- ❑ *You can check which cartridge needs replacing with the LCD panel. See “Using the LCD panel” on page 63 for detail.*

For more information about ink cartridges.

➔ See “When handling the ink cartridges” on page 11

## ***Using the printer's control panel buttons***

1. Make sure that the printer is on but not printing, then open the paper support, the printer cover, and lower the output tray.

**Note:**

- ❑ *Make sure the CD/DVD tray is not inserted in the printer before you replace the ink cartridge.*
  - ❑ *To check the ink Levels, press the ▼ button in Advanced Mode to scroll to the next screen. The ink icon displayed in the LCD panel flashes when the ink runs low. When the ink runs out, the entire ink icon flashes and a message is displayed.*
2. Check that the message “ink out” is displayed in the LCD panel and press the maintenance button. This message is not displayed if there is some ink left. In this case, press the maintenance button, make sure Ink Cartridge Replacement is selected, and press the OK button. To find out which cartridge requires replacing, see “Checking the Ink Supply” on page 63.

3. Follow the instructions on the screen and press the OK button. The ink cartridge moves slowly to the ink replacement position.

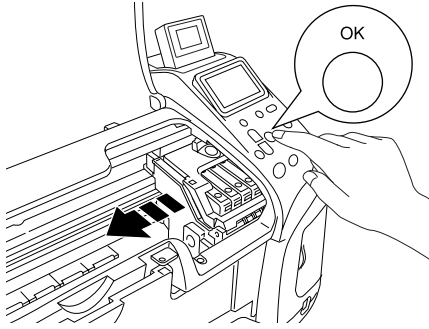

**Caution:**

*Do not move the print head by hand, as this may damage the printer. Always press the OK button to move it.*

4. Remove the new ink cartridge from the package.

**Caution:**

- ❑ *Be careful not to break the hooks on the side of the ink cartridge when you remove it from the package.*
- ❑ *Do not remove or tear the label on the cartridge; otherwise, ink will leak.*
- ❑ *Do not touch the green IC chip on the front of the cartridge. This can damage the ink cartridge.*

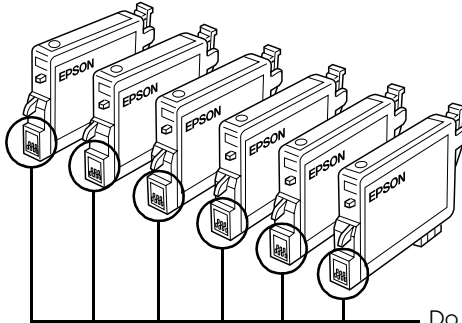

Do not touch this part.

- ❑ *If you remove an ink cartridge for later use, be sure to protect the ink supply area from dirt and dust; store it in the same environment as the printer. Be sure to store the cartridge as shown in the illustration. Note that there is a valve in the ink supply port, making covers or plugs unnecessary, but care is needed to prevent the ink from staining items that the cartridge touches. Do not touch the ink supply port or surrounding area.*
- ❑ *Be sure to always install an ink cartridge into the printer immediately following the removal of the current ink cartridge. If the ink cartridge is not installed promptly, the print head may dry out, rendering it unable to print.*

5. Open the cartridge cover. Pinch the sides of the ink cartridge that you want to replace. Lift the cartridge out of the printer and dispose of it properly. Do not take the used cartridge apart or try to refill it.

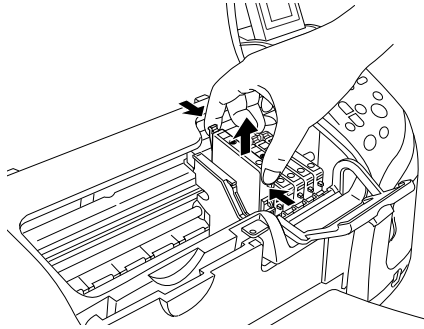

The illustration shows replacement of the black ink cartridge.



**Warning:**

*If ink gets on your hands, wash them thoroughly with soap and water. If ink gets into your eyes, flush them immediately with water. If discomfort or vision problems continue after a thorough flushing, see a doctor immediately.*

6. Place the ink cartridge vertically into the cartridge holder. Then, push the ink cartridge down until it clicks into place.

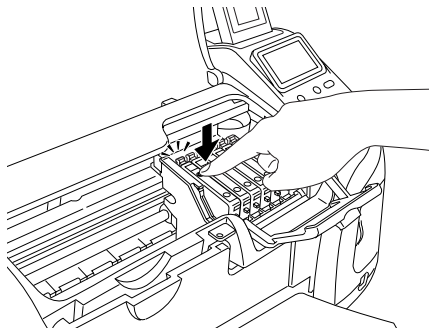

7. When you are finished replacing the cartridge, close the cartridge cover and the printer cover.

8. Press the OK button. The print head will move and begins charging the ink delivery system. When the ink charging process is finished, the print head will return to its home position.

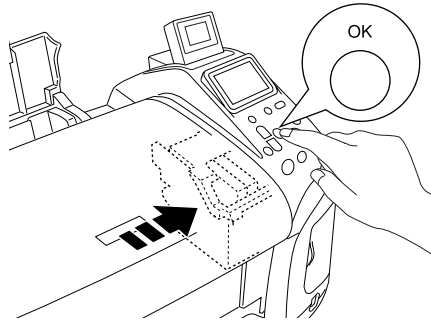

**Caution:**

*The progress meter is displayed in the LCD panel while the ink is being charged. Never turn the power supply to the printer off before the completion message is displayed. Doing so can result in incomplete charging of ink.*

9. When the message “Ink cartridge replacement is complete” is displayed in the LCD panel, press the OK button.

**Note:**

*If the ink end error occurs after the print head moves to its home position, the ink cartridge may not be installed properly. Press the  maintenance button again, and reinstall the ink cartridge until it clicks into place*

# Improving Print Quality

---

## Checking the Print Head Nozzles



If you find that the printout is unexpectedly faint or that dots are missing, you may be able to identify the problem by checking the print head nozzles.

**Note:**

- ❑ *You cannot clean the print head if the message “ink out” is displayed or the ink icon flashes to show ink out or ink low on the LCD panel. Replace the appropriate ink cartridge first.*
- ❑ *Make sure the CD/DVD tray is not inserted in the printer and the CD/DVD guide is up before using the Nozzle check utility.*

## Using the control panel buttons

Follow the steps below to check the print head nozzles using the control panel buttons.

1. Check that no warnings or errors are displayed on the LCD panel.
2. Make sure that A4 or Letter size paper is loaded in the sheet feeder.
3. Press the  maintenance button in Advanced mode.
4. Press the  button to position the cursor at Nozzle Check and press the OK button.
5. Follow the instructions displayed in the LCD panel and press the OK button.

- The nozzle check pattern is printed out. See the following illustration. If it is necessary to clean the print head, press the OK button, then select Head Cleaning.

The printer will print an operation check page that includes a nozzle check pattern. Below are sample printouts.

Good sample

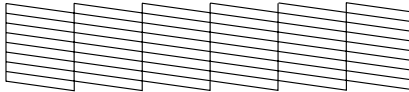

Print head needs to be cleaned

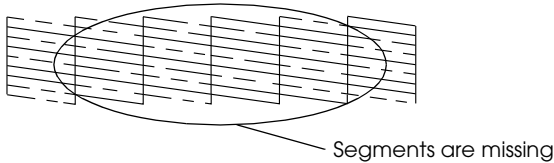

The above sample may be shown in black and white, but the actual test prints in color (CMYK).

If the nozzle check page does not print satisfactorily (for example, if any segment of the printed lines is missing), there is a problem with the printer. This could be a clogged ink nozzle or a misaligned print head.

See the next section for details on cleaning the print head.

---

## ***Cleaning the Print Head***



If you find that the printout is unexpectedly faint or that dots are missing, you may be able to solve these problems by cleaning the print head, which ensures that the nozzles are delivering ink properly.

**Note:**

- ❑ *Print head cleaning consumes some ink. To avoid wasting ink, clean the print head only if print quality declines; for example, if the printout is blurry or the color is incorrect or missing.*
- ❑ *Use the Nozzle Check utility first to confirm that the print head needs to be cleaned. This saves ink.*
- ❑ *You cannot clean the print head if the message “ink out” is displayed or the ink icon flashes to show ink low on the LCD panel. In case of ink out, the ink cartridge replacement procedure will start. If you do not want to replace an ink cartridge at this moment, press Stop button to return the print head to its home position.*
- ❑ *Make sure the CD/DVD tray is not inserted in the printer before using the Head Cleaning utility.*

## **Using the control panel buttons**

Follow the steps below to clean the print head using the control panel buttons.

1. Check that no warnings or errors are displayed on the LCD panel.
2. Press the  maintenance button in Advanced mode.
3. Press  button to position the cursor at Head Cleaning and press the OK button.



**Caution:**

*Never turn the power supply to the printer off while the progress meter is displayed in the LCD panel. Doing so may damage the printer.*

4. Follow the instructions displayed in the LCD panel and press the OK button.
5. The print head cleaning starts.



**Note:**

- ❑ *If print quality has not improved after repeating this procedure four or five times, turn the printer off and leave it alone overnight. Then, do the nozzle check again, and repeat the head cleaning if necessary.*
- ❑ *If the print quality still has not improved, at least one of your ink cartridges may be old or damaged and may need to be replaced.  
➔ See “Replacing an Ink Cartridge” on page 64 to replace an ink cartridge before it is empty.*
- ❑ *If print quality remains a problem after replacing the ink cartridges, contact your dealer.*
- ❑ *To maintain print quality, we recommend printing a few pages at least once every month.*

---

## ***Aligning the Print Head***

If you notice a misalignment of vertical lines or horizontal banding, you may be able to solve this problem from the LCD panel.

**Note:**

*Make sure the CD/DVD tray is not inserted in the printer and the CD/DVD guide is up before using the Print Head Alignment utility.*

## ***Using the control panel buttons***

Follow the steps below to align the print head using the control panel buttons.

1. Check that no warnings or errors are displayed on the LCD panel.
2. Press the  maintenance button in Advanced mode.

- Press ▼ button to position the cursor at Print Head Alignment and press the OK button.
- Follow the instructions displayed on the LCD panel and press the OK button. The following alignment sheet is printed.

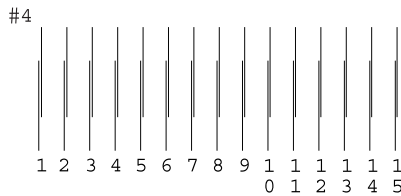
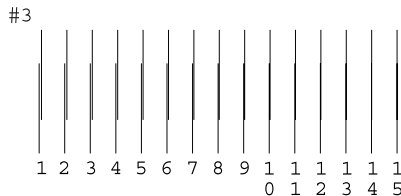
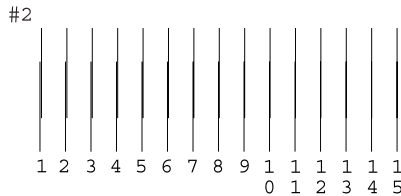
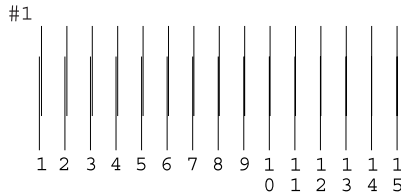

- From the alignment pattern in set #1 on the printed test sheet, choose the vertical line that is aligned best. Press the ▲ or ▼ button to select the corresponding line number and press the OK button.

6. Repeat step 5 for the alignment patterns in sets #2, #3 and #4.
7. Press the OK button to finish.

---

## ***Cleaning the Printer***

To keep your printer operating at its best, clean it thoroughly several times a year as follows.

1. Unplug the printer's power cord.
2. Remove any paper from the sheet feeder.
3. Use a soft brush to carefully clean away all dust and dirt from the sheet feeder.
4. If the outer case or the inside of the sheet feeder is dirty, wipe it with a soft, clean cloth dampened with mild detergent. Keep the printer cover closed to prevent water from getting inside.
5. If the inside of the printer accidentally gets soiled with ink, wipe it off with a damp cloth.
6. If ink have leaked inside the printer, wipe the inside of the printer with a soft, clean cloth.

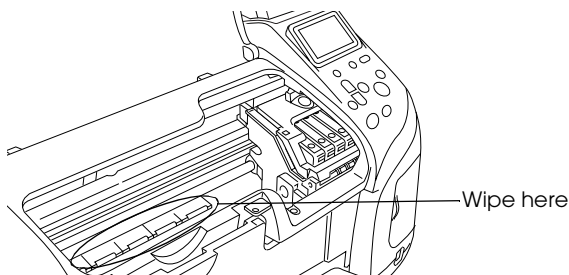

***Warning:***

*Be careful not to touch the gears or rollers inside the printer.*

**Caution:**

- ❑ *Do not apply grease to the metal parts under the print head carriage.*
- ❑ *Never use alcohol or thinner to clean the printer, as these chemicals can damage the components as well as the case.*
- ❑ *Be careful not to get water on the printer mechanism or electronic components.*
- ❑ *Do not use a hard or abrasive brush.*
- ❑ *Do not spray the inside of the printer with lubricants. Unsuitable oils can damage the mechanism. Contact your dealer or a qualified service person if lubrication is needed.*

---

## **Transporting the Printer**

If you need to transport your printer, carefully prepare and repack it as described below using the original box (or a similar box that the printer fits snugly into) and packing materials. Follow the steps below.

**Caution:**

- ❑ *When storing or transporting the printer, do not tilt it, stand it up vertically, or turn it upside down. Otherwise, ink may leak from the cartridge.*
  - ❑ *Leave the ink cartridges installed. Removing the cartridges can dehydrate the printer head and may prevent the printer from printing.*
1. Plug in the printer, then turn on the printer. Wait until the print head returns to the home position, then close the printer cover. Turn off the printer, and then unplug the printer.
  2. Disconnect the interface cable from the printer.

3. Remove the paper from the sheet feeder.
4. Open the printer cover again. Secure the ink cartridge holder to the printer with tape as shown below, then close the printer cover.

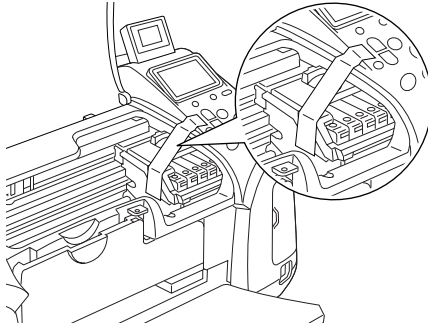

5. Close the CD/DVD guide if it is open. Raise the output tray, close the printer cover and the paper support.
6. Attach the protective materials to both sides of the printer.
7. Repack the printer and power cord in the original box.
8. Keep the printer level during transport.
9. Be sure to remove the protective materials and tape from the printer before using it again.

# Troubleshooting

The solutions herein are for problems when printing directly from a memory card.





---

## Error/Warning Display

You can identify many common printer problems using the display on your printer's LCD panel.

### Error

Display	Solution
<p>Ink out. Black: T0481 Cyan: T0482 Magenta: T0483 Yellow: T0484 Light Cyan: T0485 Light Magenta: T0486</p> <p>The genuine Epson ink cartridges listed above are recommended for replacement.</p>	<p>Replace the ink cartridges shown, with a new ones.</p>
<p>Paper is not set correctly. Set the paper correctly, then press the maintenance button.</p>	<p>Load paper in the sheet feeder, and press the  maintenance button to turn this light off. The printer resumes printing.</p>

<p>A paper jam has occurred. See your printer's documentation for information about cleaning the jam.</p>	<p>Press the  maintenance button to eject the jammed paper. See "The paper jams" on page 87 for details.</p>
<p>Ink cartridges cannot be recognized.  Black: T0481  Cyan: T0482  Magenta: T0483  Yellow: T0484  Light Cyan: T0485  Light Magenta: T0486</p> <p>The genuine Epson ink cartridges listed above are recommended for replacement.</p>	<p>Reinstall the cartridge shown.</p>
<p>Service required.</p> <p>Parts inside your printer are at the end of their service life. See your printer's documentation for details</p>	<p>Contact your dealer.</p>
<p>Multi-page feed error  Multiple pages have been fed into the printer at once, or the wrong paper size has been fed into the printer. Remove and reload the paper, then press the maintenance button.</p>	<p>Remove and reload the paper, then press the  maintenance button.</p>
<p>Close the CD/DVD guide.</p>	<p>Close the CD/DVD guide, then press the  maintenance button.</p> <p>If the CD/DVD tray is inserted, remove the CD/DVD tray, then close the CD/DVD guide.</p>
<p>The CD/DVD tray is not set correctly. Reload the tray, then press the maintenance button.</p>	<p>Reload the CD/DVD tray, then press the  maintenance button.</p>



The inserted card cannot be used with this printer.	Use a compatible and formatted memory card.
Bluetooth Photo Print Adapter error. Disconnect the Adapter from the printer, then reconnect it.	Disconnect the Adapter, then reconnect to the printer.
System error. Simultaneously press and hold the Power and Stop button for 7 seconds to turn off the printer.	Turn the printer off, and, after a few seconds, turn it on again. If the error is not cleared, contact your dealer.

## Warning

Error	Display	Solution
Ink low	Ink icon blinks	Obtain a replacement ink cartridge.
Printing from computer* <sup>1</sup>	Communicating with computer. Please wait.	Start printing from the LCD panel after printing from the computer is completed.
Irregular external device.* <sup>2</sup>	The connected device cannot be used.	Connect on external storage device that is compatible with the printer.

\*1 This warning appears when the Print button is pushed, and it disappears after three seconds.

\*2 This warning is displayed for one second every 3 seconds.

---

## ***Print Quality Problems***

### ***Horizontal banding***

- ❑ Make sure that the printable side of the paper is face up in the sheet feeder.
- ❑ Run the Head Cleaning utility to clear any clogged ink nozzles.  
➔ See “Cleaning the Print Head” on page 71
- ❑ Run the Print Head Alignment utility.  
➔ See “Aligning the Print Head” on page 73
- ❑ Use up ink cartridges within six months after opening their packages.
- ❑ Use the genuine Epson ink cartridges.
- ❑ Check the LCD panel. If the ink icon is flashing or a message is displayed, replace the appropriate ink cartridge.  
➔ See “Replacing an Ink Cartridge” on page 64
- ❑ Make sure that the Paper Type selected in the LCD panel is appropriate for the type of media loaded in the printer.

### ***Vertical misalignment or banding***

- ❑ Make sure that the printable side of the paper is face up in the sheet feeder.
- ❑ Run the Head Cleaning utility to clear any clogged ink nozzles.  
➔ See “Cleaning the Print Head” on page 71

- ❑ Run the Print Head Alignment utility.  
➔ See “Aligning the Print Head” on page 73
- ❑ Make sure that the Paper Type selected in the LCD panel is appropriate for the type of media loaded in the printer.

### ***Incorrect or missing colors***

- ❑ Run the Head Cleaning utility.  
➔ See “Cleaning the Print Head” on page 71

If colors are still incorrect or missing, replace the color ink cartridge. If the problem persists, replace the black ink cartridge.

➔ See “Replacing an Ink Cartridge” on page 64

- ❑ If you have just replaced an ink cartridge, make sure the date on the box has not expired. Also, if you have not used the printer for a long time, replace with new ink cartridges.  
➔ See “Replacing an Ink Cartridge” on page 64

### ***Blurry or smeared printout***

- ❑ Use only paper recommended by Epson.  
➔ See “Paper” on page 98
- ❑ Use genuine Epson ink cartridges.
- ❑ Make sure that the printer is on a flat, stable surface that extends beyond the printer base in all directions. The printer will not operate properly if it is tilted.
- ❑ Make sure that your paper is not damaged, dirty, or too old.
- ❑ Make sure that your paper is dry and that the printable side is facing up.

- ❑ If the paper is curled toward the printable side, flatten it or curl it slightly in the opposite direction.
- ❑ Make sure that the Paper Type setting in your LCD panel is correct.
- ❑ Remove each sheet from the output tray as it is printed, especially if you are using transparencies.
- ❑ If you are printing on glossy media or transparencies, place a support sheet (or a sheet of plain paper) beneath the stack, or load only one sheet at a time.
- ❑ Do not touch or allow anything to come into contact with the printed side of transparencies or paper with a shiny finish. After printing documents on transparencies or glossy media, allow the ink to set for a few hours before handling them.
- ❑ Run the Head Cleaning utility.
  - ➔ See “Cleaning the Print Head” on page 71
- ❑ Run the Print Head Alignment utility.
  - ➔ See “Aligning the Print Head” on page 73

---

## ***Printout Problems Not Related to Print Quality***

### ***Blank pages print***

- ❑ Run the Head Cleaning utility to clear any clogged nozzles.  
➔ See “Cleaning the Print Head” on page 71

### ***Printout has smears***

- ❑ If the paper is curled toward the printable side, flatten it or curl it slightly in the opposite direction.
- ❑ Load and eject dry paper several times. If the problem persists, ink may have leaked inside the printer. In this case, wipe the inside of the printer with a soft, clean cloth.  
➔ See “Cleaning the Printer” on page 76

---

## ***Paper Does Not Feed Correctly***

### ***Paper does not feed***

Remove the stack of paper and make sure of the following:

- ❑ The CD/DVD tray is not inserted in the printer and CD/DVD guide is up when printing on paper.
- ❑ The paper is not curled or creased.
- ❑ The paper is not too old. See the instructions that came with the paper for more information.

- ❑ The paper is not loaded higher than the triangular load-limit mark on the edge guide.
- ❑ The paper stack fits under the tabs inside the edge guides.
- ❑ Paper is not jammed inside the printer. If it is, remove the jammed paper.  
➔ See “The paper jams” on page 87
- ❑ The ink cartridges are not empty. If one is, replace the appropriate cartridge.  
➔ See “Replacing an Ink Cartridge” on page 64



Special loading instructions that came with your paper have been followed. Load the paper again.

➔ See “Loading Single Sheets of Paper” in the online *Reference Guide*

## ***Multiple pages feed***

- ❑ Make sure that the paper stack is flush with or lower than the triangular load-limit mark on the edge guide.
- ❑ Make sure that the paper stack fits under the tabs inside the edge guides.
- ❑ Make sure that the left edge guide is snug to the left edge of the paper.
- ❑ Make sure that the paper is not curled or folded. If so, flatten it or curl it slightly toward the opposite side before loading.
- ❑ Remove the stack of paper and make sure that the paper is not too thin.  
➔ See “Paper” on page 98
- ❑ Fan the edges of the stack to separate the sheets, then reload the paper.

## The paper jams

Press the  maintenance button to eject the jammed paper. If the error does not clear, turn the printer off, the printer cover and the CD/DVD guide. Remove all of the paper inside, including any torn pieces, then close the CD/DVD guide. Reload the paper, then press the  maintenance button to resume printing.

### **Note:**

*If you cannot remove a foreign object easily by yourself, do not use force and do not disassemble the printer. Call your dealer for assistance.*

If your paper jams frequently, make sure of the following:

- The paper is smooth, not curled or wrinkled.
- The paper is of high quality.
- The printable side of the paper is face up in the sheet feeder.
- The paper stack was fanned before loading.
- The paper is not loaded above the triangular load-limit mark on the left edge guide.
- The paper stack fits under the tabs inside the edge guides.
- The number of sheets in the paper stack does not exceed the limit specified for that media.
- The left edge guide is adjusted to fit your paper.
- The printer is on a flat, stable surface that extends beyond the printer base in all directions. The printer will not operate properly if it is tilted.

## ***Paper improperly loaded***

If you have loaded the paper too far into the printer, the printer cannot feed the paper correctly. Turn the printer off and gently remove the paper. Then turn the printer on and reload the paper properly.

## ***Paper is not ejected fully or is wrinkled***

- ❑ If the paper does not eject fully, press the  maintenance button, then open the printer cover and remove the paper. Also, check the Paper Size setting in the LCD panel. If the paper is wrinkled when it comes out, it may be damp or too thin. Load a new stack.

### ***Note:***

*Store any unused paper in its original packaging in a dry area.*

## ***CD/DVD tray is ejected when sending a CD/DVD print job***

If the CD/DVD tray is ejected when you send a CD/DVD print job and an error message appears on the LCD panel or PC screen, follow the instructions on the LCD panel to clear the error.



---

## **Printer Does Not Print**

### **LCD panel is off**

- ❑ Press the  power button to make sure that the printer is on.
- ❑ Turn off the printer and make sure that the power cord is securely plugged in.
- ❑ Make sure that your outlet works and is not controlled by a wall switch or timer.

### **LCD panel displays a warning or error message**

If the LCD panel displays a warning or error message, follow the instructions. See “Error/Warning Display” on page 79 for the explanation of warnings and error messages.

### **LCD panel came on and then went out**

The printer’s voltage may not match the outlet rating. Turn off the printer and unplug it immediately. Then, check the printer labels.







**Caution:**

*If the voltage does not match, DO NOT PLUG YOUR PRINTER BACK IN. Contact your dealer.*

### **Maintenance light is flashing or on**

- ❑ Make sure that there is no packing material in the printer.
- ❑ If the printer sounds like it is trying to print, but is unable to, run the Head Cleaning utility. See “Cleaning the Print Head” on page 71.

- ❑ If the  maintenance light is on and paper is jammed in the printer, remove the paper from the printer.
- ❑ If the  maintenance light is on and no paper is loaded, load more paper in the sheet feeder.
- ❑ If the  maintenance light is flashing, ink is low. Obtain a replacement cartridge of the appropriate type. To determine which cartridge is low, see “Replacing an Ink Cartridge” on page 64.
- ❑ If the  maintenance light is on and ink is out, replace the appropriate ink cartridge.

---

## ***Print Head Carriage Problem***

If the carriage cover does not close or the print head carriage does not move to its home position, open the carriage cover and push the ink cartridges down until they click into place.

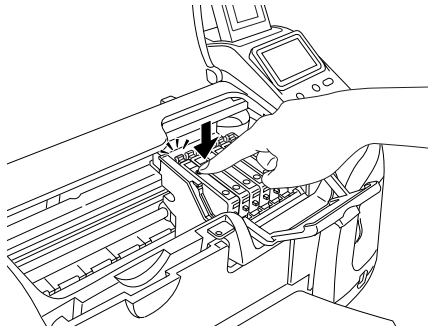

---

## ***Printing Problems when Using the Bluetooth Photo Print Adapter***

If you are having difficulties using your printer with the Bluetooth Photo Print Adapter, refer to the "Using the Bluetooth Photo Printer Adapter" in the online *Reference Guide*.

---

### ***Communication Error***

#### ***The power light does not turn on***

---

<b>Cause</b>	<b>What to do</b>
The power cord may not be properly plugged into the electrical outlet.	Turn off the printer and check the power cord connections between the printer and the electrical outlet. Then turn the printer back on.
The electrical outlet may be controlled by an outside switch or an automatic timer.	Make sure that the switch is turned on or plug another electrical device into the outlet to check whether the outlet is operating properly.

---

## ***The power light is on but nothing prints***

<b>Cause</b>	<b>What to do</b>
Your computer may not be properly connected to the printer.	Perform the setup procedure described in the <i>Setup</i> sheet.
The interface cable may not be plugged in securely.	Check both ends of the interface cable between the printer and the computer.
You may not be using the correct interface cable.	If you are using the USB interface, use a Revision 1.1 cable.
Some error may have occurred.	➔ See “Error/Warning Display” on page 79
Your printer may have broken.	Print the nozzle check pattern to see if the printer is broken. ➔ See “Running a printer operation check” in the online <i>Reference Guide</i>  If the printer does not print, it may be broken. Contact your dealer.
Your application software is not properly set up for your printer.	Make sure that the printer is selected in your application software.
Your computer system’s memory is too small to handle the volume of data in your document.	Try reducing the image resolution of your document in the application software, or install more memory in your computer if you can.

---

## ***Canceling Printing***

If you encounter problems while printing, you may need to cancel printing.

To stop printing in progress, press Stop button. The printer will cancel all print jobs and stop printing, and eject any pages or CD/DVD tray that were printing. Depending on the printer's status, printing may not stop immediately.

# ***Customer Support***

---

## ***Contacting Customer Support***

If your Epson product is not operating properly and you cannot solve the problem using the troubleshooting information in your product documentation, contact customer support services for assistance. Check your Pan-European Warranty Document for information on how to contact EPSON Customer support. They will be able to help you much more quickly if you give them the following information:

- Product serial number  
(The serial number label is usually on the back of the product.)
- Product model
- Product software version  
(Click About, Version Info, or similar button in the product software.)
- Brand and model of your computer
- Your computer operating system name and version
- Names and versions of the software applications you normally use with your product

---

## ***Technical Support Web Site***

Go to <http://www.epson.com> and select the Support section of your local EPSON web site for the latest drivers, FAQs, manuals and other downloadables.

Epson's Technical Support Web Site provides help with problems that cannot be solved using the troubleshooting information in your printer documentation.

# Options and Consumable Products

---

## Options

The options below are available for your printer.

### **Bluetooth Photo Print Adapter**

The optional Bluetooth Photo Print Adapter is a wireless communication module used to print from digital still cameras, digital video cameras, PDAs, Mobile PCs, and other devices that support Bluetooth wireless technology without cables when connected to the printer.

Bluetooth unit C824\*\*\*

**Note:**

*The asterisk is a substitute for the last digit of the product number, which varies by location. Refer to the "Using the Bluetooth Photo Printer Adapter" in the online Reference Guide.*

---

## Consumable products

The following ink cartridges and Epson special media are available for your printer.



## Ink cartridges

You can use the following cartridges with your printer.

Type of ink	Product numbers of ink
Black ink cartridge	T0481
Color ink cartridge	
Cyan	T0482
Magenta	T0483
Yellow	T0484
Light Cyan	T0485
Light Magenta	T0486

**Note:**

*The product numbers of ink cartridges may vary by location.*

## Media Types

Epson offers specially designed media for ink jet printers to meet most high-quality printing needs.

➔ See “Media type settings” on page 105

**Note:**

❑ *The availability of special media varies by location.*

❑ *For the latest information on media available in your area, contact EPSON customer support web site.*

➔ *See “Contacting Customer Support” on page 94*

# Printer Specifications

---

## Printer Specifications

### Printing

<b>Printing method</b>	On-demand ink jet
<b>Nozzle configuration</b>	Monochrome (black) 90 nozzles Color (cyan, magenta, yellow, light cyan, light magenta) 450 nozzles (90 × 5 colors)

### Paper

**Note:**

*Since the quality of any particular brand or type of paper may be changed by the manufacturer at any time, Epson cannot guarantee the quality of any non-Epson brand or type of paper. Always test a sample of paper stock before purchasing large quantities or printing large jobs.*

## Paper specifications

Single sheets:

Size	A4 210 × 297 mm 10 × 15 cm (4 × 6 in) 13 × 18 cm (5 × 7 in) A6 105 × 148 mm A5 148 × 210 mm B5 182 × 257 mm 9 × 13 cm (3.5 × 5 in) 13 × 20 cm (5 × 8 in) 20 × 25 cm (8 × 10 in) Letter 8 1/2 × 11 in Legal 8 1/2 × 14 in
Paper types	Plain bond paper, special paper distributed by Epson
Thickness (for plain bond paper)	0.08 to 0.11 mm (0.003 to 0.004 inch)
Weight (for plain bond paper)	64 g/m <sup>2</sup> (17 lb) to 90 g/m <sup>2</sup> (24 lb)

### Note:

- Poor quality paper may reduce print quality and cause paper jams or other problems. If you encounter problems, switch to a higher grade paper.*
- Do not load curled or folded paper.*
- Use paper under normal conditions:  
Temperature 15 to 25°C (59 to 77°F)  
Humidity 40 to 60% RH*

Envelopes:

Size	Envelope #10 4 1/8 × 9 1/2 in Envelope DL 110 × 220 mm Envelope C6 114 × 162 mm Envelope 132 × 220 mm
Paper types	Plain bond paper, air mail
Weight	75 g/m <sup>2</sup> (20 lb) to 95 g/m <sup>2</sup> (24 lb)

## Printable area

Single sheets and index cards

Normal

Borderless

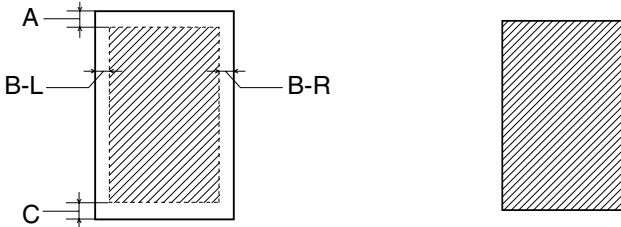

Diagonal lines show printable area.

- A: The minimum top margin is 3.0 mm (0.12").
- B-L: The minimum left margin is 3.0 mm (0.12").
- B-R: The minimum right margin is 3.0 mm (0.12").
- C: The minimum bottom margin is 3.0 mm (0.12").

**Note:**

*Depending on the type of media being used, print quality may decline in the top and bottom areas of the printout, or the area may be smeared.*

## Ink Cartridges

Black (T0481)  
 Cyan (T0482)  
 Magenta (T0483)  
 Yellow (T0484)  
 Light Cyan (T0485)  
 Light Magenta (T0486)

<b>Color</b>	Black, Cyan, Magenta, Yellow, Light Cyan and Light Magenta
<b>Cartridge life</b>	Within 6 months of opening the package, at 25°C (77°F)
<b>Temperature</b>	Storage: -20 to 40°C (-4 to 104°F) 1 month at 40°C (104°F) Freezing: * -16°C (3.2°F)

\* Ink thaws and is usable after approximately 3 hours at 25°C (77°F).



### **Caution:**

- ❑ *Epson recommends the use of genuine Epson ink cartridges. Epson warranties do not cover damage to your printer caused by the use of ink cartridges not manufactured by Epson.*
- ❑ *Do not use an ink cartridge if the date on the package has expired.*
- ❑ *Do not refill the ink cartridge. The printer calculates the amount of ink remaining using an IC chip on the ink cartridge, so even if the cartridge is refilled, the IC chip will report that it is empty.*

## Mechanical

<b>Paper path</b>	Sheet feeder, rear entry
<b>Sheet feeder capacity</b>	About 120 sheets at 90 g/m <sup>2</sup> (24 lb) paper
<b>Dimensions</b>	Storage Width: 498 mm (19.6 inches) Depth: 264 mm (10.4 inches) Height: 225 mm (8.9 inches)
	Printing Width: 498 mm (19.6 inches) Depth: 476 mm (18.7 inches) Height: 289 mm (11.4 inches)
<b>Weight</b>	6.0 kg (13.2 lb) without the ink cartridges

## Electrical

	<b>120 V Model</b>	<b>220-240 V Model</b>
<b>Input voltage range</b>	99 to 132 V	198 to 264 V
<b>Rated frequency range</b>	50 to 60 Hz	
<b>Input frequency range</b>	49.5 to 60.5 Hz	
<b>Rated current</b>	0.4 A (Max. 0.6 A)	0.2 A (Max. 0.4 A)
<b>Power consumption</b>	Approx. 13 W (ISO10561 Letter Pattern) Approx. 3.0 W in Sleep mode	
	Approx. 0.3 W in powered off mode	Approx. 0.5 W in powered off mode

**Note:**

Check the label on the back of the printer for the voltage of your printer.

**Environmental**

Temperature	Operation: 10 to 35°C (50 to 95°F)  Storage: -20 to 60°C (-4 to 140°F)  1 month at 40°C (104°F)
Humidity	Operation*: 20 to 80% RH  Storage*: 5 to 85% RH

\* Without condensation

## **Built-in card slots**

Card Slots	CF Type II card slot	Compatible with "CF+ and CompactFlash Specification 1.4"
	SmartMedia card slot	Compatible with "SmartMedia Standard 2000"
	Memory Stick/MemoryStick PRO card slot	Compatible with "Memory Stick Standard version 1.3" Compatible with "Memory Stick Standard Memory Stick PRO Format Specifications version 1.0"
	SD/MMC card slot	Compatible with "SD Memory Card Specifications / PART1. Physical Layer Specification Version 1.0" Compatible with "MultiMediaCard Standard"
	xD-Picture card Slot	Compatible with "xD-Picture card™ Card Specification Version 1.00"



Compatible memory cards	CompactFlash SmartMedia* Memory Stick Memory Stick PRO Memory Stick Duo** Memory Stick PRO Duo** MagicGate Memory Stick MagicGate Memory Stick Duo** Microdrive SD (Secure Digital) Card MultiMediaCard miniSD card** xD-Picture Card
Voltage Requirements	3.3 v Maximum current is 500 mA

\* Maximum capacity is 128 MB.

\*\* Adapter required.

## ***Media type settings***

The Media Type setting determines what other settings are available, so you should always make this setting first.

Refer to the corresponding media type under which it is grouped (shown in larger type). For some media, there are several Media Type settings from which to choose.

## **Plain**

Plain paper

Envelopes

EPSON Premium Ink Jet Plain Paper (A4) S041214

EPSON Bright White Ink Jet Paper (A4) S041442

## **Iron-On**

EPSON Iron-On Cool Peel Transfer Paper (A4) S041154

## **Matte**

EPSON Matte Paper Heavyweight (A4) S041256

## **Photo**

EPSON Photo Paper (A4) S041140  
S041622  
S041857

EPSON Photo Paper (10 × 15 cm/4 × 6 in) S041134

## **Glossy**

EPSON Premium Glossy Photo Paper (A4) S041287  
S041624

EPSON Premium Glossy Photo Paper S041822  
(10 × 15 cm/4 × 6 in)

EPSON Premium Glossy Photo Paper S041875  
(13 × 18 cm/5 × 7 in)

EPSON Premium Semigloss Photo Paper (A4) S041332

EPSON Premium Semigloss Photo Paper S041765  
(10 × 15cm/4 × 6 in)

## Stickers

EPSON Photo Stickers 4

S041176

EPSON Photo Stickers 16

S041144

---

## External Storage Devices

Connectivity	Universal Serial Bus* Bit rate: 12 Mbps (Full speed device) Connector type: USB Series A Recommended cable length: Less than 2 meters
Power supply	Maximum current is 500 mA.

\* Not all USB devices are supported. Contact your regional customer support for details.

---

## ***Standards and Approvals***

U.S. model:

Safety	UL 60950 CSA No.60950
EMC	FCC Part 15 Subpart B Class B CSA C108.8 Class B

European model:

Low Voltage Directive 73/23/EEC	EN 60950
EMC Directive 89/336/EEC	EN 55022 Class B EN 55024 EN 61000-3-2 EN 61000-3-3