

# EPSON®

# dreamio™

## Home Projector

# EMP-TW20

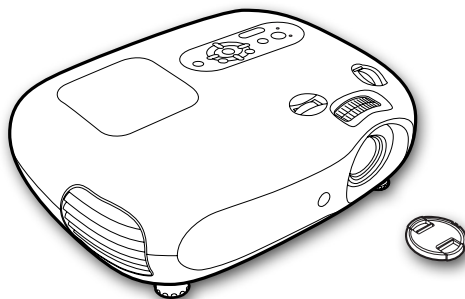

**EN** Quick Start Guide

**DE** Kurzanleitung

**FR** Guide de démarrage rapide

**IT** Guida di avvio rapido

**ES** Guía de inicio rápido

**PT** Guia de Referência Rápida

**NL** Introductiehandleiding

**DA** Introduktion

**FI** Pika-aloitusopas

**NO** Hurtigveiledning

**SV** Snabbstartsguide

**CS** Úvodní příručka

**HU** Bevezetés

**PL** Przewodnik szybkiego startu

**SK** Stručná príručka

**BG** Ръководство за бърз старт

**RO** Ghid de pornire rapidă

**EE** Lühijuhend

**LV** Ātrās darba uzsākšanas pamācība

**LT** Trumpas pradžios vadovas

**EL** Οδηγός γρήγορης εκκίνησης

**TR** Hızlı Başlangıç Kılavuzu

**SL** Priročnik za hitri zagon

**HR** Kratke upute

**MK** Прирачник брз почеток

**SR** Uputstvo za brz početak

**RU** Руководство по быстрой установке

**AR** دليل البداية السريعة

**FA** راهنمای سریع برای شروع بکار

<b>EN</b>	For detailed information, refer to the User's Guide.
<b>DE</b>	Ausführliche Informationen finden Sie im Benutzerhandbuch.
<b>FR</b>	Pour plus d'informations, reportez-vous au guide utilisateur.
<b>IT</b>	Per informazioni dettagliate, consultare la guida per l'utente.
<b>ES</b>	Para obtener información detallada, consulte la guía del usuario.
<b>PT</b>	Para mais informações, consulte o Manual do Utilizador.
<b>NL</b>	Raadpleeg de gebruikershandleiding voor uitgebreide informatie.
<b>DA</b>	Se brugervejledningerne for at få yderligere oplysninger.
<b>FI</b>	Lisätietoja on käyttöoppaassa.
<b>NO</b>	Hvis du vil ha mer detaljert informasjon, kan du se brukerhåndboken.
<b>SV</b>	Detaljerad information finns i användarhandboken.
<b>CS</b>	Podrobné informace naleznete v Uživatelské příručce.
<b>HU</b>	Részletes ismertetés a Használati útmutatóban található.
<b>PL</b>	Szczegółowe informacje zawiera Przewodnik użytkownika.
<b>SK</b>	Podrobné informácie nájdete v Príručke používateľa.

<b>BG</b>	За подробна информация направете справка с Ръководството за потребителя.
<b>RO</b>	Pentru informații detaliate, consultați User's Guide (Ghidul utilizatorului).
<b>EE</b>	Täpsemat teavet vt kasutusjuhendist.
<b>LV</b>	Sīkāka informāciju skatīt lietošanas instrukcijā.
<b>LT</b>	Detalios informacijos ieškokite Vartotojo vadove.
<b>EL</b>	Για περισσότερες πληροφορίες, δείτε τον Οδηγό χρήσης.
<b>TR</b>	Ayrıntılı bilgi için Kullanım Kılavuzuna başvurun.
<b>SL</b>	Podrobnejše informacije lahko najdete v navodilih za uporabo.
<b>HR</b>	Detaljnije informacije, potražite u vodiču za korisnike.
<b>MK</b>	За подетални информации видете во Упатството за чпотреба.
<b>SR</b>	Za detaljnije informacije pogledajte Korisničko uputstvo.
<b>RU</b>	Для получения дополнительной информации см. Руководство пользователя.
<b>AR</b>	للحصول على المعلومات التفصيلية، ارجع إلى "دليل المستخدم".
<b>FA</b>	برای اطلاعات مشروح به راهنمای کاربر رجوع شود.

<b>EN</b>	Content of the box
<b>DE</b>	Packungsinhalt
<b>FR</b>	Contenu de la boîte
<b>IT</b>	Contenuto della confezione
<b>ES</b>	Contenido del paquete
<b>PT</b>	Conteúdo da embalagem
<b>NL</b>	Inhoud van de doos
<b>DA</b>	Æskens indhold
<b>FI</b>	Laatikon sisältö
<b>NO</b>	Innholdet i esken
<b>SV</b>	Innehåll i lådan
<b>CS</b>	Obsah balení
<b>HU</b>	A doboz tartalma
<b>PL</b>	Zawartość opakowania
<b>SK</b>	Obsah balenia

<b>BG</b>	Съдржание на кутията
<b>RO</b>	Conținutul cutiei
<b>EE</b>	Kasti sisu
<b>LV</b>	Komplektācija
<b>LT</b>	Dėžės turinys
<b>EL</b>	Περιεχόμενα της συσκευασίας
<b>TR</b>	Kutunun içeriği
<b>SL</b>	Vsebina paketa
<b>HR</b>	Sadržaj paketa
<b>MK</b>	Содржина на кутијата
<b>SR</b>	Sadržaj kutije
<b>RU</b>	Содержимое упаковки
<b>AR</b>	محتوى الصندوق
<b>FA</b>	محتویات جعبه

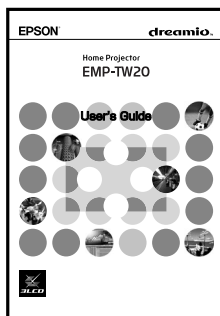
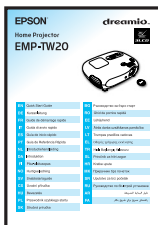
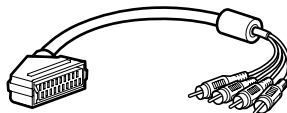
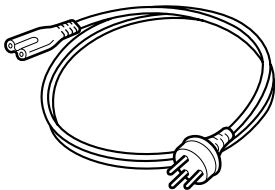
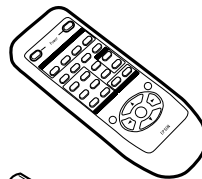
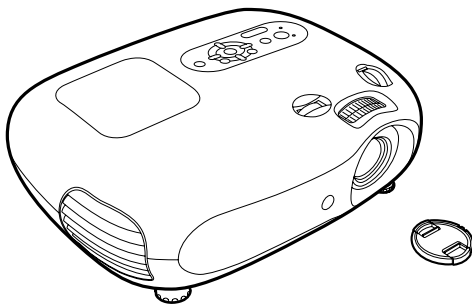

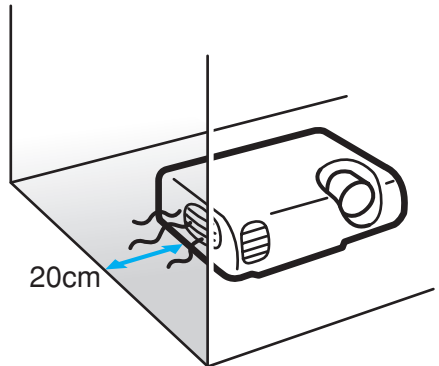
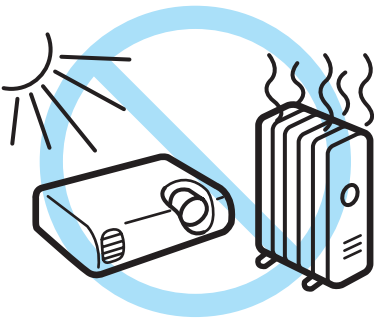
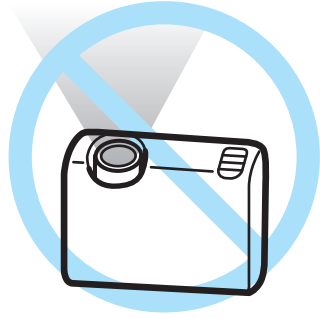
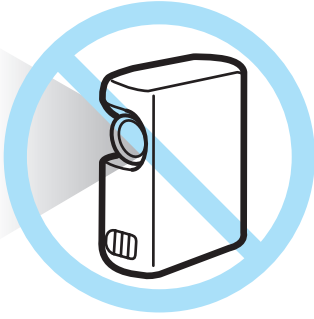

## 16 : 9

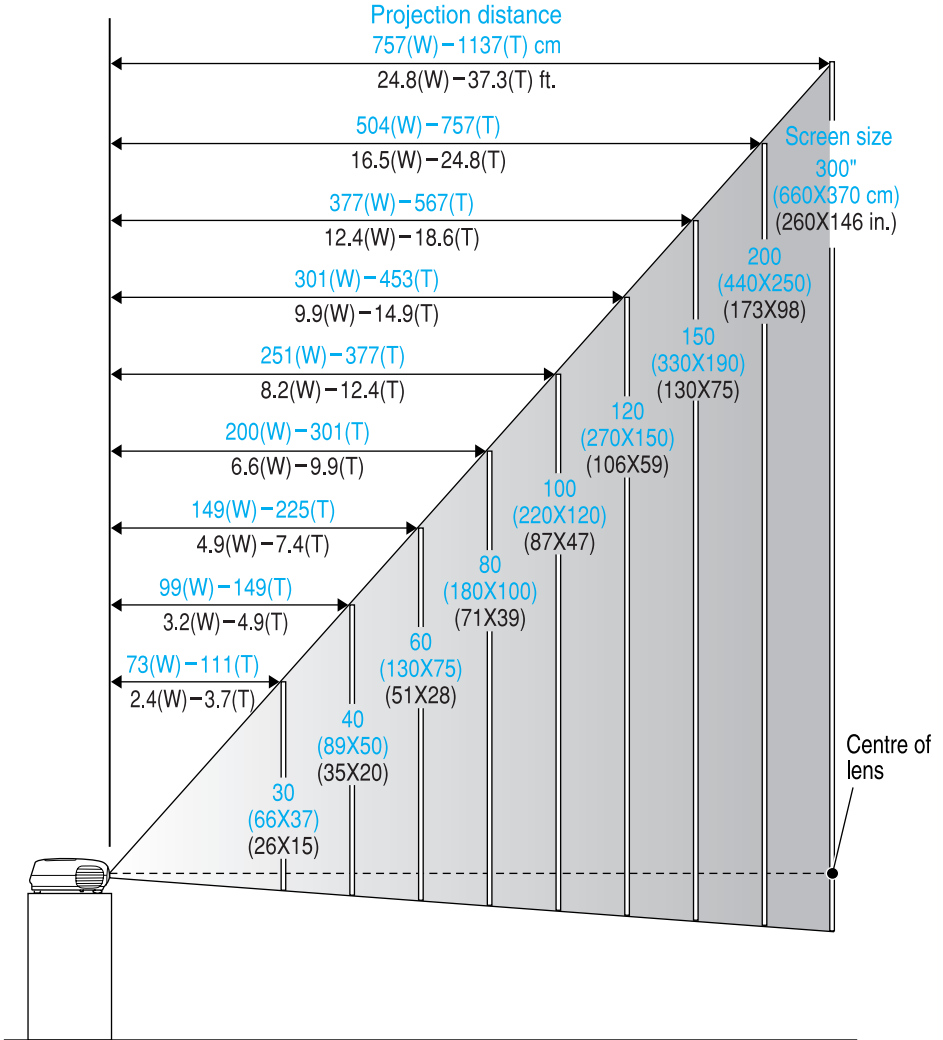

4 : 3

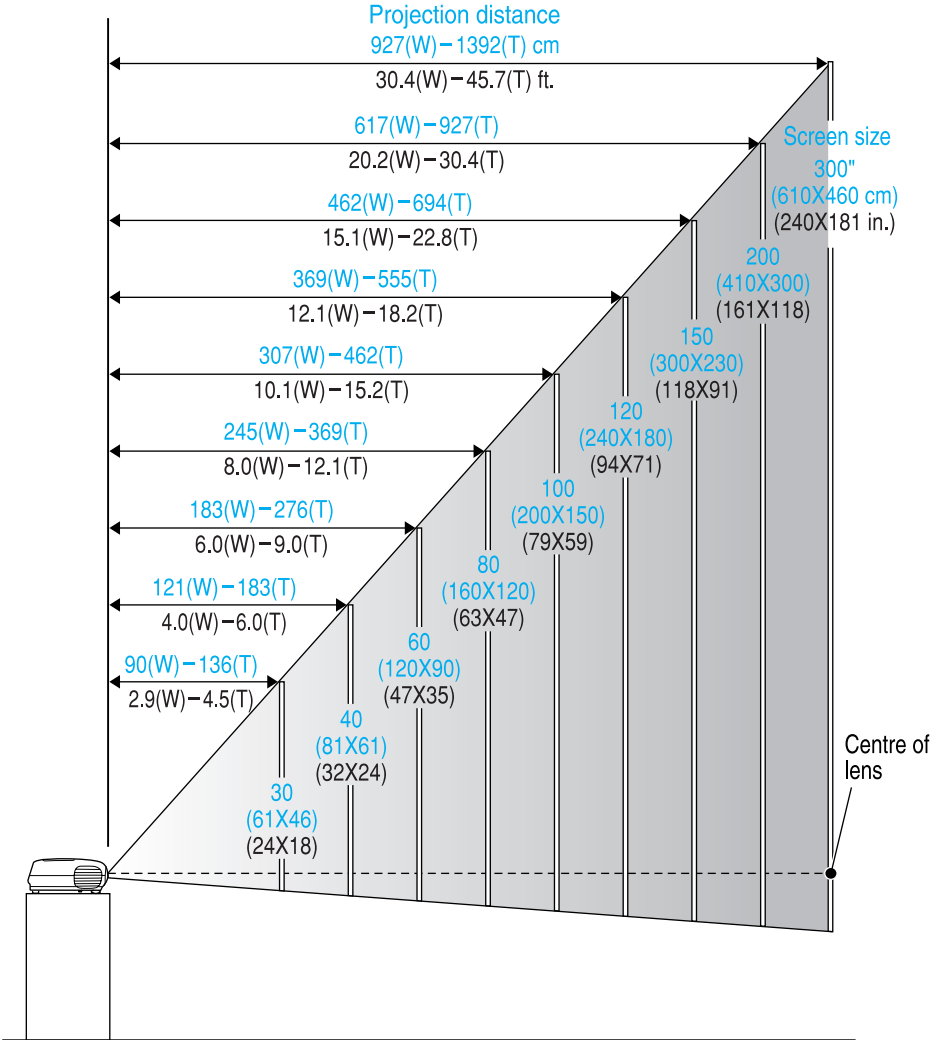



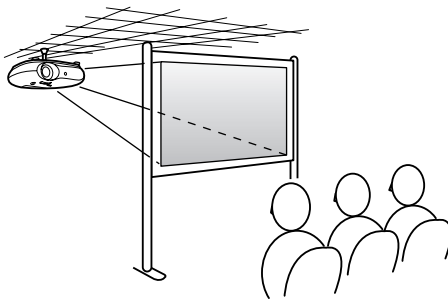
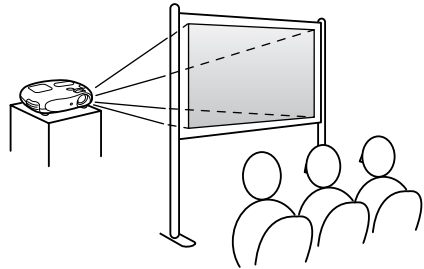
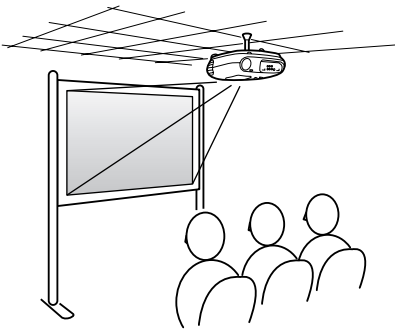
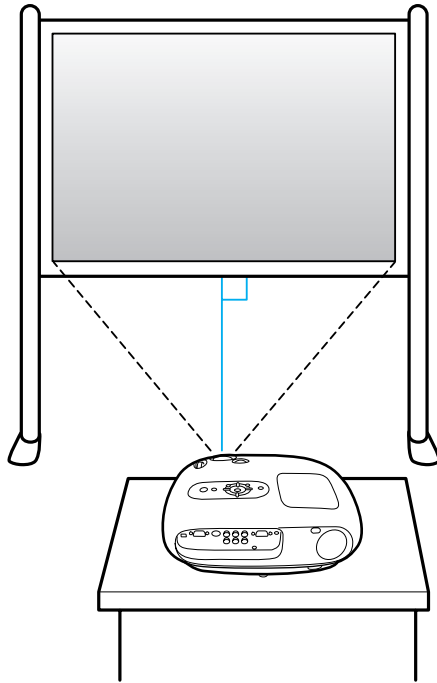

# 2

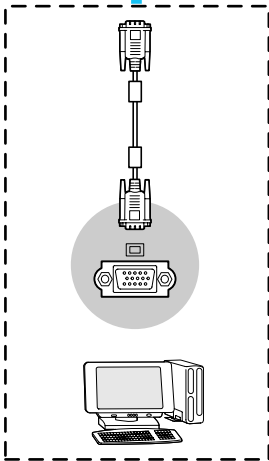
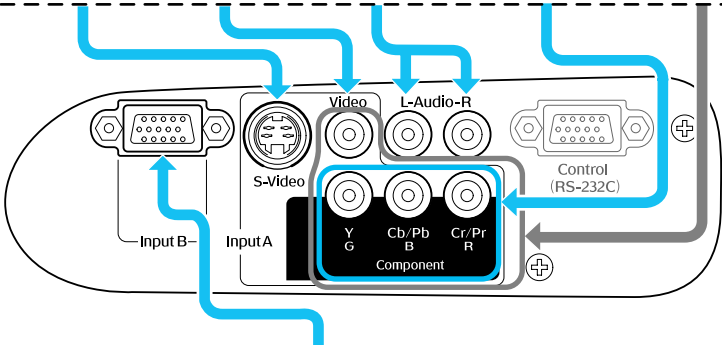
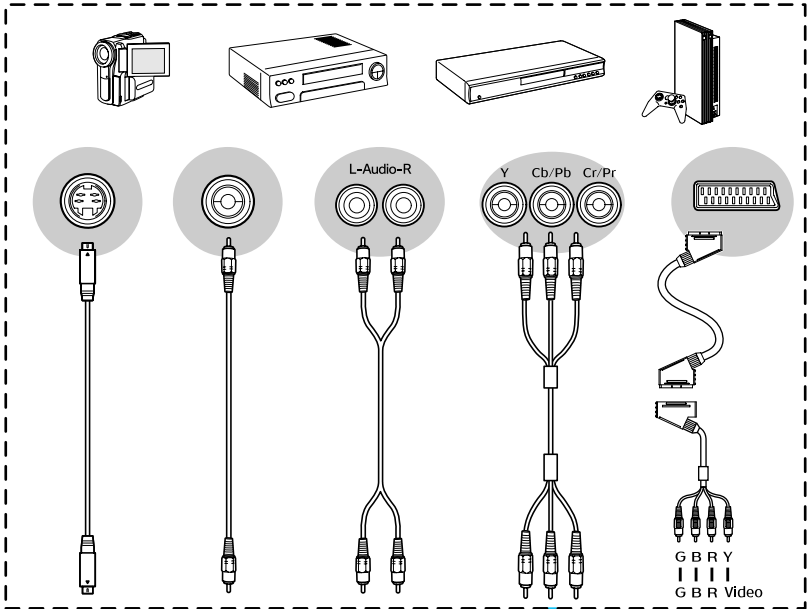

# 3

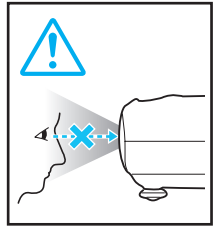
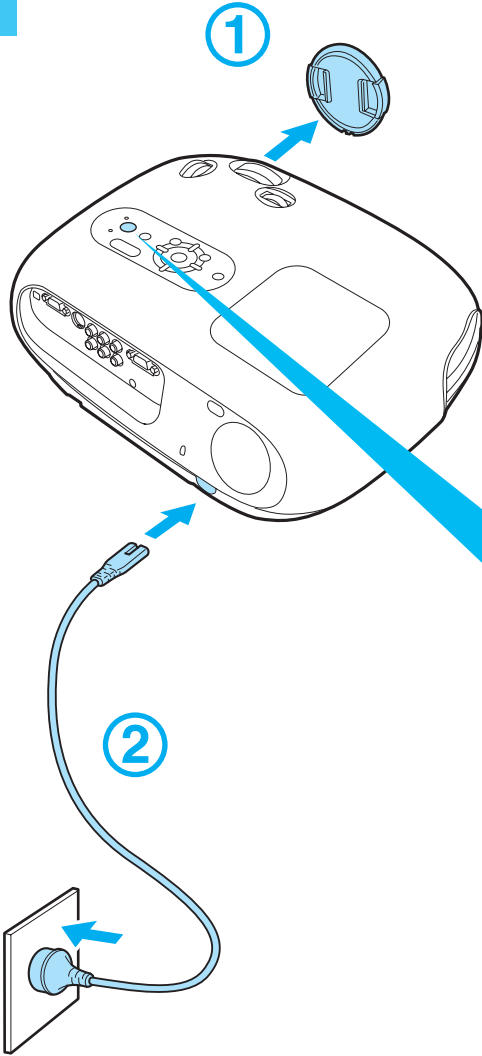

### 4

Power Source Menu

Power

Source

Menu

Enter

Power

Source

Input A Input B S-Video V

A/V Mute Aspect Still Auto

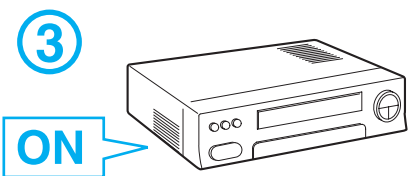

4

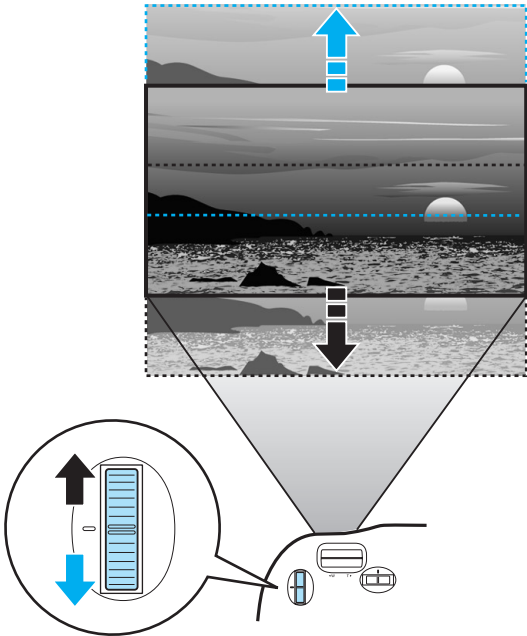
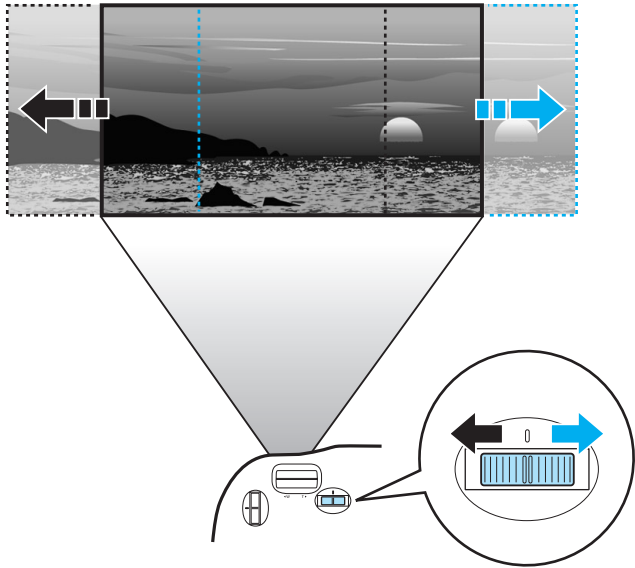

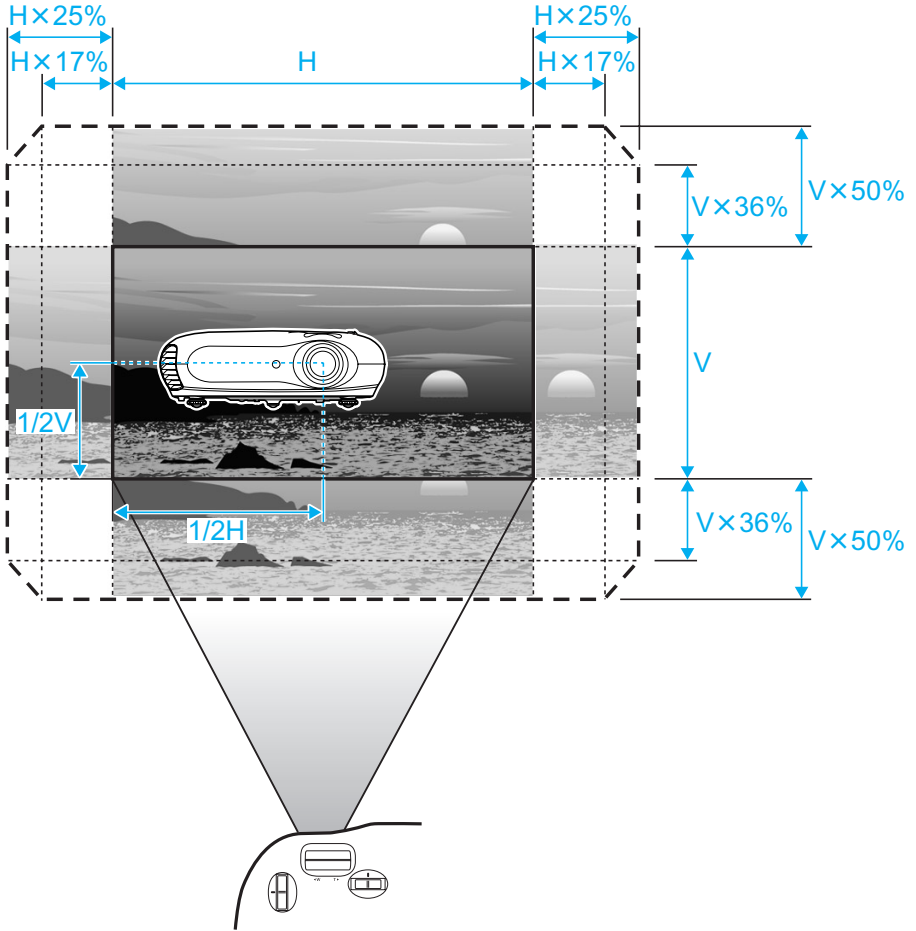

5

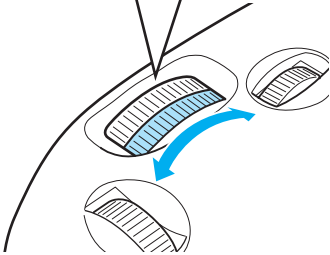
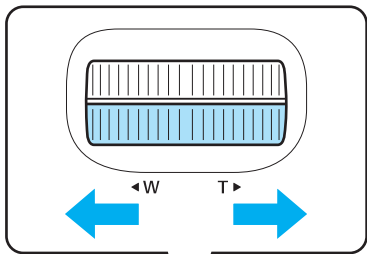
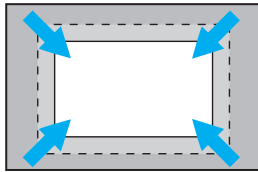
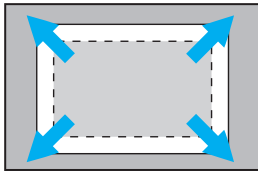
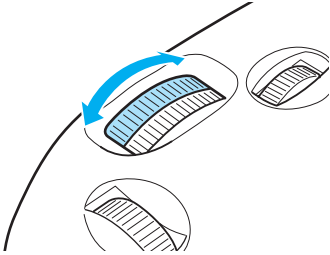
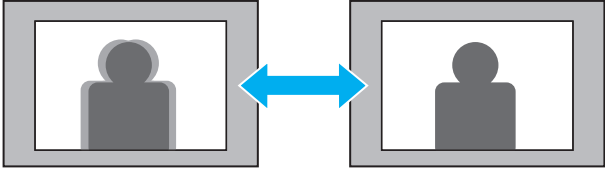

# 6

1

OFF

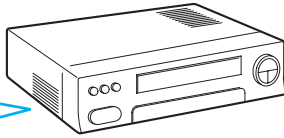

2

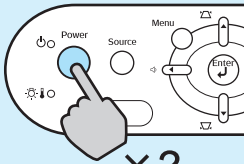

x2

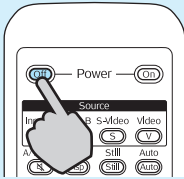

20 Sec.

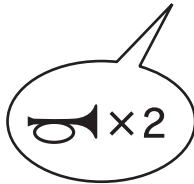

4

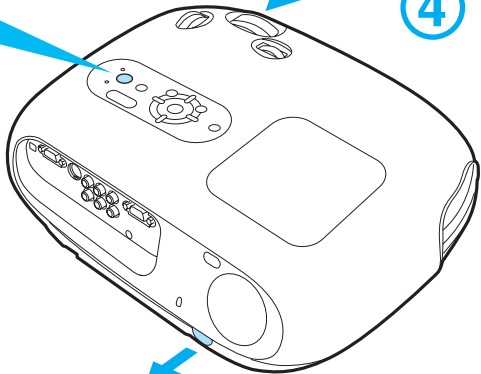

3

