

# EPSON

## ColorPage EPL-C8000

# Quick Reference

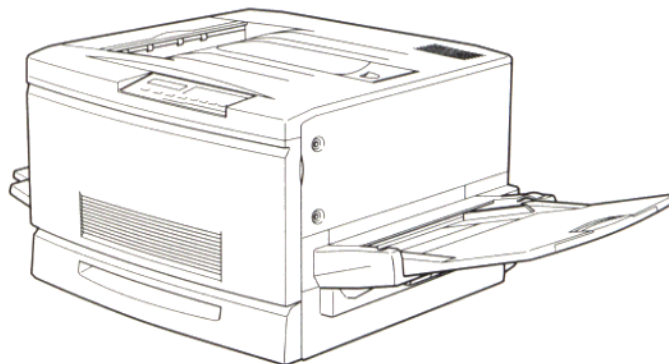
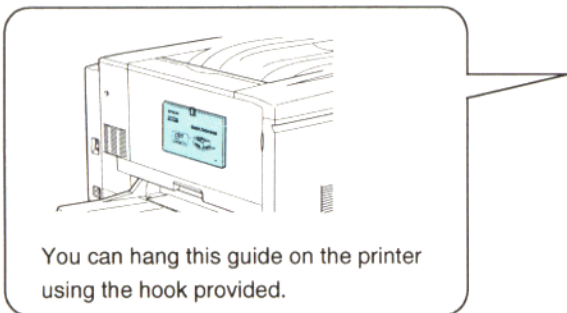

## Replacing Consumable Products

You need to replace the following consumable products when you are given a notice message on the control panel display or in EPSON Status Monitor 2.

Toner Cartridge (Yellow)	S050016
Toner Cartridge (Magenta)	S050017
Toner Cartridge (Cyan)	S050018
Toner Cartridge (Black)	S050019
Waste Toner Collector	S050020
Photoconductor Unit	S051061
Fuser Oil Roll	S052002

### Replacing a toner cartridge

1. Open the front cover. If you can see the color that you need to replace in the install window, go to step 3. If you see a different color, go to the next step.
2. Push the switch up, then release it to unlock the cartridges. Turn the round knob until it stops. Repeat until the cartridge you want to replace appears.

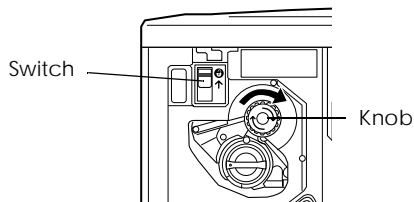

3. Turn the cartridge knob counterclockwise 90 degrees. Then pull the cartridge out of the slot.

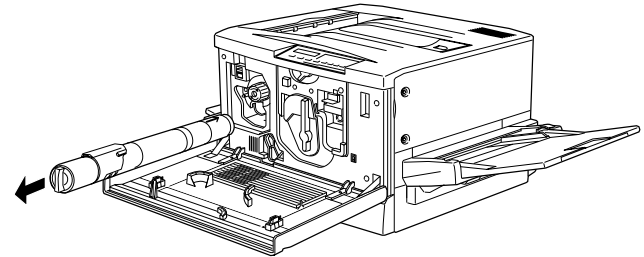
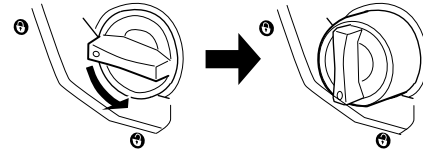

4. Take a new cartridge out of package and gently shake it back and forth and front to back.

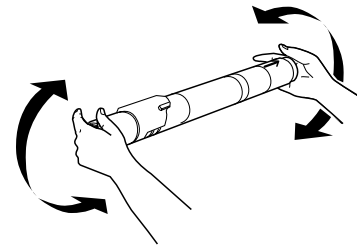

5. Hold the cartridge arrow side up and insert it all the way into the cartridge slot. Then turn the cartridge knob clockwise 90 degrees.

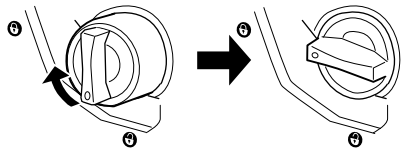
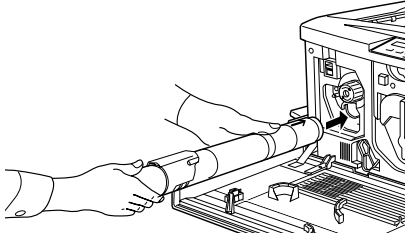

6. If you need to replace another cartridge, repeat steps 2 to 5.
7. Close the front cover.

## Replacing the photoconductor unit

1. Turn off the printer and open the front cover.

### **Note:**

*When replacing the photoconductor unit, make sure to turn off the printer.*

2. Turn the large lever counterclockwise 90 degrees.

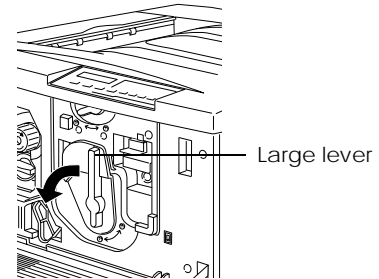

3. Turn the small lever to the right.

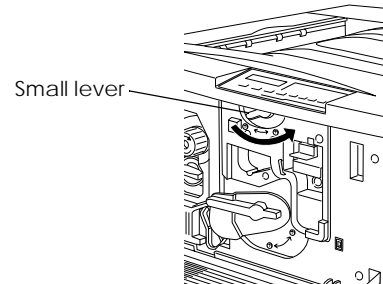

4. Pull the photoconductor unit out about 30 cm.

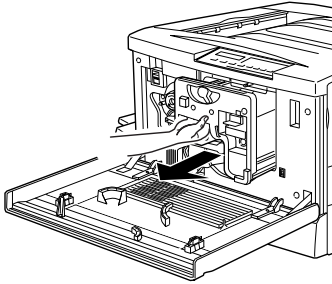

5. Grab the handle at the top of the photoconductor unit and gently pull it all the way out.

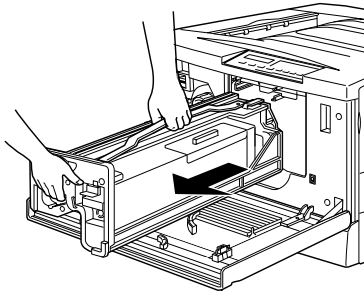

6. Take a new photoconductor unit out of its package and remove the protective sheet.



**Caution:**

- ❑ Be sure not to touch or scratch the surface of the drum.
- ❑ When replacing the photoconductor unit, avoid exposing it to room light any longer than necessary,

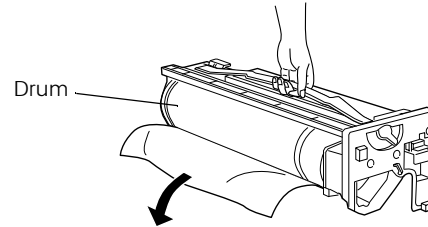

7. Hold the handle at the top of the photoconductor unit and place the unit on the guide rails. Insert it all the way into the printer.

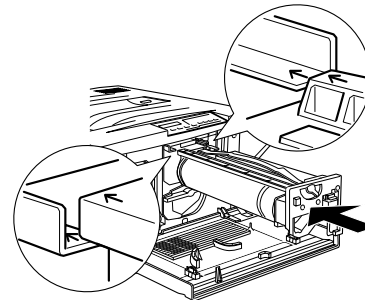

8. Turn the small lever left.

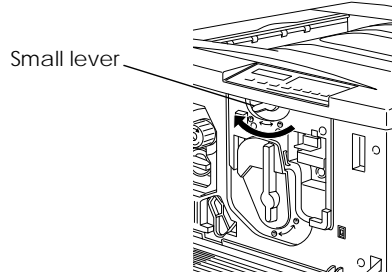

9. Turn the large lever clockwise 90 degrees. Then close the front cover.

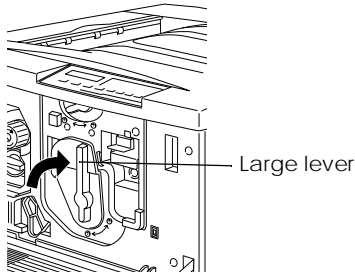

## Replacing the waste toner collector

1. Open the front cover.
2. Grasp the handle and tab of the waste toner collector to release the lock. Then pull out the collector.

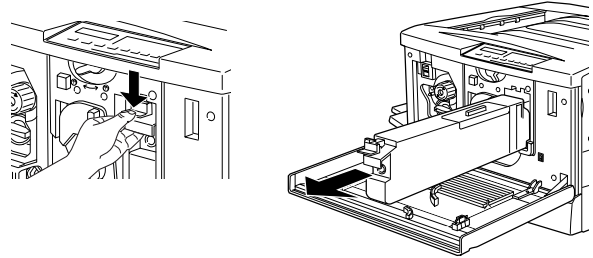

3. Take out a new waste toner collector. Hold the handle of the collector and insert it into the slot all the way until the tab clicks.

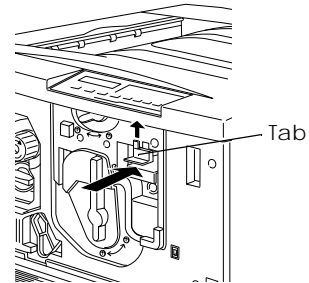

4. Close the front cover.

## Replacing the fuser oil roll

1. Pull down the face-up tray. Hold the handle of the fuser unit and pull it all the way out.

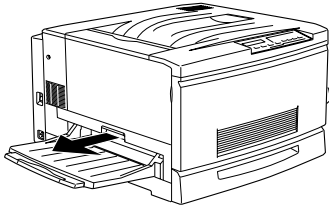

2. Grab the handle of the fuser oil roll and remove it.



### **Warning:**

*Be careful not to touch the fuser, which is marked **CAUTION! HIGH TEMPERATURE** or the adjoining areas. If the printer has been in use, the fuser and the area around it can be very hot.*

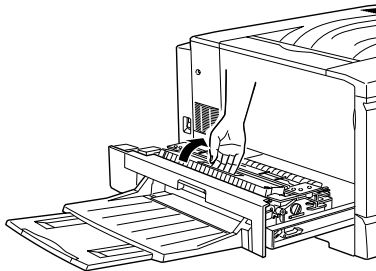

3. Take a new fuser oil roll from the box and remove the cover and two shipping pins.

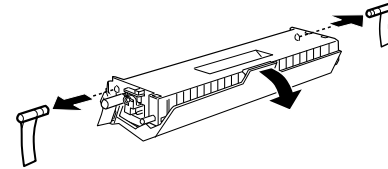

4. Hold the roll handle and insert it into the fuser unit, matching the green marks on the roll and unit.

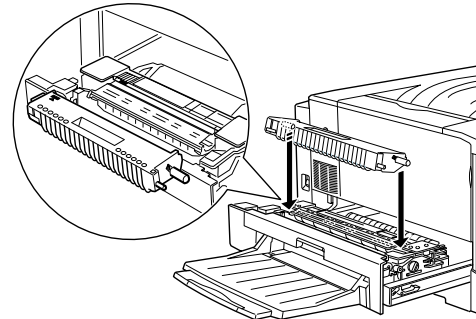

5. Push the roll down firmly until it clicks into place.

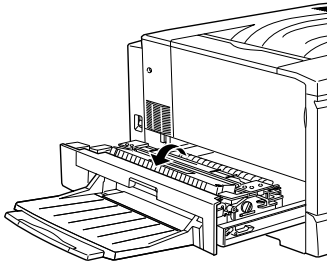

6. Push the fuser unit into the printer until it clicks.

---

## Clearing Jammed Paper

Make sure into follow these points when you clear jammed paper:

- ❑ Do not remove jammed paper by force. Pull it gently in order to avoid tearing the paper which can cause pieces to remain in the printer.
- ❑ If jammed paper is torn and remains in the printer, or if paper is jammed in an area not mentioned in this manual, contact your dealer.



### **Warning:**

*Be careful not to touch the fuser, which is marked **CAUTION! HIGH TEMPERATURE** or adjoining areas. If the printer has been in use, the fuser and the area around it can be very hot.*

## Clearing the paper cassette

1. Pull the paper cassette out slowly until it stops. Remove any jammed paper.

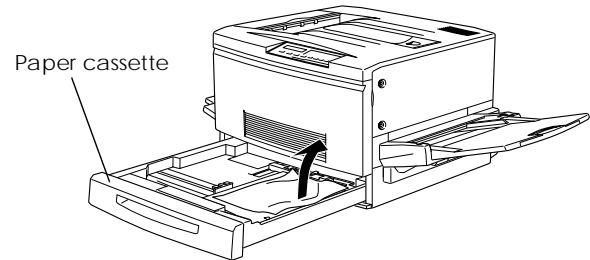

2. Replace the paper stock in the paper cassette and close it.
3. Pull the paper path unit out slowly until it stops. Pull any jammed paper out from the bottom of the paper path unit.

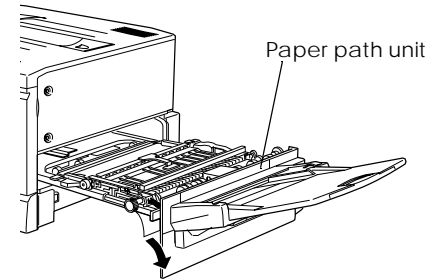

4. Close the paper path unit.

## Clearing the MP tray

1. Pull the jammed paper out gently.

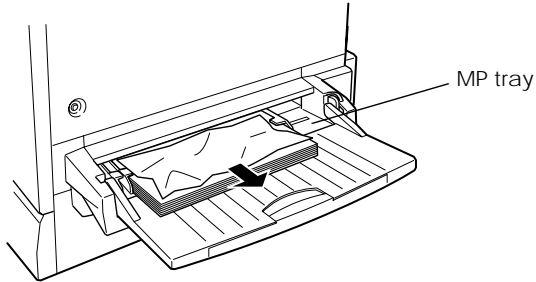

2. Pull the paper path unit out until it stops. Open the cover inside the unit by grasping the handle and pulling upwards.

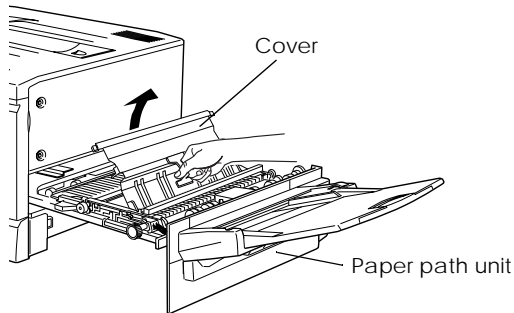

3. Turn the knob on the unit. The jammed paper comes out. After the jammed paper is ejected halfway, pull the paper up and out.

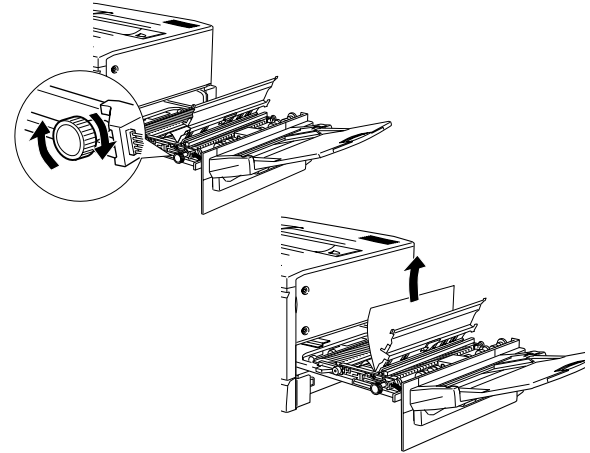

4. Close the unit cover.

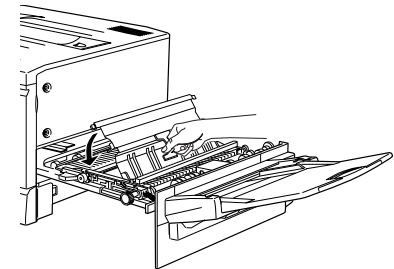

5. Close the paper path unit firmly.



## Clearing the fuser unit



### Caution:

When paper is jammed the path to the face-up tray, clear it from the fuser unit.

1. Pull the fuser unit out gently until it stops. Grasp the handle of the fuser oil roll and remove it.

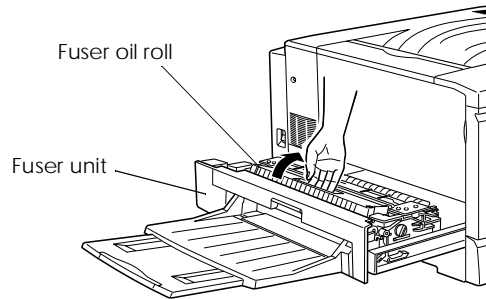

### Warning:

- ❑ Be careful not to touch the fuser, which is marked **CAUTION! HIGH TEMPERATURE** or the adjoining areas. If the printer has been in use, the fuser and the area around it can be very hot.
- ❑ Reattach the fuser oil roll as soon as you clear the jammed paper.
- ❑ The roll should be always kept horizontally. Do not tilt it or place it against something, as it can cause oil leakage and reduced print quality.

2. Turn the knob in the fuser unit to eject any jammed paper. Pull out the jammed paper.

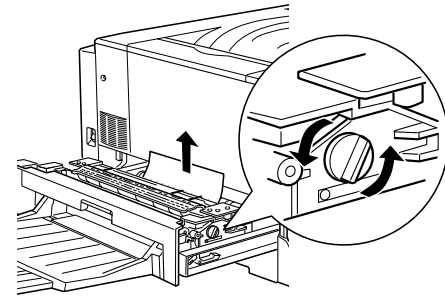

3. Reattach the fuser oil roll.

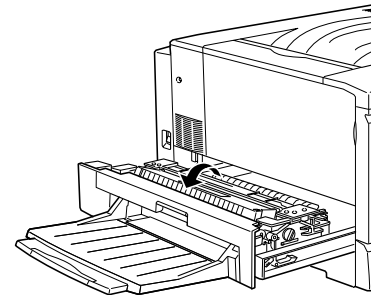

4. Close the fuser unit firmly.

## Clearing the output path cover



### **Caution:**

*When paper is jammed the path to the face-down tray, clear it from the fuser unit.*

1. Open the output path cover at the left side of the printer.
2. Remove all jammed paper. If paper has jammed at the top of the output path, gently lift it up. If it has jammed near the bottom of the output path cover, carefully pull it out of the printer.

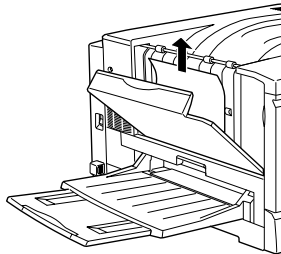
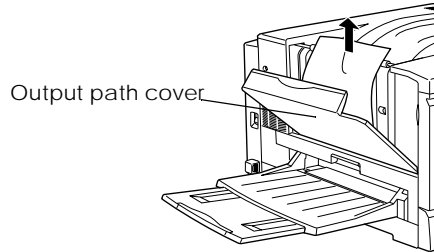

3. Close the output path cover.

## Clearing optional large capacity paper unit

1. Open the feeder cover on the right side of the paper unit. Pull any jammed paper out gently.

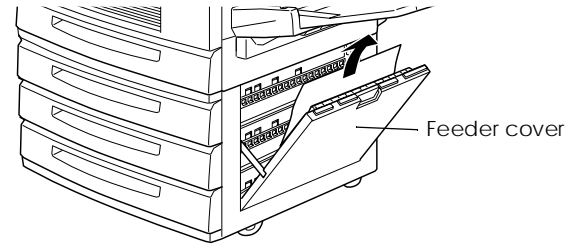

2. Close the feeder cover.

### **Note:**

*If the paper is jammed in the paper cassette mounted on the paper unit, see "Clearing the paper cassette".*

---

## Control Panel Messages

### Status message list

Messages	Description
Form Feed	The printer is feeding paper.
Ready	The printer is ready to print.
Reset	The printer's current interface has been reset and the buffer is cleared.
Reset All	All printer settings have been reset to the user default configuration, the last settings that were saved.
Reset to Save	You should reset the printer to save the current settings.
Self Test	The printer is running a self-diagnostic program.
Standby Level X (X = 1 or 2)	The printer is turned on, but is in energy-saving mode.
Warming Up	The printer is warming up.
Writing DIMM A	The printer is writing the settings to ROM module A.

### Error message list

Messages	Description
Check OHP Sheet	You have load transparencies facing the wrong direction or with the wrong side up, or you tried to load a transparency other than EPSON Color Laser Transparencies. The printer stops loading in order to avoid damage. You must clear any jammed sheets from the MP tray and paper path unit.
Check Paper Size	The paper size setting is different from the size loaded in the printer. Check to see if the correct size of paper is loaded in the tray; then press the Continue button.
Exiting Paper Jam	Paper is jammed at an ejection area like the face-up tray.
Exit Cover Open	The output path cover is open. Close it.
Feed Jam	Paper is jammed at a loading entrance area like the paper cassette or MP tray.

Messages	Description
Feeder Cover Open	The feeder cover of the optional large capacity paper unit is open. Close it.
Format Error DIMM A	An unformatted DIMM has been inserted. If the DIMM has been formatted, but is unreadable, format the DIMM again. If, after reformatting, the DIMM is still unreadable, take it to your dealer for repair or replacement.  To clear this error either press the Continue button or turn off the printer and remove the DIMM.
Front Cover Open	The front cover is open. Close it.
Fuser Unit Open	The fuser unit is open. Close it.
Illegal Aux I/F Card	The printer cannot communicate with the installed optional interface card. Turn off the printer and remove the card, then reinstall it.
Illegal DIMM A	The printer cannot read the installed optional DIMM. Turn off the printer and remove the DIMM.

Messages	Description
Image Optimum	There is insufficient memory to print the page using the specified print quality. The printer automatically reduces the print quality so it can continue printing. If the printout is not acceptable, try simplifying the page by limiting the number of graphics or reducing the number of fonts or font sizes.  Turn off the printer then resend the print data.  Turn the Image Optimum setting off on the Config menu of Selectype.
Insert Oil Roll	The fuser oil roll is not installed or is installed incorrectly.
Insert Photoconductr	The photoconductor unit is not installed, or is installed incorrectly. Turn off the printer, then install or reinstall the photoconductor unit.
Insert Waste T Box	The waste toner collector is not installed or is installed incorrectly.

Messages	Description
Insert XXX XXX: The selected paper source is indicated.	The indicated (XXX) paper source is open. Close it.
Irregular Density	You have tried to print a document with too-great a density. The printer stops loading paper in order to avoid damage. You need to clear any jammed paper from the MP tray and paper path unit.
Maintenance Req XXXX XXXX: Number is indicated.	A part inside the printer need to be replaced. Contact your dealer and report what number (XXXX) appears.
Manual Feed XXX YYYY XXX: The selected paper source is indicated. YYYY: The selected paper size is indicated.	The printer is waiting for media to be inserted manually.

Messages	Description
Mem Overflow	The printer has insufficient memory available for the current task. To correct the error, press the Continue button on the control panel. If the message remains, reset the printer. You can also clear this message by turning the printer off, waiting 10 seconds, and then turning it back on.
Menus Locked	This message appears if you try to change a printer setting when the buttons have been locked.
Need Memory	The printer has insufficient memory available for the current task. Add more memory to your printer.
Oil Roll Near Empty	There is little oil remaining in the fuser oil roll. Early replacement with the new fuser oil roll is recommended.
Paper Jam	Paper is jammed at the fuser unit.

Messages	Description
<p>Paper Out XXX YYYY</p> <p>XXX: The selected paper source is indicated.</p> <p>YYYY: The selected paper size is indicated.</p>	<p>There is no paper in the specified paper source (XXX). Load paper of the indicated size (YYYY) into the source.</p>
<p>Paper Set XXX YYYY</p> <p>XXX: The selected paper source is indicated.</p> <p>YYYY: The selected paper size is indicated.</p>	<p>The paper loaded in the specified paper source (XXX) does not match the required paper size (YYYY). Replace the loaded paper with the correct size and press Continue.</p> <p>If you press Continue without replacing paper, the printer prints on the loaded paper although it does not match the required size.</p>
<p>Paper Unit Open</p>	<p>The paper path unit is open. Close it.</p>
<p>Photocondctr Trouble</p>	<p>The installed photoconductor unit has a problem. Turn off the printer, then remove the photoconductor unit and install the new photoconductor unit.</p>

Messages	Description
<p>Print Overrun</p>	<p>The required time to process the print data exceeds the print engine speed because the current page is too complex. Press the Continue button to resume printing. If this message appears again, turn on Page Protect in the Config Menu of the SelecType setting.</p> <p>If you continue to receive this message when printing a particular page, try simplifying the page by limiting the number of graphics or reducing the number and size of fonts.</p>
<p>Replace Oil Roll</p>	<p>No oil remain in the fuser oil roll. Replace it with a new fuser oil roll.</p>
<p>Replace Photocondctr</p>	<p>The photoconductor unit has reached the end of its service life. Turn off the printer, then remove the photoconductor unit and install the new photoconductor unit.</p>
<p>Replace Waste T Box</p>	<p>The waste toner collector has become full. Replace it with a new waste toner collector.</p>

Messages	Description
Service req eXXXX xxxx: Number is indicated.	A controller error or a print engine error has been detected. Write down the error number listed on the display and turn off the printer. Wait at least 10 seconds and then turn it back on. If this error still occurs, turn off the printer, unplug the power cord, and contact a qualified service person.
Turn Paper	Paper is loaded in the incorrect direction (you may have loaded the paper short edge first). Turn paper 90 degrees and reload it (you need to load paper the long-edge first.)
Warning Photocondctr	The photoconductor unit is approaching the end of its service life. Early replacement is recommended to maintain print quality.
Waste T Box Nearfull	The waste toner collector is almost full of toner. Early replacement with the new waste toner collector is recommended.

Messages	Description
Write Error DIMM A	This message indicates an internal error in the printer. Reset the printer. If this error persists, consult your EPSON dealer.
Wrong Photoconductor	You have installed a photoconductor not designed for this printer. Turn off the printer. Remove the photoconductor unit and install a photoconductor unit designed for your printer (S051061).
XXXX Toner Crtg Out XXXX: Letter(s) of Y, M, C, and/or K is indicated.	Indicated (XXXX) toner cartridge is not installed in the printer. Install the proper toner cartridge.
XXXX Toner Low XXXX: Letter(s) of Y, M, C, and/or K is indicated.	Little toner remains in the indicated (XXXX) toner cartridge(s). Early replacement with the new toner cartridge is recommended.
XXXX Toner Out XXXX: Letter(s) of Y, M, C, and/or K is indicated.	There is no toner remaining in the indicated (XXXX) toner cartridge(s). Replace it with the new toner cartridge.



**EPSON**  
**ColorPage**  
**EPL-C8000**

Quick Reference