

EPSON®

QUICK REFERENCE GUIDE

MM PROJECTOR
ULTI EDIA

EMP-713/703/503



Be sure to read the Owner's Manual thoroughly before using this projector.

WARNING

Never look into the lens while the projector's power is turned on.

INDEX ►

- Adjust the distance between the projector and the screen until the desired image size is obtained.

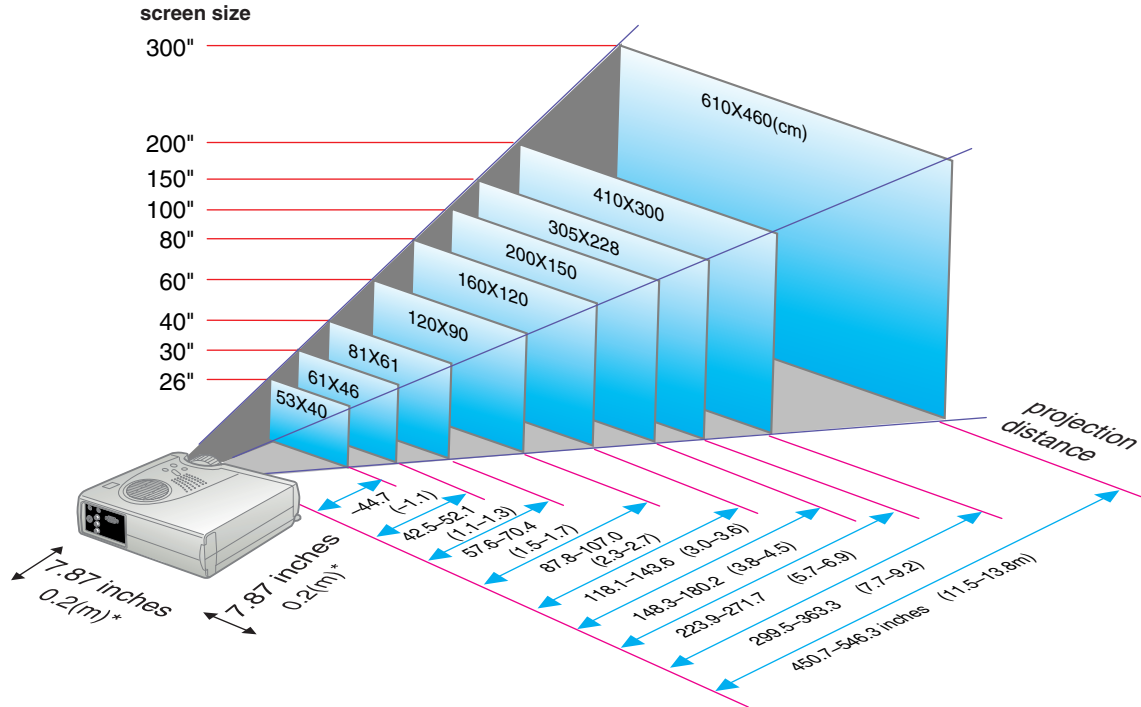

* When installing to wall, leave a space of about 7.87 inches (0.2m) between the projector and the wall.

Connections

 Pages 6,22 of Owner's Manual

Tip

Depending on the shape of the computer monitor terminal, it may not be possible to make connections with the accessory computer cable. Please convert it using a commercially available adapter, etc.

* Turn off the power for both the projector and the other equipment before connecting them.

● Connecting to a Computer

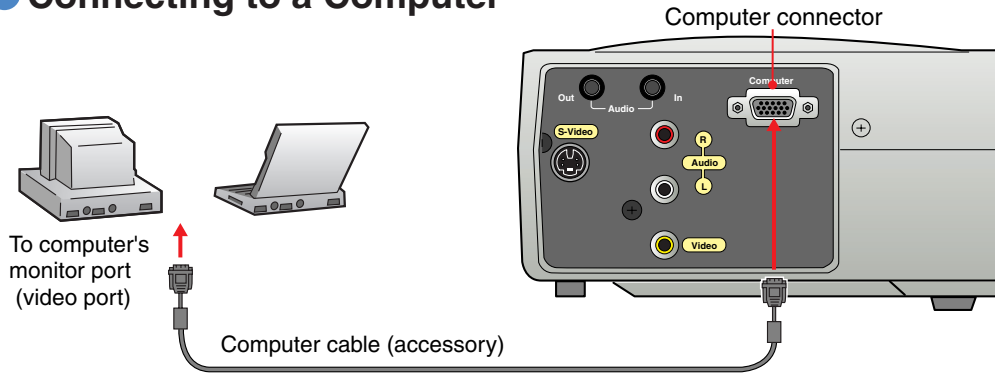

● Connecting to a Video Source

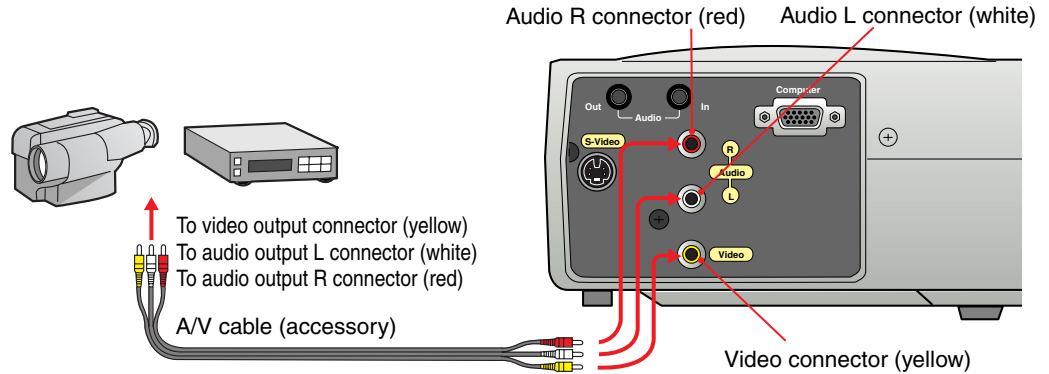

Projecting



Pages 29,30 of Owner's Manual

1 Connect the power cord to the projector.

2 Connect the power cord to an electrical outlet.

The indicator (A) will light orange.

3 Turn on the power for the input source.

In the case of a VCR, press the PLAY button.



4 Rotate the zoom lever to the central position to extend the lens.

5 Remove the lens cover.

Power

6 Press the  to turn on the projector's power.

If using the remote control, set the R/C switch to the ON position and then press the

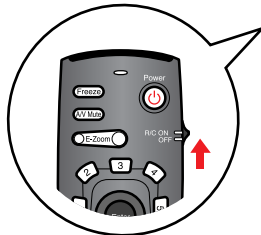

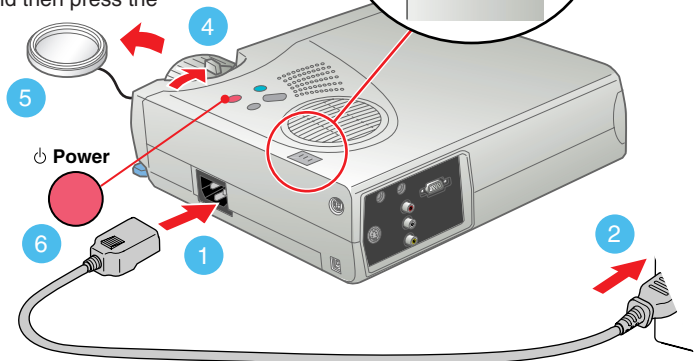
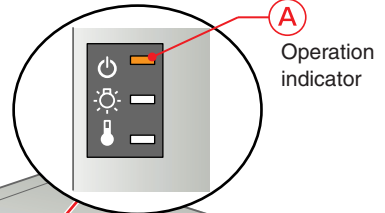

(A) will start flashing green and projection will start.
(Warm-up in progress)











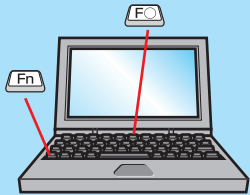





Tip

If a laptop computer or a computer with a LCD screen has been connected to the projector, you may need to change the output destination for video signals depending on the computer keys ( or ) or the computer's settings. The output destination can normally be changed by holding down the computer's  and pressing one of the Function keys.

Once the source has been changed, after a short wait the projector will start projecting. If the output has been changed to external output, only the external output should be used. For details, refer to the documentation provided with your computer.



Examples of changing output

NEC	 + 
Panasonic	 + 
TOSHIBA	 + 
IBM	 + 
SONY	 + 
FUJITSU	 + 
Macintosh	After restarting the computer, change the Control Panel monitor and sound settings so that Mirroring is active.

If images do not appear ...

Change the input signal.

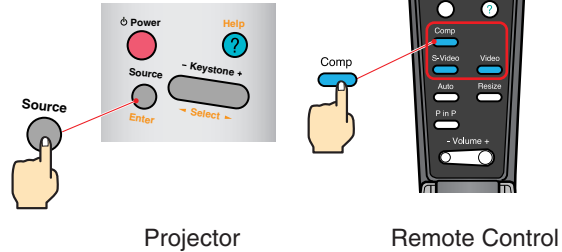

If you have other problems ...

Refer to the online Help information.

Press , and then follow the instructions.

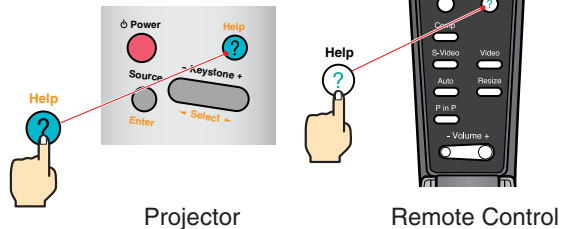

* Refer to Troubleshooting.

Adjustment

 Pages 31,32 of Owner's Manual

Tip

If you change the projection angle, you may get keystone distortion in the images. You can use the  on the projector's control panel to correct keystone distortion.

 See page 7.

● Adjusting the projection angle

Lift the front of the projector while pressing on the foot lever, adjust the amount extension or retraction of the front foot, then adjust the projector's projection angle.

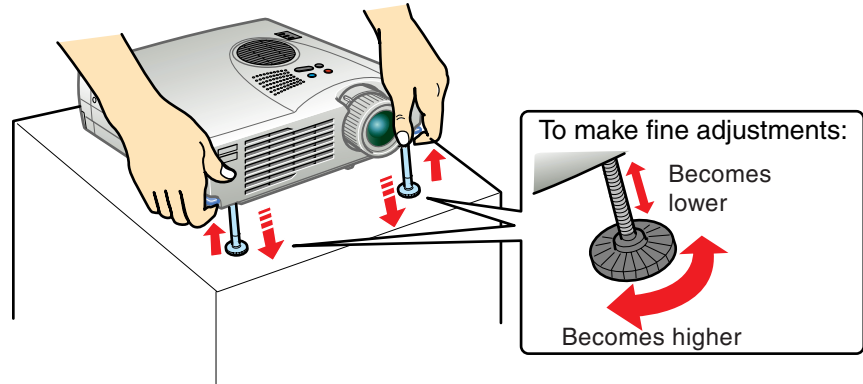

● Adjusting the image size and focus

Focus adjustment

Image size adjustment

Turn to Wide to increase the size
Turn to Tele to reduce the size

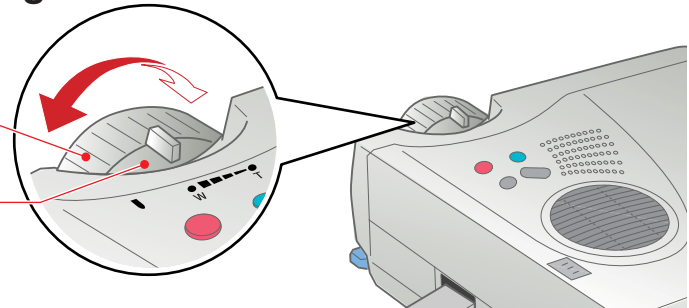

● Automatically adjusting computer images to the optimum settings

Press  on the remote control to automatically adjust the tracking and the display position and synchronization.

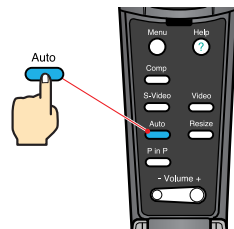

Remote Control

● Other adjustments

Press  on the remote control to display the setting menu on the projection screen. Then adjust the required settings, such as brightness, contrast and sharpness.

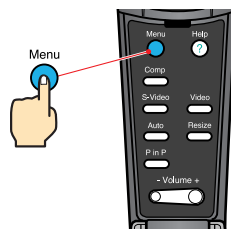

Remote Control

Using the on-screen menus

Main menu

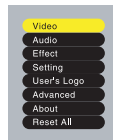

Remote control

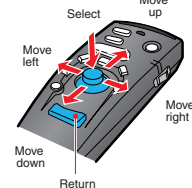

Adjustment



Correcting keystone distortion
Pages 38 of Owner's Manual



Tip

- When keystone correction is carried out, the projected image will become smaller.
- The trapezoid correction state is recorded in memory. Please readjust it when the projection angle is changed.
- If the images become uneven in appearance after keystone correction is carried out, decrease the Sharpness setting.

● If the images have keystone distortion ...

Press  on the projector's control panel to correct the keystone distortion.

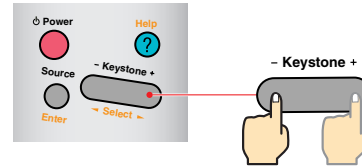

Turning Off the Projector

Pages 29,30 of Owner's Manual

1 Turn off the power for the equipment connected to the projector.

⏻ Power

2 Press the  twice to turn off the projector's power.

 will start flashing orange. (Cool-down in progress)

3 Check that  is lit steadily with an orange color, and then disconnect the power cord.

If the power cord is disconnected while  is still flashing orange, it may cause problems with projector operation.

* Set the R/C switch on the remote control to the OFF position.

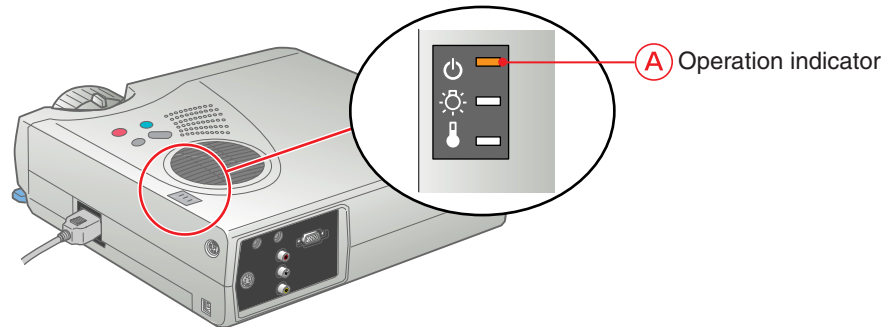

Functions for Enhancing Projection



Tip

● When using the remote control as a wireless mouse, you need to connect the projector as follows.

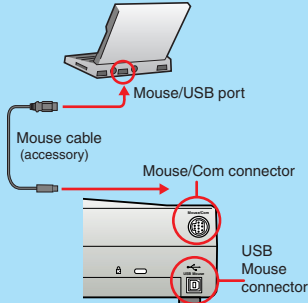

- Use the USB mouse cable if you are connecting to the computer's USB terminal.
- If the mouse function does not work after connecting a PS/2 mouse, you will need to restart the computer.
- Use only the accessory mouse cable provided, otherwise the wireless mouse function may not operate correctly.

This projector is equipped with a variety of useful functions for enhancing projection.

Refer to the corresponding pages of the Owner's Manual for details on each function.

● Using the remote control for one-person presentations

The remote control can be used to carry out the same functions as left-clicking and right-clicking mouse buttons on a computer. You can use the remote control to control the computer's mouse pointer from a distance.

Mouse pointer movement

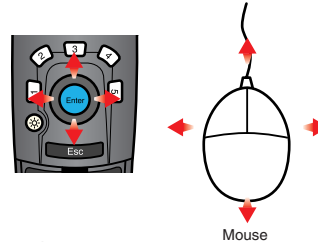

Tilt the  in the direction you want the mouse pointer to go.

Mouse clicks

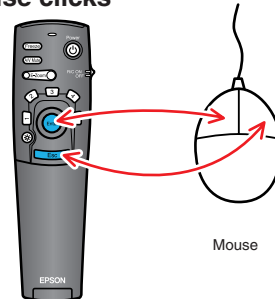

For left clicks: Press 

For right clicks: Press 

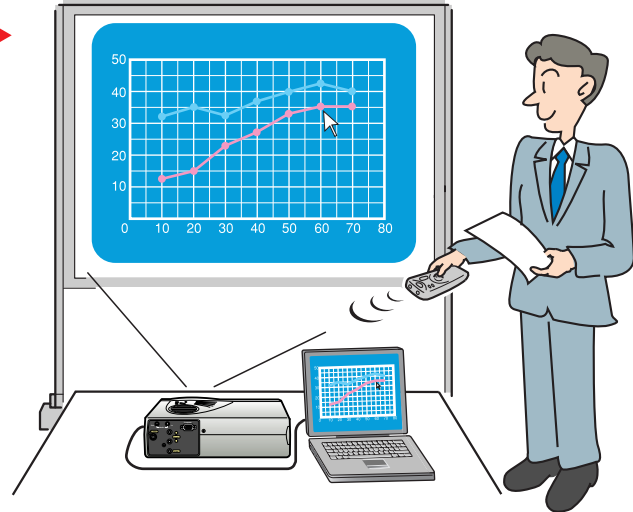



Tip

Press **[5]** to erase the stamps, squares, markers and free lines set for decorative purposes.

Enhancing presentation materials

Press **[1]**.



Displays the pointer icon. Tilt the **[2]** to move the icon, and then press **[3]** to stamp the pointer icon in position.

Press **[2]**.

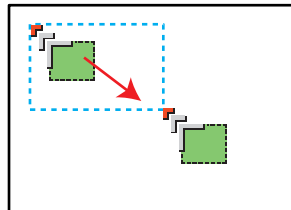

Displays the square icon. Tilt the **[2]** to move the icon to the starting point, and then press **[3]**. Tilt the **[2]** again to move the icon to the ending position, and then press **[3]**.

Press **[3]**.

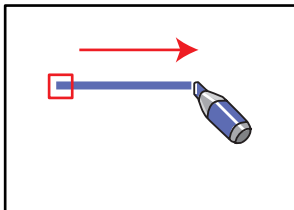

Displays the marker icon. Tilt the **[2]** to move the icon to the starting point, and then press **[3]**. Tilt the **[2]** again to move the icon to the ending position, and then press **[3]**.

Press **[4]**.

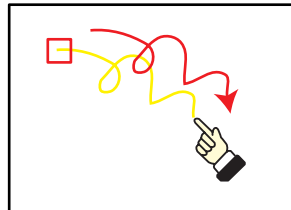



Displays the free line icon. Tilt the **[2]** to move the icon to the starting point, and then press **[3]**. Then tilt the **[2]** in the direction that the line is to be drawn. Press the **[3]** to complete line drawing.



Functions for Enhancing Projection

 E-Zoom function
Page 36 of Owner's Manual

Tip

- After enlarging part of the image, you can tilt the  to scroll around the image.
- To cancel the enlargement effect, press the .

● Enlarging part of projected images

Press  to enlarge the image being projected.

Tilt the  on the remote control to scroll to the area that is to be viewed.

Press .

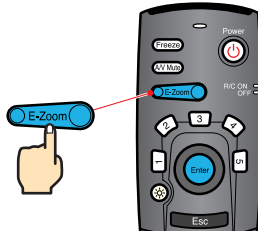

 Press the right side of the button to enlarge the image.

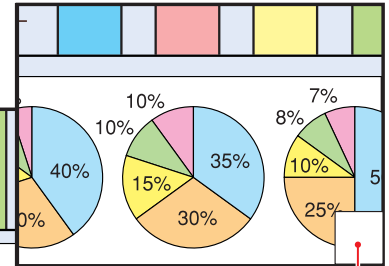
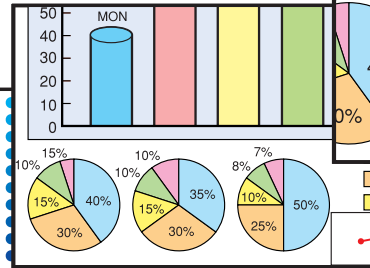
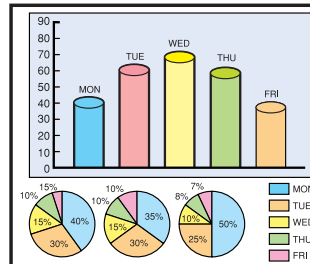

Enlargement ratio



 Press the left side of the button to reduce the size of the enlarged area.



● Momentarily turning off images and sound

The A/V Mute function momentarily pauses the image and sound, and displays either a blank blue or black screen or the user's logo screen. It can be used when you do not want to show viewers details of operations such as selecting different files when computer images are being projected.

Press **A/V Mute** .

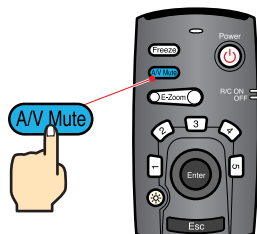

Menu

First press the  , select "Settings" and then "A/V Mute". Then select the type of screen to be displayed when projection is being stopped. The following choices are available. The default setting is the black screen.







Press **A/V Mute** once more.

Projection of the images and sound will be restarted.

If you use this function while projecting moving images, the images and sound will still continue to be played back, and you cannot return to the point where the A/V Mute function was activated.

● Viewing the Online Help

This projector is provided with an online help function which can be used when you have a problem using the projector.



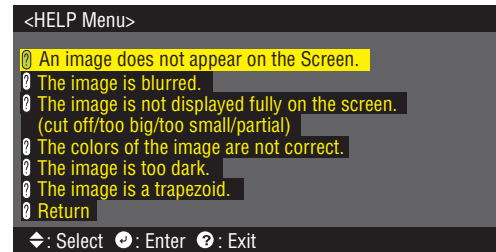
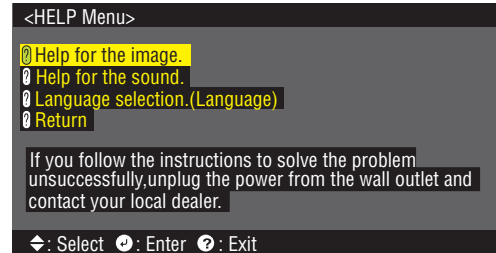
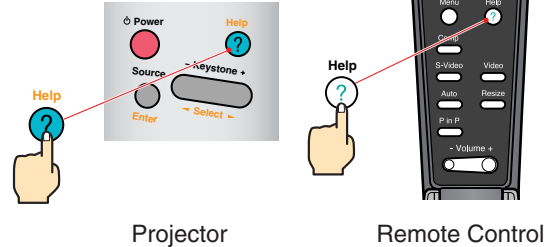



- 1 Press  .**
- 2 Select the item to view.**
Press the  on the projector's control panel.
Or tilt the  on the remote control.
- 3 Accept the selected item.**
Press the  on the projector's control panel.
Or press the  on the remote control.
- 4 The selected item will appear on the screen.**

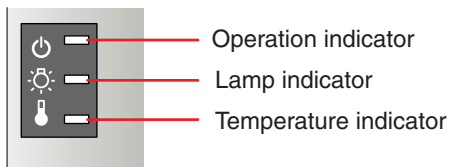







Checking the Indicators

The projector is equipped with indicators that alert you to problems with projector operation. The following tables show what the indicators mean and how to remedy problems that they indicate.



Operation Indicator	
Indicator status	Problem and remedy
Illuminated in Orange 	Standby condition Projection starts when the  is pressed.
Blinking in Orange 	Cool-down in progress After while, the projector switches to the standby condition (the indicator lights orange).
Illuminated in Green 	Projecting in progress
Blinking in Green 	Warm-up in progress After warm-up is complete, projection will start when a video signal is input.
Blinking in Red 	Internal problem Stop using the projector and ask for projector to be repaired. *1
Extinguished	The power is not switched on

Lamp Indicator	
Indicator status	Problem and remedy
Blinking in Red 	Lamp error Replace the lamp with a new one. *2
Illuminated in Red 	Time to replace the lamp. Replace the lamp with a new one. *2
Blinking in Orange 	Nearing the time for replacing the lamp Prepare a new lamp. *2
Extinguished	The power has not been switched on or normal projection is in progress.

Temperature Indicator	
Indicator status	Problem and remedy
Illuminated in Red 	Excessive internal temperature (overheating) The lamp goes off automatically and projection becomes impossible. Wait for approximately 5 minutes with the projector in that state. After 5 minutes has passed, pull out the power plug once, then insert it again. When the power plug is reinserted, the projector will recover to the normal state, so press the  and turn on the power again.
Blinking in Red 	Internal problem Stop using the projector and ask for projector to be repaired. *1
Blinking in Orange 	High-speed cooling in progress. If the internal temperature rises any higher, projection will stop. Check that the air inlet and exhaust vents are clear and that the indoor temperature is not too high.
Extinguished	The power has not been switched on or normal projection is in progress.

*1 If an indicator is showing a status which does not appear in the previous tables, contact your dealer or nearest address provided at "International Warranty Conditions" in "Safety Instructions/World-Wide Warranty Terms" included in the package.

*2 Contact your dealer for a spare lamp.

EPSON®



Printed on 100% recycled paper.



Printed in Japan
90018701
01.09-2B(C01)