

EPSON

SC-P9500 Series
SC-P7500 Series

User's Guide

Copyrights and Trademarks

Copyrights and Trademarks

No part of this publication may be reproduced, stored in a retrieval system, or transmitted in any form or by any means, electronic, mechanical, photocopying, recording, or otherwise, without the prior written permission of Seiko Epson Corporation. The information contained herein is designed only for use with this Epson printer. Epson is not responsible for any use of this information as applied to other printers.

Neither Seiko Epson Corporation nor its affiliates shall be liable to the purchaser of this product or third parties for damages, losses, costs, or expenses incurred by the purchaser or third parties as a result of accident, misuse, or abuse of this product or unauthorized modifications, repairs, or alterations to this product, or (excluding the U.S.) failure to strictly comply with Seiko Epson Corporation's operating and maintenance instructions.

Seiko Epson Corporation shall not be liable for any damages or problems arising from the use of any options or any consumable products other than those designated as Original Epson Products or Epson Approved Products by Seiko Epson Corporation.

Seiko Epson Corporation shall not be held liable for any damage resulting from electromagnetic interference that occurs from the use of any interface cables other than those designated as Epson Approved Products by Seiko Epson Corporation.

Microsoft®, Windows®, Windows Server® and Windows Vista® are registered trademarks of Microsoft Corporation.

Mac, OS X, Bonjour, ColorSync, and Safari are trademarks of Apple Inc., registered in the U.S. and other countries.

Intel® is a registered trademark of Intel Corporation.

Adobe, Adobe RGB, Lightroom, Photoshop, Photoshop Elements, PostScript, and Reader are either registered trademarks or trademarks of Adobe in the United States and/or other countries.

PANTONE®, Colors generated may not match PANTONE-identified standards. Consult current PANTONE Publications for accurate color. PANTONE®, and other Pantone trademarks are the property of Pantone LLC. Pantone LLC, 2019.

ICC profiles made by X-Rite solutions are included.

General Notice: Other product names used herein are for identification purposes only and may be trademarks of their respective owners. Epson disclaims any and all rights in those marks.

© 2019 Seiko Epson Corporation.

Contents

Copyrights and Trademarks

Notes on Manuals

Meaning of Symbols.	6
Illustrations.	6
Product Model Descriptions.	6
Screenshots Used in this Guide.	6
Printer Parts.	7
Front.	7
Inside.	8
Back.	9
Control panel.	11
Home screen operations.	11
Features.	12
Realizing High Resolution.	12
Notes on Usage and Storage.	13
Installation space.	13
Notes when using the printer.	13
Notes when not using the printer.	14
Notes on handling ink cartridges.	14
Notes on handling paper.	15

Introducing the Software

Provided Software.	17
Built-in Software in the Printer.	18
Using Epson Media Installer.	19
Starting.	19
Configuration of the Main Screen.	20
Edit Media Settings Screen Configuration.	22
Adding Paper Information.	25
Editing Paper Information.	25
Sharing Paper Information Across Multiple Computers.	25
Using Web Config.	26
Starting.	26
Closing.	26
Function Summary.	27
Updating Software or Installing Additional Software.	27
Checking Whether Updates are Available and Updating Software.	27
Receiving Update Notifications.	28
Uninstalling Software.	28
Windows.	28

Mac.	29
--------------	----

Basic Operations

Loading and Removing the Roll Paper.	30
Loading Roll Paper.	30
Cutting the roll paper.	33
Removing Roll Paper.	35
Loading and Removing Cut Sheets/Poster Board.	37
Loading Cut Sheets and Poster Board.	37
Removing Cut Sheets/Poster Board.	38
Setting Loaded Paper.	38
How to Set.	38
When there is no paper information on the control panel or in the driver.	39
Using the Paper Basket.	44
Loading and Storing for Front Ejecting.	44
Using the Auto Take-up Reel Unit (SC-P9500 Series Only).	48
Using the Control Panel.	48
Attaching the Roll Core.	49
Attaching the Paper.	49
Removing Paper from the Auto Take-up Reel Unit.	51
Basic Printing Methods.	53
Printing (Windows).	53
Performing Printing (Mac).	54
Canceling Printing (Windows).	56
Canceling Printing (Mac).	57
Canceling Printing (from the Printer).	57
Printable area.	58
Roll Paper Printable Area.	58
Cut Sheets Printable Area.	59
Turning Off the Power Using Power Off Timer.	60
Saving Power.	60

Using the Optional Hard Disk Unit

Function Summary.	61
Extended functions.	61
Print Job Management.	61
Data on a Hard Disk.	61
Saving Print Jobs.	62
Viewing and Printing Saved Print Jobs.	63

Contents

Using the Printer Driver(Windows)

Displaying the Settings Screen. 64
 With the Start button. 64
 Displaying Help. 65
 Click the Help Button to Display. 65
 Right-click on the item you want to check
 and display. 65
 Customizing the Printer Driver. 66
 Saving various settings as your Select Settings. . . 66
 Adjusting the Ink Density. 66
 Rearranging display items. 67
 Summary of the Utility Tab. 69

Using the Printer Driver (Mac)

Displaying the Settings Screen. 71
 Displaying Help. 71
 Using Presets. 71
 Saving to Presets. 71
 Deleting from Presets. 72
 Using Epson Printer Utility 4. 72
 Starting Epson Printer Utility 4. 72
 Epson Printer Utility 4 Functions. 72

Printing Varieties

Printing with Darker Tones of Black (Black
 Enhance Overcoat). 74
 Correct color and print. 74
 Printing Black and White Photos. 78
 Borderless Printing. 81
 Types of Borderless Printing Methods. 81
 Supported Paper. 81
 About Roll Paper Cutting. 82
 Setting Procedures for Printing. 83
 Enlarged/Reduced Printing. 85
 Fit to Page/Scale to fit paper size. 86
 Fit to Roll Paper Width(Windows Only). 87
 Custom Scale Setting. 88
 Multi-Page Printing. 90
 Poster Printing (Enlarge to cover several sheets
 and print - Windows only). 91
 Setting Procedures for Printing. 92
 Joining the output paper together. 93
 Printing at Non-Standard Sizes. 97
 Banner printing (on roll paper). 99
 Layout Manager(Windows Only). 101
 Setting Procedures for Printing. 101

Saving and Recalling Settings. 103

Color Management Printing

About Color Management. 104
 Color Management Print Settings. 104
 Setting profiles. 105
 Setting color management with the applications. . 105
 Setting color management with the printer driver. 107
 Color management printing by Host ICM
 (Windows). 107
 Color Management Printing by ColorSync
 (Mac). 108
 Color management printing by Driver
 ICM(Windows Only). 108

Menu List

Paper Setting. 111
 General Settings. 116
 Supply Status. 122
 Maintenance. 123
 Language. 123
 Status. 124

Maintenance

Print Head Maintenance. 125
 Maintenance Operations. 125
 Print Head Nozzle Check. 125
 Cleaning the print head. 127
 Print Head Alignment. 129
 Paper Feed Adjust. 132
 Replacing Consumables. 133
 Replacing Ink Cartridges. 133
 Replacing Maintenance Box. 134
 Replacing the Cutter. 135
 Cleaning the Printer. 137
 Cleaning the outside. 137
 Cleaning the inside. 137

Problem Solver

What to do When a Message is Displayed. 139
 SpectroProofer Error. 140
 When an Error Message and Error Code are
 Displayed. 141
 Troubleshooting. 142
 You cannot print (because the printer does
 not work). 142

Contents

The printer sounds like it is printing, but nothing prints.	144
The prints are not what you expected.	144
Feeding or ejecting problems.	157
Others.	160

Appendix

Options and Consumable Products.	163
Epson Special Media.	163
Ink cartridges.	163
Others.	165
Absorption pad replacement kit (absorption pads for borderless printing).	166
Supported Media.	168
Epson Special Media Table.	168
Supported Commercially Available Paper.	179
Before Printing on Commercially Available Paper.	180
PANTONE Color Explanation.	182
Notes When Moving or Transporting the Printer.	182
Notes When Moving the Printer.	182
Notes on Transporting.	183
Notes when reusing the printer.	184
System Requirements.	185
Printer Driver.	185
Web Config.	186
Epson Edge Dashboard.	187
Specifications Table.	188

Where To Get Help

Technical Support Web Site.	190
Contacting Epson Support.	190
Before Contacting Epson.	190
Help for Users in North America.	191
Help for Users in Europe.	191
Help for Users in Taiwan.	191
Help for Users in Australia/New Zealand.	192
Help for Users in Singapore.	192
Help for Users in Thailand.	193
Help for Users in Vietnam.	193
Help for Users in Indonesia.	193
Help for Users in Hong Kong.	194
Help for Users in Malaysia.	194
Help for Users in India.	194
Help for Users in the Philippines.	195

Notes on Manuals

Meaning of Symbols

 Warning:	Warnings must be followed to avoid serious bodily injury.
---	---

 Caution:	Cautions must be followed to avoid bodily injury.
---	---

 Important:	Important must be followed to avoid damage to this product.
---	---

Note:	Notes contain useful or additional information on the operation of this product.
--------------	--

	Indicates related reference content.
---	--------------------------------------

Illustrations

The illustrations may differ slightly from the model you are using. Please be aware of this when using the manuals.

Product Model Descriptions

Some models described in this manual may not be sold in your country or region.

Screenshots Used in this Guide

- ❑ Screenshots used in this guide may differ slightly from the actual screens. Also, screens may differ depending on the operating system or the usage environment.
- ❑ Unless otherwise specified, the Windows screenshots used in this guide are of Windows 10.
- ❑ Unless otherwise specified, the Mac OS X screenshots used in this guide are of Windows Mac OS X v 10.8.x.

Printer Parts

Front

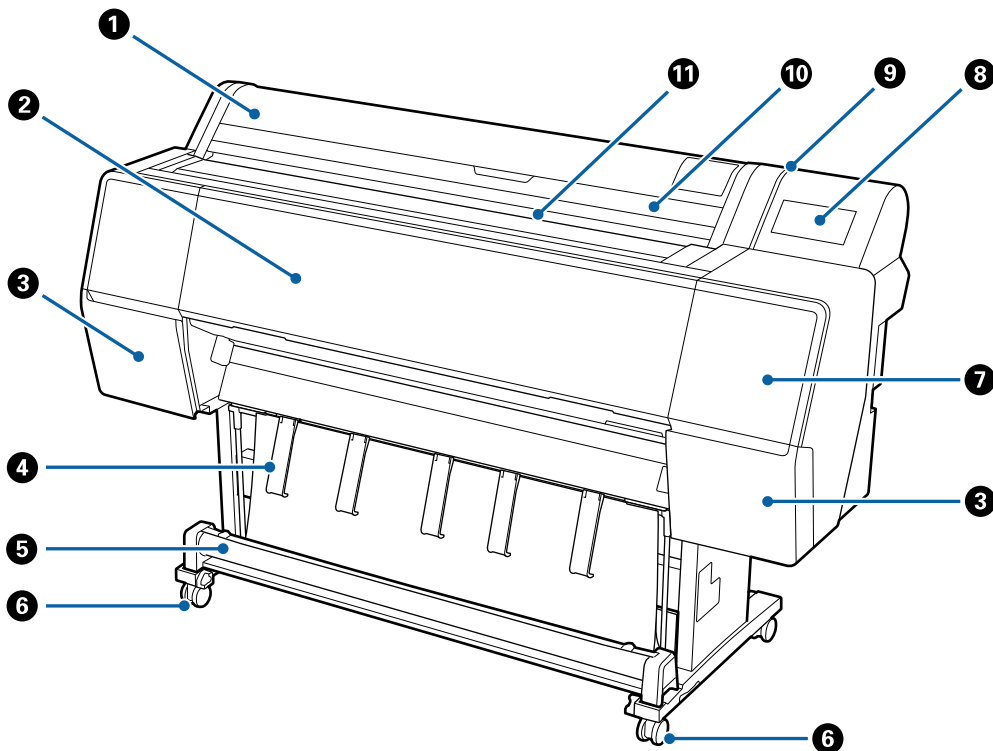

1 Roll paper cover

Open to load roll paper.

2 Front cover

Open this cover when cleaning the printer or clearing jams.

3 Cartridge covers (on the left and right)

Open when installing ink cartridges.

 [“Replacing Ink Cartridges” on page 133](#)

4 Paper support

Use this to adjust the direction of the output paper.

5 Paper basket

Output from the printer collects in this basket, keeping the media clean and free of creases.

 [“Using the Paper Basket” on page 44](#)

Notes on Manuals

6 Casters

There are two casters on each leg. The casters are normally kept locked once the printer is in place.

7 Maintenance cover (front)

Open when cleaning around the caps.

 [“Cleaning around the print head and caps” on page 148](#)

8 Control panel

 [“Control panel” on page 11](#)

9 Alert Lamp

Turns on when an error has occurred. You can check the contents of the error on the control panel.

10 Cut sheet cover

Open when loading cut sheets or poster board.

11 Paper slot

Insert the paper into this slot.

Inside

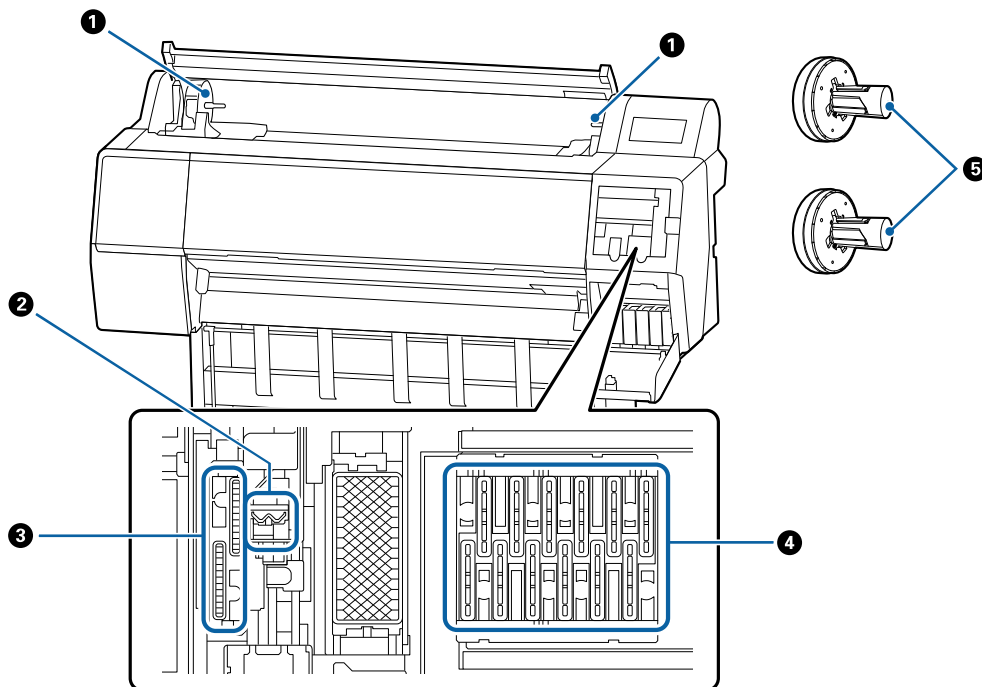

1 Adapter holder

The roll paper adapter is placed in this holder when loading the roll paper.

Notes on Manuals

2 Wipers

Wipe off ink from the nozzle surface of the print head. Try cleaning these when automatic cleaning does not clear clogging in the print head.

 [“Cleaning around the print head and caps” on page 148](#)

3 Suction caps

During head cleaning, this cap sucks the optimum amount of ink from the print head nozzles. Try cleaning these when automatic cleaning does not clear clogging in the print head.

 [“Cleaning around the print head and caps” on page 148](#)

4 Drying prevention caps

Except when printing, these caps cover the print head nozzles to prevent them from drying. Try cleaning these when automatic cleaning does not clear clogging in the print head.

 [“Cleaning around the print head and caps” on page 148](#)

5 Roll paper adapter

When loading roll paper into the printer, insert this through the roll paper.

Back

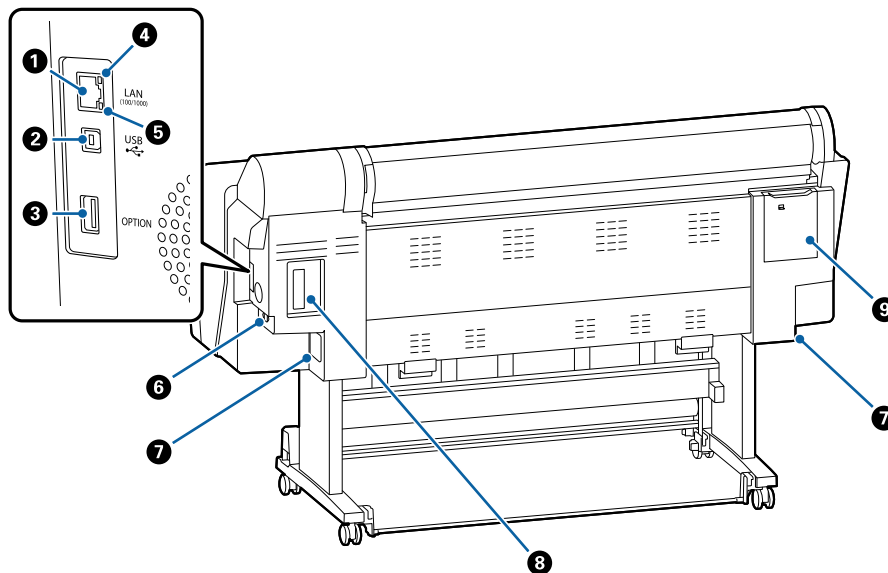

1 LAN port

Connects the LAN cable.

2 USB port

Connects the USB cable.

Notes on Manuals

3 Option port

Connects the optional SpectroProofer mounter or Auto Take-up Reel Unit (for the SC-P9500 Series only).

4 Status light

The color indicates the network transmission speed.

Off : 10Base-T

Red : 100Base-TX

Green : 1000Base-T

5 Data light

The network connection status and data reception are indicated by a lit or flashing light.

On : Connected.

Flashing : Receiving data.

6 AC inlet

Connect the supplied power cable here.

7 Maintenance Box

Absorbs waste ink. For SC-P9500 Series, this is placed in two locations on the left and right, while SC-P7500 Series is in one location on the right.

 [“Replacing Maintenance Box” on page 134](#)

8 Option slot

Slot for installing the optional Adobe® PostScript® 3™ expansion unit or hard disk unit.

9 Maintenance cover (rear)

Open when cleaning around the print head.

 [“Cleaning around the print head and caps” on page 148](#)

Notes on Manuals

Control panel

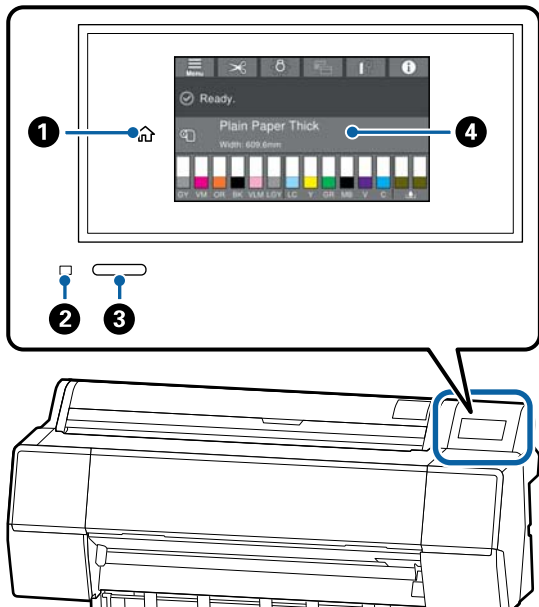

- 1 Home button**
 Touch this button while a menu is displayed to return to the Home screen.
 The home button is off when it cannot be used during operations such as paper feeding.
- 2 Power lamp**
 On : The power is on.
 Flashing : The printer is performing a process such as starting up, powering off, data receiving, or print head cleaning. Please wait without performing any operation until this light stops flashing. Do not disconnect the power cord.
 Off : The power is off.
- 3 Power button**
- 4 Control panel**
 This is a touch panel to display the printer's status, menus, error messages, and so on.

Home screen operations

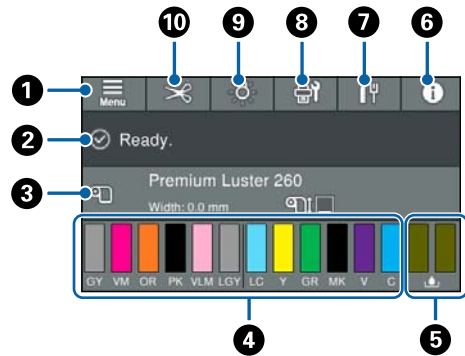

- 1 Menu**
 Allows you to make paper settings, printer settings, and perform printer maintenance. See the following for a list of the menus.
 ⓘ “Paper Setting” on page 111
- 2 Information display area**
 Displays the printer's status, error messages, and so on.
- 3 Paper loading information**
 Displays paper information for the loaded paper.
- 4 Display ink levels**
 Displays the amount of ink remaining in the ink cartridges. When the ⚠ symbol is displayed, the ink cartridge is running low. Press the display to check the cartridge model number.
- 5 Displays amount of space remaining in the maintenance box**
 Displays the approximate amount of space in the maintenance box. When the ⚠ symbol is displayed, the maintenance box is nearly full. Press the display to check the maintenance box model number.
- 6 Information**
 You can check the status of the printer by viewing consumable information and the list of messages. You can also check the job history.
- 7 Internet connection status**

Notes on Manuals

You can check the status of the wired LAN connection and change settings.

- 8 Maintenance/Switching screens while printing**
 A shortcut to the maintenance menu is displayed while standing by. You can check and clean the print head nozzles, replace consumables, and clean parts.
 The screen switching menu is displayed during printing. You can switch between Professional display, which shows the remaining amount of ink and so on, and Simple display, which shows the print completion time.
- 9 Internal lighting**
 You can turn the internal lighting on or off. Turn on the internal light when you want to check the print as it is being printed.
- 10 Feed/Cut Paper**
 When roll paper is loaded, you can perform paper feed adjustments, cut the paper, and make cutting settings.

Features

The main features of this printer are described below.

Realizing High Resolution

The newly developed ink technology provides high definition for photo, fine art, and proofing paper.

New print head design

Our new print heads are equipped with a 2.64 inch integrated precision core μ TFP head with a staggered array, and we have adopted a resolution of 300 dpi for optimal printing.

Pigmented inks with superior resistance

Pigment inks maintain more beautiful and more vibrant prints over a long period of time with their high light fastness. They are also extremely fade-resistant and can be safely displayed in direct sunlight. Additionally, the high water and ozone resistance is not only ideal for photo printing, but also allows for store displays and banners, outdoor displays of posters and so on. When you are printing for outdoor use, use lamination processing.

A variety of black and color inks

As well as the five basic ink colors, inks with the following features have also been included.

Two types of black ink to suit your printing purposes

By automatically switching to suit the paper type being used, the two types of black ink provided are Photo Black which realizes a smooth, professional finish on glossy paper, and Matte Black which increases black optical density using matte paper.

Two types of gray ink to improve gradation

In addition to Photo Black and Matte Black, two additional variants of black ink have also been installed (Gray and Light Gray) to provide excellent granularity and richly expressive gradation.

Notes on Manuals

Three spot color inks that help to realize a wide range of color reproduction

This printer is equipped with Orange, Green, and Violet inks allowing us to realize a wide range of color reproduction, thereby achieving high PANTONE coverage.

Notes on Usage and Storage

Installation space

Make sure that you secure a space of at least 300 mm around the entire printer, clear of any other objects, so that paper ejection and consumable replacement are not obstructed.

See the "Specifications Table" for the external dimensions of the printer.

 ["Specifications Table" on page 188](#)

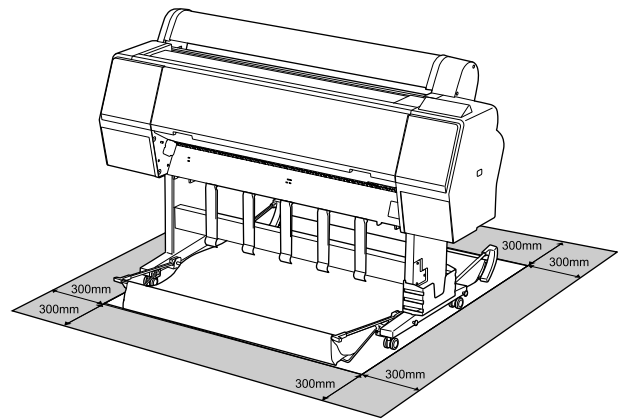

Notes when using the printer

Note the following points when using this printer to avoid breakdowns, malfunctions, and print quality decline.

- ❑ When using the printer, observe the operating temperature and humidity range described in the "Specifications Table".

 ["Specifications Table" on page 188](#)

Even when the conditions above are met, you may not be able to print properly if the environmental conditions are not suitable for the paper. Be sure to use the printer in an environment where the paper's requirements are met. For more details, see the documentation supplied with the paper. Also, when operating in dry areas, air conditioned environment, or under direct sunlight, maintain the appropriate humidity.

Notes on Manuals

- ❑ Do not install the printer next to heat sources or directly in the path of air from a ventilator or air conditioner. Failure to observe this precaution could result in the print head nozzles drying and clogging.
- ❑ The print head may not be capped (i.e., may not move to the right-hand side) if an error occurs and the printer is turned off without first resolving the error. Capping is a function for automatically covering the print head with a cap (lid) to prevent the print head from drying out. In this case, turn on the power and wait a while until capping is performed automatically.
- ❑ When the power is on, do not remove the power plug or cut the power at the breaker. The print head may not be capped properly. In this case, turn on the power and wait a while until capping is performed automatically.
- ❑ Even when the printer is not in use, some ink will be consumed by head cleaning and other maintenance operations needed to keep the print head in good condition.

Notes when not using the printer

If you are not using it, note the following points when storing the printer. If it is not stored correctly, you may not be able to print properly the next time it is used.

- ❑ If you do not print for a long time, the print head nozzles may become clogged. We recommend that you print once a week to prevent the print head from clogging.
- ❑ The roller may leave an impression on paper that is left in the printer. This can also cause wavy or curled paper resulting in paper feeding problems or the print head could be scratched. Remove any paper when storing.
- ❑ Store the printer after confirming that the print head has been capped (the print head is positioned at the far right). If the print head is left uncapped for a long time, the print quality may decline.

Note:

If the print head is not capped, turn the printer on, and then turn it off.

- ❑ To prevent the accumulation of dust and other foreign matter in the printer, close all covers before placing it in storage.
If the printer will be not be used for an extended period, protect it with an anti-static cloth or other cover.
The print head nozzles are very small, and they can become clogged easily if fine dust gets on the print head, and you may not be able to print properly.
- ❑ When turned on after an extended period of disuse, the printer may automatically perform head cleaning to ensure print quality.
 [“Print Head Maintenance” on page 125](#)

Notes on handling ink cartridges

Note the following points when handling ink cartridges to maintain good print quality.

- ❑ The supplied ink cartridges and Maintenance Box are for use during the initial charging. The supplied ink cartridges and Maintenance Box will be required replacement relatively quickly.
- ❑ We recommend that ink cartridges be stored at room temperature out of direct sunlight and used before the expiry date printed on the packaging.
- ❑ To ensure good results, we recommend that all the ink in the cartridge be used within a year of installation.
- ❑ Ink cartridges that have been stored at low temperatures for an extended period should be allowed to return to room temperature over a period of four hours.
- ❑ Do not touch the IC chips on the ink cartridges. You may not be able to print properly.
- ❑ Install all ink cartridges into each slot. You cannot print if any of the slots are empty.
- ❑ Do not leave the printer without ink cartridges installed. The ink in the printer may dry, preventing it from printing as expected. Leave ink cartridges in all slots even while you do not use the printer.

Notes on Manuals

- ❑ The ink level and other data are stored in the IC chip, allowing cartridges to be used after being removed and replaced.
- ❑ To avoid getting dirt on the ink supply port, store the removed ink cartridge properly. The ink supply port has a valve in it so it does not need to be capped.
- ❑ Removed ink cartridges may have ink around the ink supply port, so be careful not to get any ink on the surrounding area when removing the cartridges.
- ❑ To maintain the quality of the print head, this printer stops printing before ink cartridges are completely expended, and ink remains in the used cartridge.
- ❑ Although the ink cartridges may contain recycled materials, this does not affect printer function or performance.
- ❑ Do not dismantle or remodel ink cartridges. You may not be able to print properly.
- ❑ Do not drop or knock ink cartridges against hard objects; otherwise, the ink may leak.

Notes on handling paper

Note the following points when handling and storing the paper. If the paper is not in good condition, print quality may decline.

Check the documentation supplied with each paper.

Notes on Handling

- ❑ Use Epson special media under normal room conditions (temperature: 15 to 25°C, humidity: 40 to 60%).
- ❑ Do not fold the paper or scratch the surface of the paper.
- ❑ Avoid touching the printable surface of the paper with your bare hands. Moisture and oils from your hands can affect print quality.
- ❑ Handle paper by the edges. We recommend wearing cotton gloves.

- ❑ Changes in temperature and humidity may cause paper to become wavy or curled. Check the following points.
 - ❑ Insert the paper just before printing.
 - ❑ Do not use wavy or warped paper. For roll paper, cut off any parts that are wavy or curled, and then load the paper again. For cut sheets, use new paper.
- ❑ Do not wet the paper.
- ❑ Do not throw away the paper packaging as you can use it for storing the paper.
- ❑ Avoid locations that are subject to direct sunlight, excessive heat, or humidity.
- ❑ Keep cut sheets in their original package after opening, and keep them in a flat place.
- ❑ Remove roll paper that is not in use from the printer. Rewind it correctly and then store it in the original packaging that came with the roll paper. If you leave the roll paper in the printer for a long time, its quality may decline.

Notes on handling printed paper

To maintain long lasting, high quality print results, note the following points.

- ❑ Do not rub or scratch the printed surface. If they are rubbed or scratched, the ink may peel off.
- ❑ Do not touch the printed surface; Failure to observe this precaution may cause ink to rub off.
- ❑ Make sure the print outs are completely dry before folding or stacking; otherwise, the color may change where they touch (leaves a mark). These marks will disappear if they are separated immediately and dried; however, they will remain if not separated.
- ❑ If you put the print outs in an album before they are completely dry, they may be blurred.
- ❑ Do not use a dryer to dry the print outs.
- ❑ Avoid direct sunlight.

Notes on Manuals

- ❑ Prevent color distortion while displaying or storing the print outs by following the instructions in the paper's documentation.

Note:

Typically, print outs and photos fade over time (color distortion) due to the effects of light and various constituents in the air. This also applies to Epson special media. However, with the correct storage method, the degree of color distortion can be minimized.

- ❑ *See the documentation supplied with Epson special media for detailed information on handling the paper after printing.*
- ❑ *The colors of photos, posters, and other printed materials appear different under different lighting conditions (light sources^{*}). The colors of print outs from this printer may also appear different under different light sources.*

** Light sources include sunlight, fluorescent light, incandescent light, and other types.*

Introducing the Software

Introducing the Software

Provided Software

The following table lists the provided software.



The supplied software disc contains the software for Windows. When using a Mac or a computer without a disc drive, download the software from <http://epson.sn> and then install it.

For details on the various software, see the online help of each software or the *Administrator's Guide* (online manual).

Note:

Convenient software compatible with this printer is introduced on the Epson website. Please check the information from the following link.

<http://www.epson.com>

Software Name	Function
Printer Driver	Install the printer driver to take full advantage of the functionality of this printer when printing.
EPSON Software Updater	Software to check whether there is any software update information and then notify you and install the software if an update is available. It allows you to update the firmware and already installed software of the printer.  "Updating Software or Installing Additional Software" on page 27
EpsonNet Config*	This software allows you to perform network initialization or setting changes as a batch. EpsonNet Config is not installed automatically. Download it from the Epson website and then install it if necessary. http://www.epson.com For Windows, you can install the software from the following folder on the supplied software disc. //Network/EpsonNetConfig  <i>Administrator's Guide</i>
Epson Edge Dashboard*	Convenient software for administrating multiple printers. This enables confirmation in a list of the status of printers registered for monitoring.
Epson Media Installer	This tool adds paper information to a printer or printer driver. If you are using Windows, you can start it from the printer driver. If you are using a Mac, you can start it from the /Applications/Epson Software/Epson Utilities/Epson Media Installer.app. Instructions  "Using Epson Media Installer" on page 19
Epson Print Layout*	This is a plug-in software for Adobe Photoshop, Adobe Lightroom, Nikon ViewNX-i, and SILKYPIX. It provides a number of useful features such as pre-print previews or layouts allowing you to easily print re-touched or processed photos.

*Download software from the Internet, and install. Connect the computer to the Internet and install.

Introducing the Software

Built-in Software in the Printer

The following software comes preinstalled in the printer. Start and use it from a Web browser via the network.

Software Name	Function
Web Config	The network security settings can be configured from Web Config. This software also has an email notification function for notifying of printer errors and other problems. 👉 "Using Web Config" on page 26

Introducing the Software

Using Epson Media Installer

This section provides an overview of the Epson Media Installer functions and basic procedures.

Epson Media Installer allows you to add paper information over the Internet. You can also edit the paper information you have added.

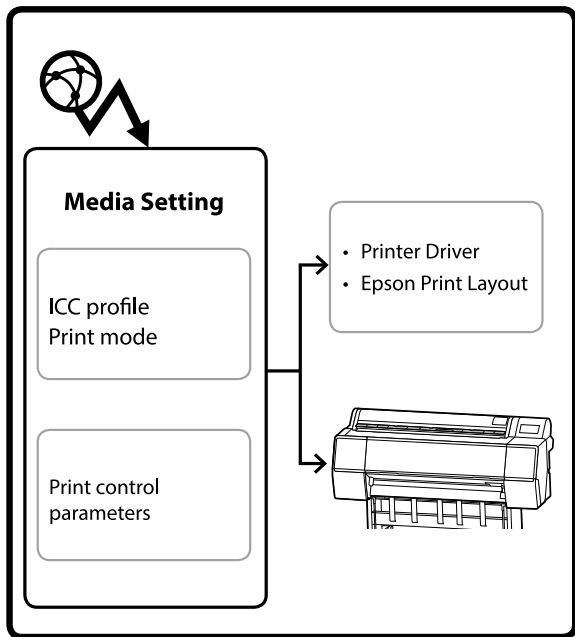

Paper information, including ICC profiles, print modes, and print control parameters, is downloaded from servers. Downloaded paper information is saved in the printer driver, Epson Print Layout, or the printer.

Starting

You need to download Epson Media Installer from the printer's Epson support page and install it.

See the following for more details.

[📄 “Introducing the Software” on page 17](#)

Use one of the following methods to start Epson Media Installer.

For Windows

Click in the following order.

Start - Epson Software - Epson Media Installer

For Mac

Click in the following order.

Applications - Epson Software - Epson Utilities - Epson Media Installer.app

Epson Edge Dashboard



Printer Driver (Windows)

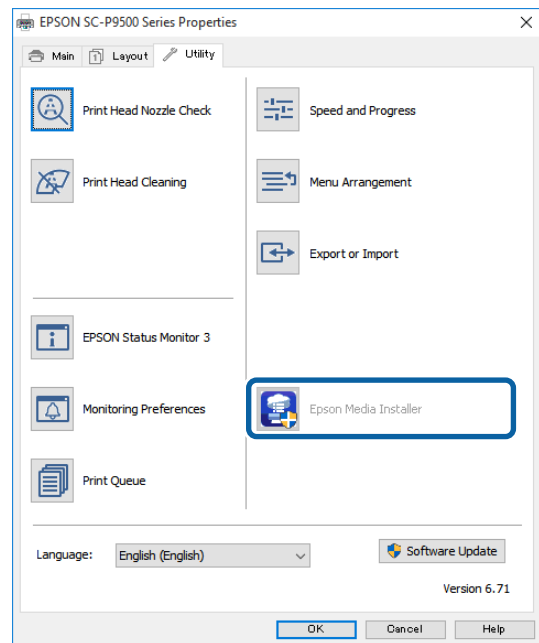

Download the latest printer driver from the Epson Website.

Introducing the Software

Configuration of the Main Screen

When you start Epson Media Installer, one of the following screens is displayed. Click the screen name at the top of the screen to switch between screens.

- ❑ Media Management screen
- ❑ Media Download screen

The following shows the configuration and functions of each screen.

Media Management screen

Displays the paper information saved in the selected printer.

However, paper information set in **Custom Paper Setting** on the printer's control panel is not displayed.

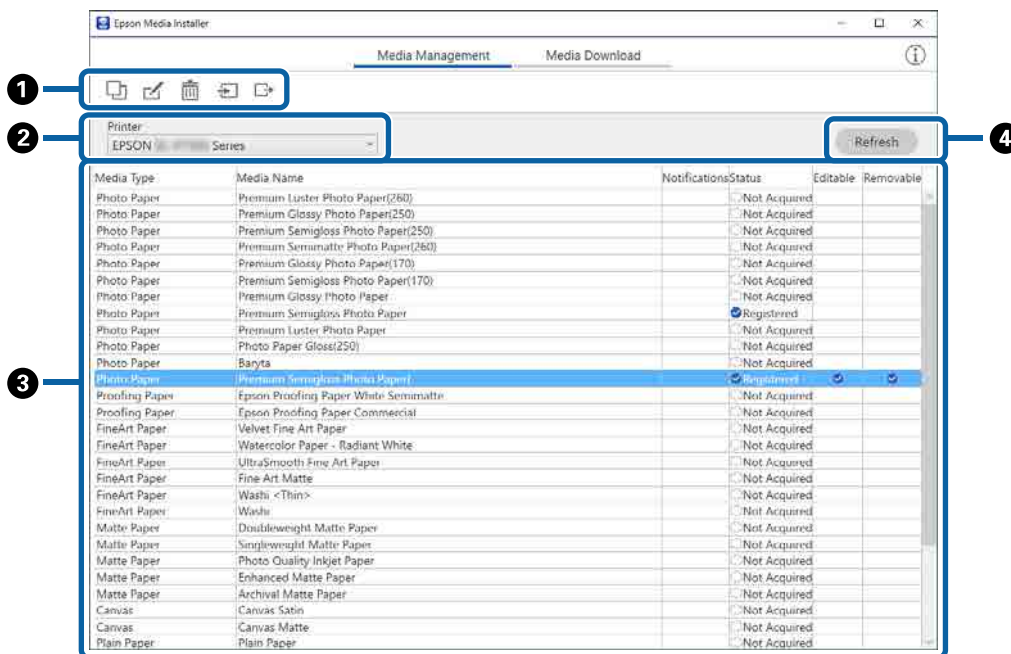

Part Name	Function
<p>1 Media operation area</p>	<p>You can perform the following operations for the paper information selected in the media list (3).</p> <ul style="list-style-type: none"> (Copy Media): Creates a copy of the selected paper information and saves it to the printer, printer driver, or Epson Print Layout. (Edit): Changes the settings for the selected paper information. The Edit Media Settings screen is displayed when you can change the settings. "Edit Media Settings Screen Configuration" on page 22 (Remove): Deletes the selected paper information from the printer, printer driver, or Epson Print Layout. (Import): Imports a paper information file. You can only select and import one file at a time. (Export): Exports the selected paper information to a file. You can only select and export one file at a time.

Introducing the Software

	Part Name	Function
2	Printer	Select the printer for which you want to display the paper information.
3	Media List	<p>Displays a list of the paper information stored on the printer selected in Printer (2).</p> <p>The following explains the content of each column.</p> <ul style="list-style-type: none"> <input type="checkbox"/> Media Type Displays paper information for each media type. The order in which the media types are displayed is the same as on the printer's control panel. <input type="checkbox"/> Media Name Paper information that has been copied using <input type="checkbox"/> (Copy Media) is differentiated by adding the word Copy to the end of the name. <input type="checkbox"/> Notifications When additional information is available,  is displayed. Click it to view the information. <input type="checkbox"/> Status <ul style="list-style-type: none"> <input checked="" type="radio"/> Registered: Paper information is downloaded to Epson Media Installer, and saved to the printer, printer driver, or Epson Print Layout. <input type="radio"/> Not Acquired: Paper information has not been downloaded to Epson Media Installer, but saved to the printer, printer driver, or Epson Print Layout. You can still print on genuine Epson paper, even when the status is Not Acquired. <input type="checkbox"/> Editable <input checked="" type="checkbox"/> is displayed in the paper information for settings that can be changed. <input type="checkbox"/> Removable <input checked="" type="checkbox"/> is displayed for paper information that can be removed.
4	Refresh button	Click this if paper information you added previously is not displayed in the printer driver, in Epson Print Layout, and so on.

Media Download screen

Download the paper information from the server and register it to your printer or printer driver.

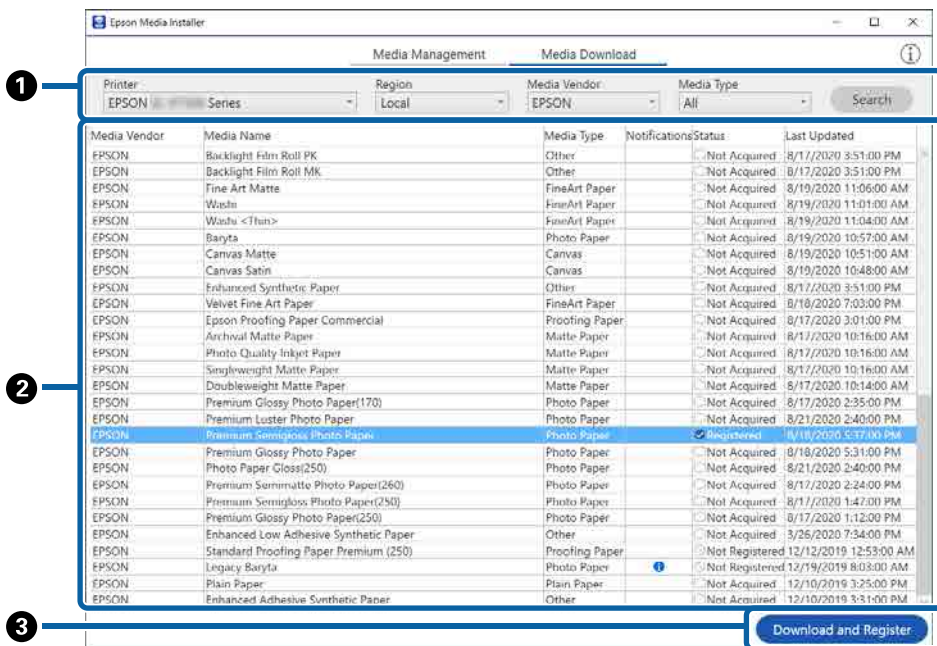

Introducing the Software

	Part Name	Function
①	Search Criteria Area	When you want to narrow down the paper information displayed in the media list (②), specify the search criteria, and then click Search .
②	Media List	<p>Displays paper information that matches the search criteria specified in the Search Criteria Area (①).</p> <p>The following shows the content displayed for Notifications and Status.</p> <ul style="list-style-type: none"> <input type="checkbox"/> Notifications When additional information is available,  is displayed. Click it to view the information. <input type="checkbox"/> Status <ul style="list-style-type: none"> <input checked="" type="checkbox"/> Registered: Paper information is downloaded to Epson Media Installer, and saved to the printer, printer driver, or Epson Print Layout. <input checked="" type="checkbox"/> Update Available: Paper information on the server has been updated. When you download the paper information again, the latest paper information is saved to the printer, the printer driver, or Epson Print Layout. <input type="checkbox"/> Not Registered: Paper information is not saved to the printer, the printer driver, or Epson Print Layout. <input type="checkbox"/> Not Acquired: Paper information has not been downloaded to Epson Media Installer.
③	Download and Register button	Downloads the selected paper information from the server and saves it to the printer, the printer driver, or Epson Print Layout.

Edit Media Settings Screen Configuration

Allows you to change the paper information settings on the Edit Media Settings screen.

Introducing the Software

The following shows the main setting items.

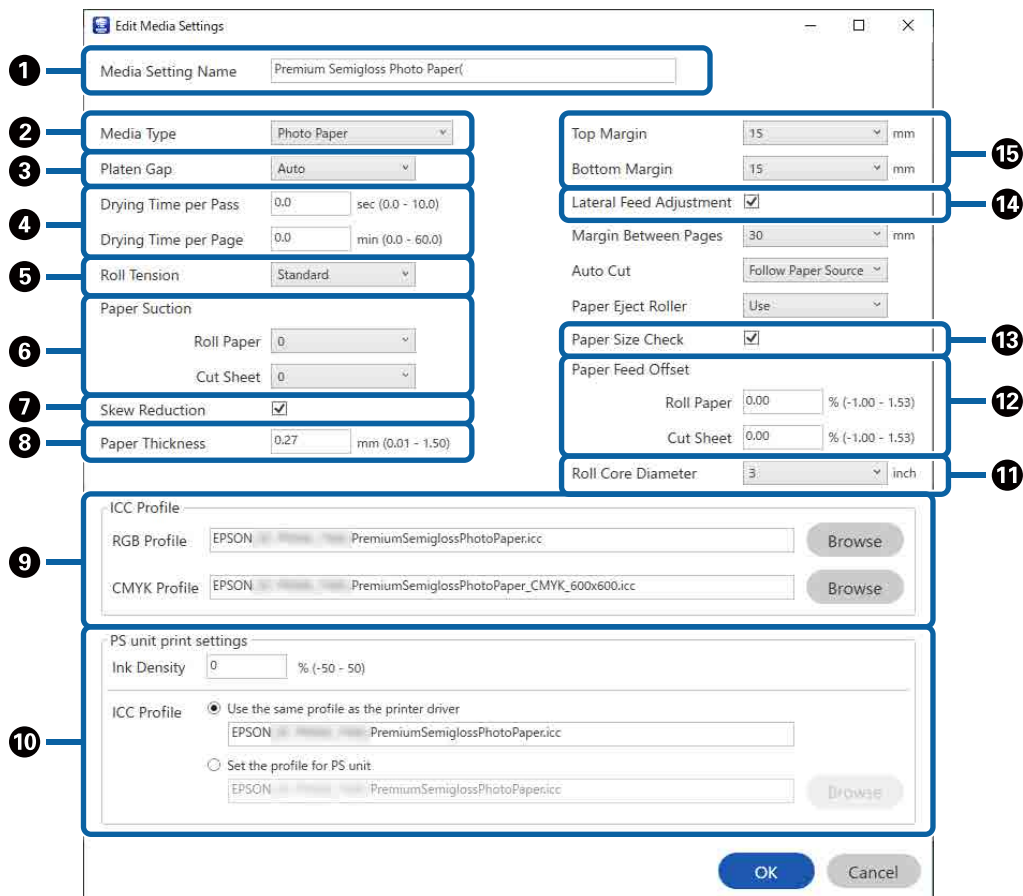

Item	Function
1	Media Setting Name You can change the media name.
2	Media Type You can change the type of paper information. This change is reflected in the printer driver and on the printer's control panel.
3	Platen Gap Select a wider setting if print results are scratched or smudged.
4	Drying Time You can set the drying time for each print head movement (pass) or the drying time for each page.
5	Roll Tension Adjust this when paper gets wrinkled during printing.
6	Paper Suction Thin or soft paper may not be fed correctly. In this situation, set a lower value.
7	Skew Reduction When this is selected, the printer takes measures to reduce feeding the paper at an angle.
8	Paper Thickness Set the thickness of the paper.
9	ICC Profile Click Browse to change the ICC profile. You can set RGB Profile and CMYK Profile . <input type="checkbox"/> Set RGB Profile when printing using the printer driver. <input type="checkbox"/> When printing using RIP software, set the color mode profile supported by your RIP to RGB Profile or CMYK Profile .

Introducing the Software

	Item	Function
10	PS unit print settings	Displayed when the optional Adobe® PostScript® 3™ expansion unit is installed. Sets the print settings for the printer when using the Adobe PostScript 3 expansion unit.
	Ink Density	Sets the ink density for printing by using the PS Folder. When printing from the Adobe PostScript 3 expansion unit without using PS Folder, the ink density set in the PS printer driver is applied. See the following for more details on the PS Folder.  "Adobe® PostScript® 3™ Expansion Unit User's Guide"
	ICC Profile	Sets the ICC profile when printing from the Adobe PostScript 3 expansion unit. Select one of the following. <ul style="list-style-type: none"> <input type="checkbox"/> Use the same profile as the printer driver When printing from the Adobe PostScript 3 expansion unit, the profile set in RGB Profile for ICC Profile (🕒) is used as the ICC profile. If the RGB Profile is blank, you cannot select it, so be sure to set the RGB Profile first. <input type="checkbox"/> Set the profile for PS unit Select to use the CMYK profile as the ICC profile when printing from the Adobe PostScript 3 expansion unit. Click Browse to set the profile.
11	Roll Core Diameter	Set the paper core size for the roll paper being loaded.
12	Paper Feed Offset	Optimizes the paper feed when printing. By adjusting the gap between the data size and the print size, you can reduce the chance of banding (horizontal banding) or uneven colors. Example of entering settings When printing at a data size of 100 mm and a print size of 101 mm, the offset is 1.0%. Therefore, you would enter a value of -1.0%.
13	Paper Size Check	When this is selected, the width of the loaded paper is automatically detected.
14	Lateral Feed Adjustment	Select this to correct the difference between the left and right sides of the paper feed.
15	Margins	If the margin at the leading edge of the paper is small, colors may be uneven depending on the paper and printing environment. If this occurs, print a larger margin at the leading edge of the paper.

See the following for details on setting items other than the above.

 ["Paper Setting" on page 111](#)

Introducing the Software

Adding Paper Information

See the following for details on how to add paper information to the printer or the printer driver using Epson Media Installer.

[“Adding paper information” on page 40](#)

Editing Paper Information

See the following for details on how to edit paper information that has been added.

[“Editing paper information” on page 42](#)

Sharing Paper Information Across Multiple Computers

This section explains how to share paper information that was added/edited using Epson Media Installer between computers when multiple computers are connected to one printer.

For example, connect computer [A] and computer [B] to one printer, and then add/edit paper information using Epson Media Installer on computer [A]. At this time, the added/edited paper information is displayed in Epson Media Installer on computer [B]; however, the added/edited paper information is not displayed in the printer driver for [B]. To display the added/edited paper information in the [B] printer driver, you need to share the paper information between computers.

Sharing added paper information

1 Start Epson Media Installer on one of the computers that is connected to the same printer, and then add the paper information.

[“Adding paper information” on page 40](#)

2 Start Epson Media Installer on a different computer than the one you used in step 1, and then click **Media Download**.

3 Select the same paper information as you added in step 1, and then click **Download and Register**.

Paper information is added to the paper type for the printer driver and Epson Print Layout on this computer.

When three or more computers are connected to one printer, repeat steps 2 to 3 for each computer.

Sharing edited paper information

1 Start Epson Media Installer on one of the computers that is connected to the same printer, and then edit the paper information.

[“Editing paper information” on page 42](#)

2 Click **Media Management**, select the paper information you edited in step 1, and then click **(Export)**.

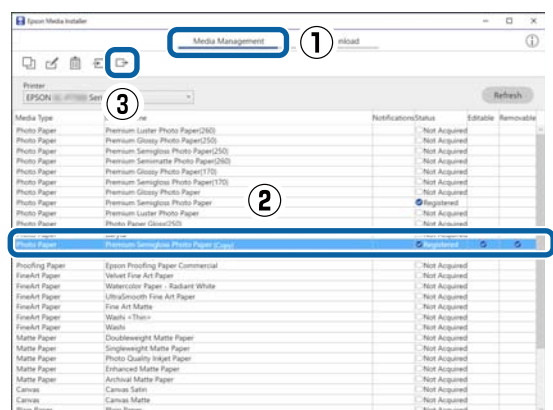

3 Select the location to save the file, and then save it.

Saved files have the extension .emy.

4 Start Epson Media Installer on a different computer than the one you used in step 1 to 3, and then click **Media Management**.

Introducing the Software

5 Click  (Import).

The **Open** dialog box is displayed.

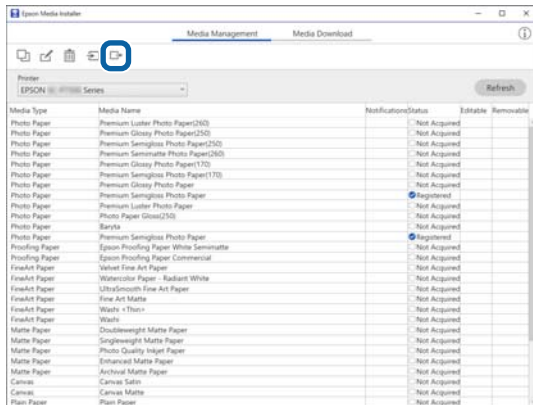

6 Select the file you saved in step 3, and then click **Open**.

The file extension is **.emy**.

If you cannot see a file with the extension **.emy**, select **EMY File(*.emy)** from the drop-down menu to the right of **File Name**.

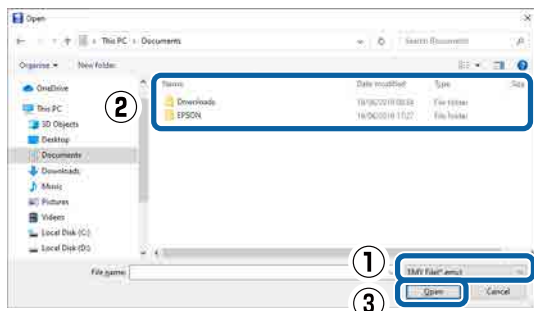

Paper information is added to the paper type for the printer driver and Epson Print Layout on this computer.

When three or more computers are connected to one printer, repeat steps 4 to 6 for each computer.

Using Web Config

This section describes how to start the software and provides a summary of its functions.

Starting

Start the software from a web browser on a computer that is connected to the same network as the printer.

1 Check the IP address of the printer from the control panel.

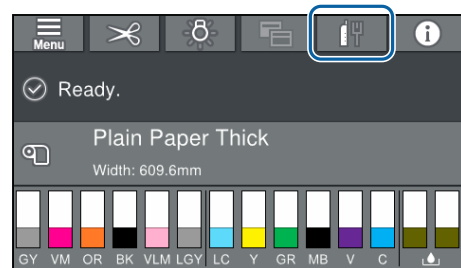

2 Start a Web browser on a computer connected to the printer over the network.

3 Enter the IP address of the printer in the address bar of the Web browser and press the **Enter** or **Return** key.

Format:

IPv4: `http://IP address of printer/`

IPv6: `http://IP address of printer/`

Example:

IPv4: `http://192.168.100.201/`

IPv6: `http://[2001:db8::1000:1]/`

Closing

Close the Web browser.

Introducing the Software

Function Summary

This section introduces the main functions of Web Config. See the *Administrator's Guide* for more details.

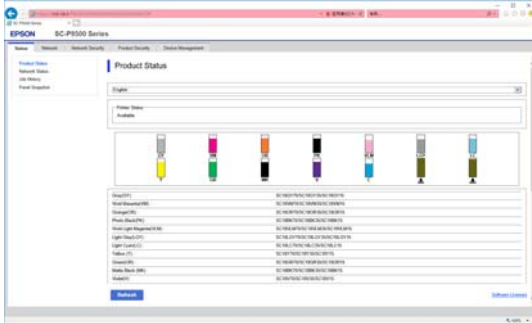

Main Functions

- Check the printer's status, such as the remaining amount of ink.
- Check and update the printer's firmware version.
- Configure the printer's network settings and advanced security settings, such as SSL/TLS communication, IPsec/IP filtering, and IEEE802.1X, which cannot be configured with the printer alone.
- You can export and import settings. You can use this to back up settings, replace printers, and so on.

Updating Software or Installing Additional Software

When you install the software during setup as described in the *Setup Guide*, Epson Software Updater is installed. Epson Software Updater allows you to update the firmware and software already installed on your computer as well as install additional software compatible with the printer.

Note:

The software is updated as needed for greater convenience and more robust functionality. We recommend setting to receive update notifications in Epson Software Updater and updating the software as soon as possible when there is a notification.

Checking Whether Updates are Available and Updating Software

1 Check that the computer and printer are in the following states.

- Computer is connected to the Internet.
- Printer and computer can communicate.

2 Start Epson Software Updater.

- Windows
Display the list of all the programs and then click Epson Software Updater in the Epson Software folder.

Note:

- If you press the Windows key (key with Windows logo mark) on the keyboard and then type the software name in the search box of the displayed window, the software appears immediately.*
- The software can also be started by clicking the printer icon on the Taskbar of the desktop and then selecting **Software Update**.*

- Mac
Select **Go - Applications - Epson Software - EPSON Software Updater**.

Introducing the Software

- 3 Select the software or manuals to be updated and then update them.

Follow the on-screen instructions.

! **Important:**
Do not turn off the computer or printer during the update.

Note:
Software not displayed in the list cannot be updated with EPSON Software Updater. Check the latest versions of software on the Epson website.

Please note that you cannot update or install software using Epson Software Updater if you are using a Windows Server OS. Download the software from the Epson website.

<http://www.epson.com>

Receiving Update Notifications

Windows

- 1 Start Epson Software Updater.
- 2 Click Auto update settings.
- 3 Select the timing to perform the update check in the Interval to Check field on the printer, and then click **OK**.

Mac

The software is set by default to check and notify whether there are updates every 30 days.

Uninstalling Software

Windows

! **Important:**

- You must log in as an Administrator.
- If the password or confirmation of an administrator is requested, enter the password and then continue with the operation.

- 1 Turn off the printer, and unplug the interface cable.
- 2 Close all applications running on your computer.
- 3 Go to the **Control Panel** and click **Uninstall a program** from the **Programs** category.



- 4 Select the software you want to remove and then click **Uninstall/Change** (or **Change/Remove/Add or remove**).

You can remove the printer driver and EPSON Status Monitor 3 by selecting **EPSON SC-XXXXX Printer Uninstall**.

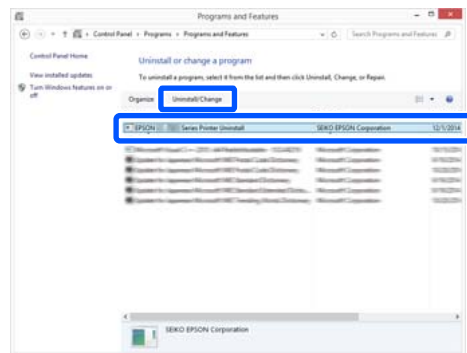

Introducing the Software

- 5** Select the target printer icon, and then click **OK**.



- 6** Follow the on-screen instructions to continue.
When the delete confirmation message appears, click **Yes**.

Restart the computer if you are reinstalling the printer driver.

Mac

When reinstalling or upgrading the printer driver or other software, follow the steps below to uninstall the target software first.

Printer Driver

Use the "Uninstaller".

Downloading the Uninstaller

Download the "Uninstaller" from the Epson website.

<http://www.epson.com/>

Using the Uninstaller

Check the procedure when downloading "Uninstaller" on the Epson website, and follow the instructions.

Other software

Drag and drop folder with the software name from the **Applications** folder into **Trash** to delete.

Basic Operations

Loading and Removing the Roll Paper

Loading Roll Paper

Load roll paper after attaching the supplied roll paper adapters.

Use the printer's roll paper adapter. Do not use roll paper adapters from other models.

Important:

Insert the paper just before printing. The roller may leave an impression on paper that is left in the printer.

Note:

- ❑ The paper that can be used in the printer is detailed in the following section.
📄 ["Supported Media" on page 168](#)
- ❑ You can load the paper while viewing the loading procedure on the screen. To view the procedure, open the roll paper cover and touch **See Description** on the control panel.

- 1** Turn on the printer.
- 2** Press Paper loading information on the control panel, and then select **Roll Paper**.



- 3** Open the roll paper cover.

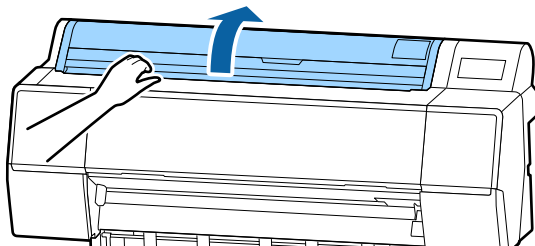

- 4** Lower the lock lever for the adapter holder to release the lock.

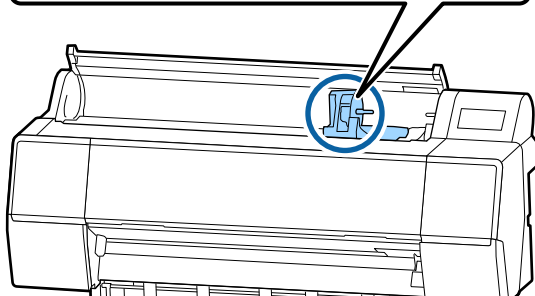
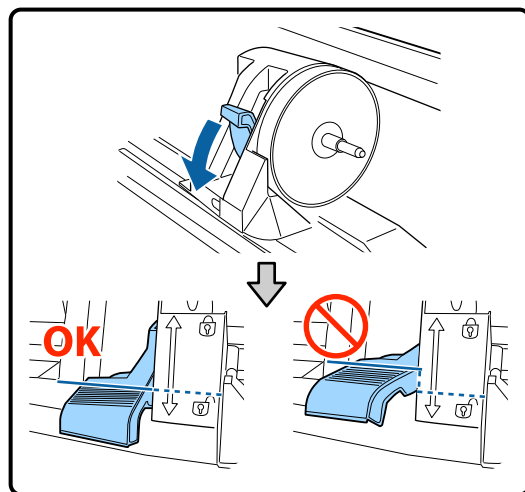

- 5** Move the adapter holder to the left. When moving the adapter holder, make sure you use the handle.

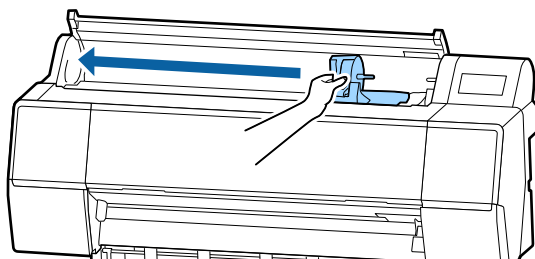

Basic Operations

- 6** Place the roll paper on top of the printer.

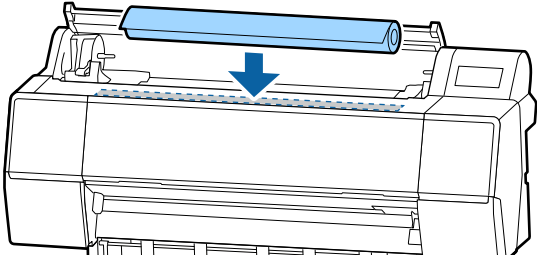

- 7** Adjust the size of the roll paper adapters to the size of the roll core.

Change the size of both of the roll paper adapters so that they are the same size.

3-inch core

2-inch core

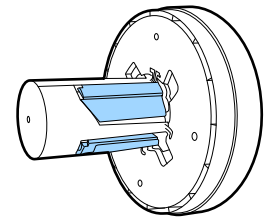
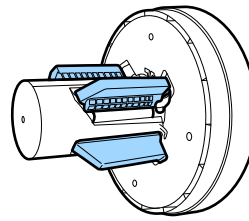
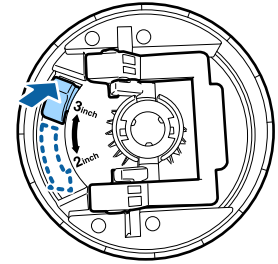
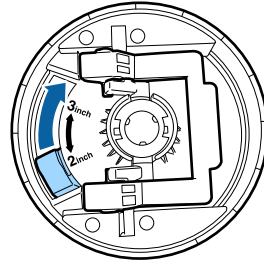

- 8** Raise the adapter lock lever to release the lock on each of the two roll paper adapters.

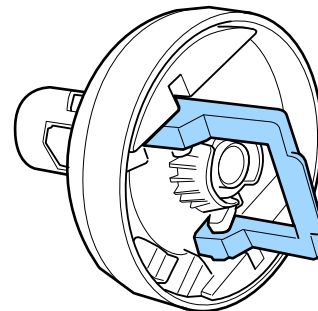
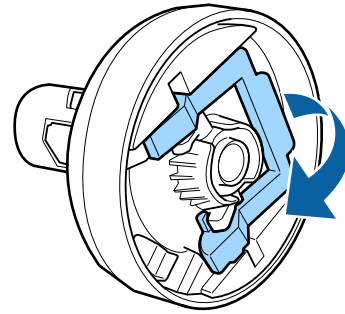

Basic Operations

- 9** Attach the roll paper adapters to both ends of the roll paper, and then lower the lock levers on the left and right to lock them in place.

Make sure you insert the adapters fully before locking them.

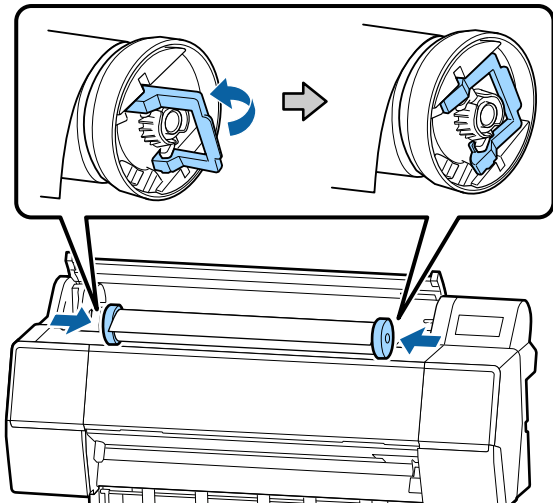

- 10** Push the roll paper to the right until it touches the roll paper loading guide.

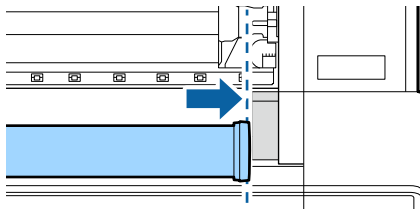

- 11** Move the adapter holder so that the ▲ on the adapter holder and the left roll paper adapter are aligned.

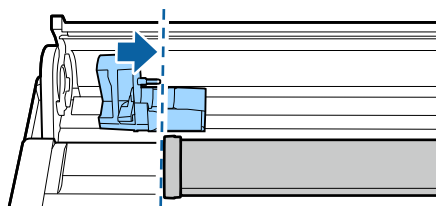

- 12** Roll the roll paper slowly into the roll paper holder.

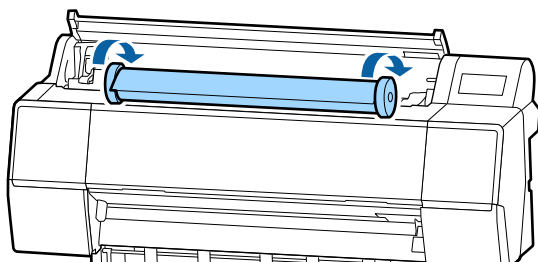

! Important:

If you slide the roll paper without rolling it, or roll it with too much force, the adapter holder or the printer may be damaged. If the adapter is damaged, you may not be able to remove it from the printer. To avoid this, remove the adapter while lifting it up.

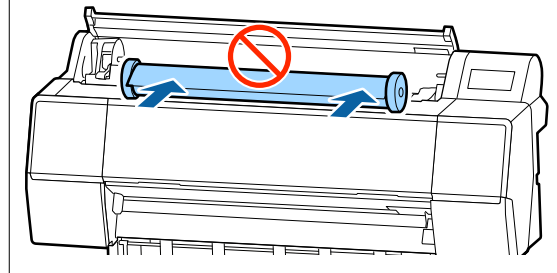

- 13** Grip the handle on the adapter holder and slide to the right until it is fully inserted to the holder shaft.

Make sure that both ends of the roll paper are seated securely to the adapters.

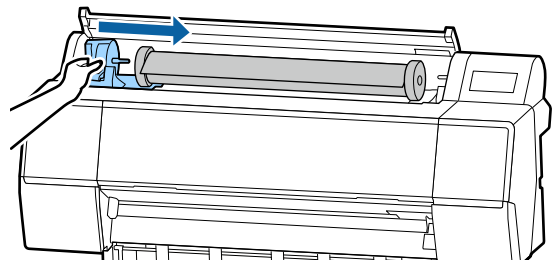

Basic Operations

- 14** Raise the lock levers on the adapter holders to lock them in place.

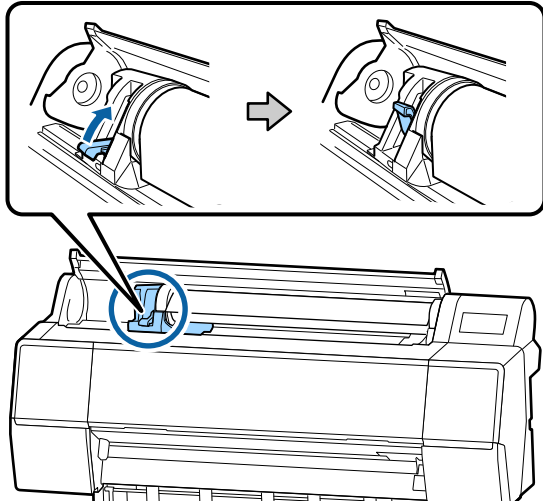

- 15** Insert the leading edge of the roll paper into the paper feed slot, and continue to feed until you hear a sound.

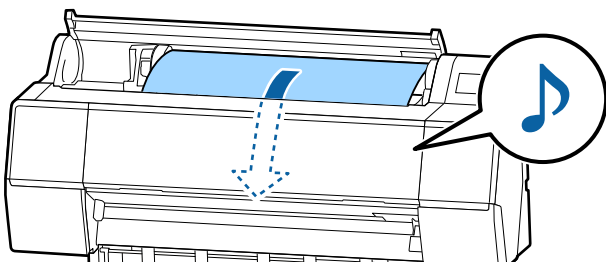
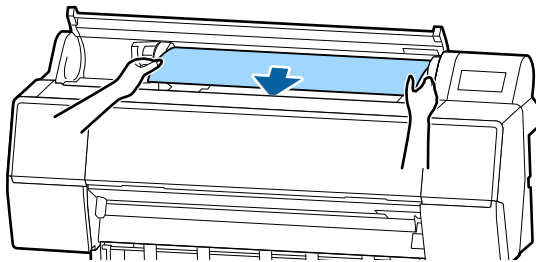

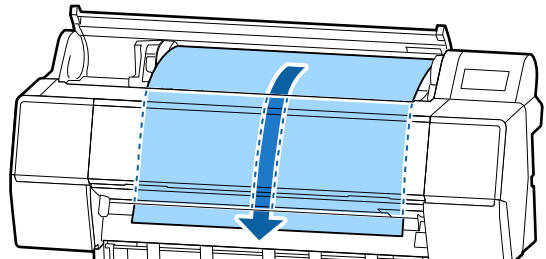
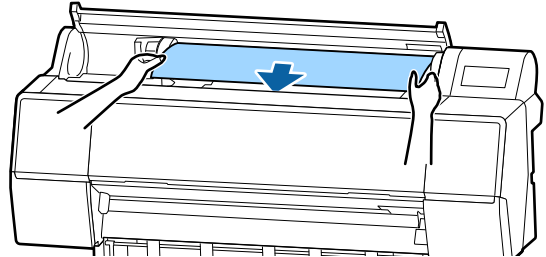

- 16** When auto paper feed is set to Off, insert the leading edge of the roll paper into the paper feed slot, and feed until the leading edge extends out of the printer.

Make sure that the roll paper is free of slack and the end is not folded.

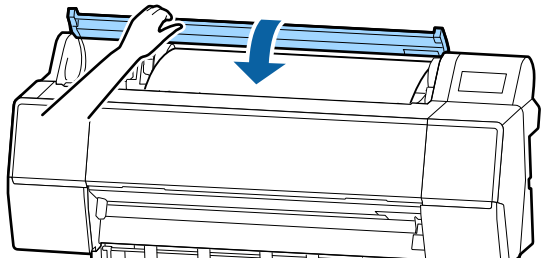

- 17** Close the roll paper cover.



- 18** Check the media type.
 [“Setting Loaded Paper” on page 38](#)

Cutting the roll paper

The printer is equipped with a built-in cutter. You can cut roll paper after printing by using one of the following methods.

- Auto Cut:**
The cutter cuts automatically at a determined position each time a page is printed in accordance with the setting of the printer driver or control panel menu.

Basic Operations

- ❑ **Manual cut:**
The cutting position is specified on the control panel, and then the roll paper is cut. A cutline is printed for manual cutting and can be used as a guide when cutting paper using the built-in cutter.

Important:

The commercially available media types, such as those shown below, may not be cut cleanly by the built-in cutter. Furthermore, cutting the following media types may damage or reduce the lifetime of the built-in cutter.

- ❑ Fine art paper
- ❑ Canvas
- ❑ Vinyl
- ❑ Matte poster board
- ❑ Adhesive paper
- ❑ Banner media

Cut these media types with commercially available scissors or a cutter in the following manner:

With the front cover closed, hold down the  - **Forward** buttons on the control panel while viewing the inside of the printer until the cutting position emerges from below the front cover. Cut the paper using scissors or a third-party cutter.

Setting Auto Cut

You can specify the method either on the control panel or the printer driver. Note, however, that the setting selected with the printer driver takes priority when the printer driver is used.

Note:

- ❑ Disable the auto cut settings in the printer and the printer driver when using the optional auto take-up reel unit.
- ❑ It may take a while to cut the roll paper.

Setting on the computer

Set **Auto Cut** from the **Roll Paper Option** in the printer driver's **Properties** (or **Printing preferences**) screen.

Setting from the printer

Set this in **General Settings - Printer Settings - Paper Source Settings - Roll Paper Setup - Cut Settings - Auto Cut** from the control panel.

Manual cut method

When **Off** is selected in the printer driver or **Off** is selected for **Auto Cut** in the control panel, the paper can be cut in any location after printing as described below.

1

With the front cover closed, hold down the  - **Forward** or **Backward** button on the control panel while viewing the inside of the printer until the cutting position reaches the position of the label.

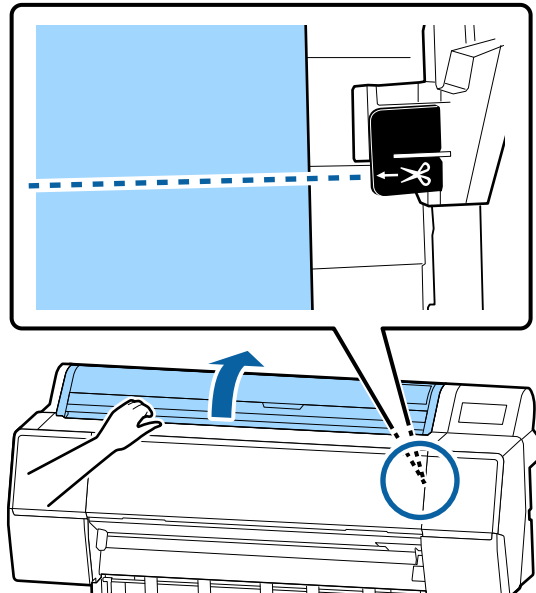

Note:

To cut the paper using the built-in cutter, the distance from the cutting position to the edge of the paper needs to be 60 to 127 mm. The necessary length differs depending on the paper type and cannot be changed. If the necessary length has not been reached, paper is fed automatically leaving a margin. Use a commercially available cutter to remove the unnecessary margin.

2

Touch Cut.

A confirmation screen is displayed. Press the **Cut** button to cut using the built-in cutter.

Basic Operations

Removing Roll Paper

This section describes how to remove and store roll paper after printing. The pressure roller may leave impressions on paper that is left in the printer.

- 1 Press Paper loading information from the home screen, and then select **Remove**.

The paper is rewound and ejected. When Manage Remaining Amount is set to On, the barcode is automatically printed prior to rewinding.

Note:

If printed paper is not cut and remains, a confirmation screen appears.

*Touch **Cut** to cut the paper at the default cut position or touch **Print Cutting Guideline** to print cut lines at the default position.*

*If you want to change the cut position or cut lines print position to a desired position, touch **Close** to cancel the message, and change the position in the **Feed/Cut Paper** menu.*

See the following for more details.

☞ "Cutting the roll paper" on page 33

- 2 Open the roll paper cover.

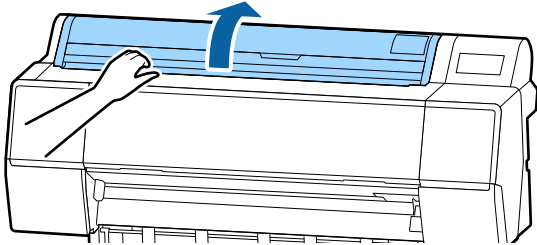

- 3 Lower the lock lever for the adapter holder to release the lock.

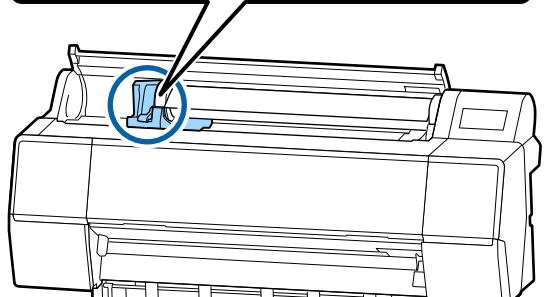
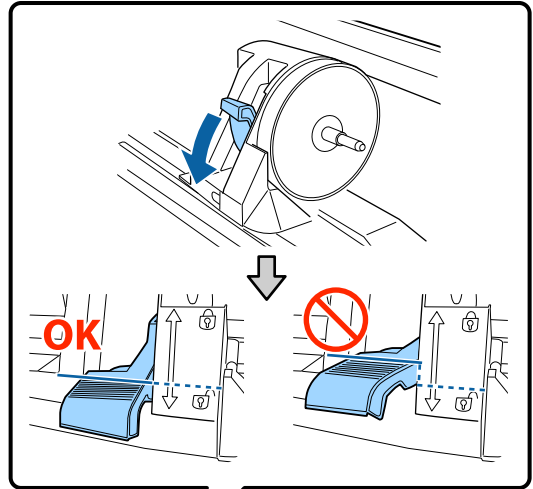

- 4 Move the adapter holder to the left. When moving the adapter holder, make sure you use the handle.

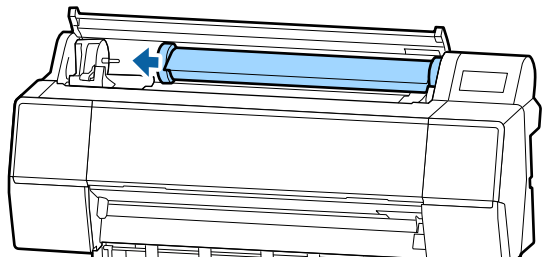
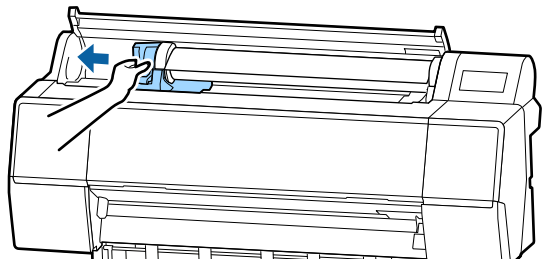

Basic Operations

- 5** Roll over the paper roll to the front side to place it on the top of the printer.

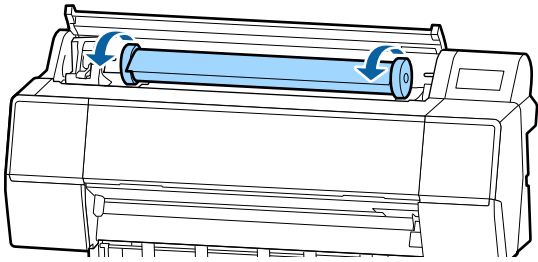

- 8** Close the roll paper cover.

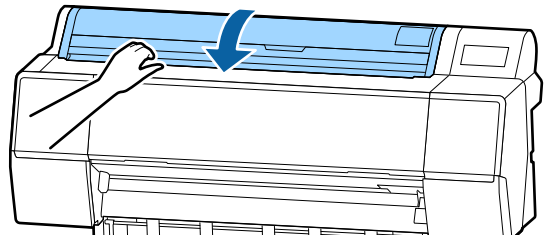

! Important:

If you slide the roll paper without rolling it, or roll it with too much force, the adapter holder or the printer may be damaged. If the adapter is damaged, you may not be able to remove it from the printer. To avoid this, remove the adapter while lifting it up.

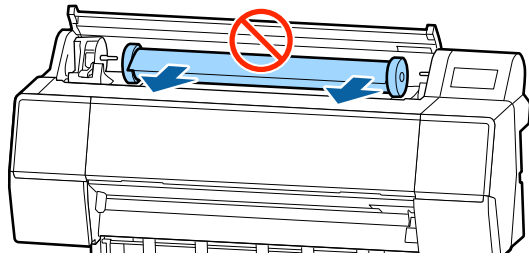

- 6** Raise the adapter lock levers to release the locks, and remove the roll paper adapters from the roll paper.

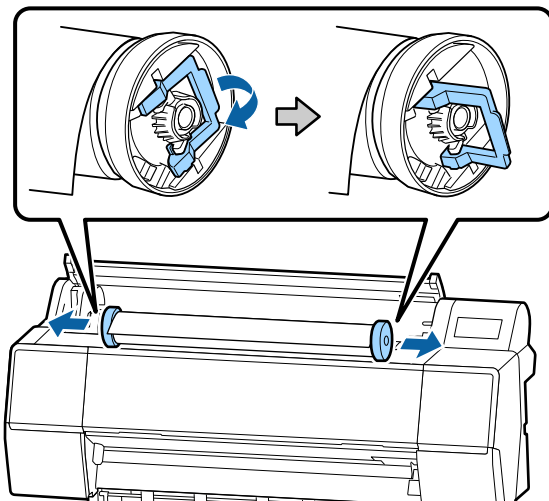

After rewinding the roll paper carefully, store it in the original package.

- 7** Raise the lock lever for the adapter holder.

Basic Operations

Loading and Removing Cut Sheets/Poster Board

Important:

If the paper is wavy or curled, use new paper. If wavy or curled paper is loaded, this printer may not be able to recognize the paper size, feed the paper, or print correctly.

We recommend that you return the paper to its original package and store it flat, and take it out of the package just before you use it.

Loading Cut Sheets and Poster Board

Important:

- ❑ Insert the paper just before printing. The roller may leave an impression on paper that is left in the printer.
- ❑ When roll paper is loaded, rewind the roll paper before loading the cut sheets.
 - 🔗 [“Removing Roll Paper” on page 35](#)

Note:

The paper that can be used in the printer is detailed in the following section.

🔗 [“Supported Media” on page 168](#)

- 1 Turn on the printer.
- 2 Press Paper loading information on the control panel, and then select **Cut Sheet** or **Poster Board**.
- 3 Open the cut sheet cover.

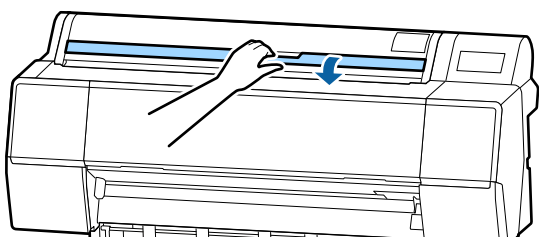

- 4 Load the paper with the side you want to print on facing forward, and the edge aligned with the line on the right.

Normally, the paper should be loaded vertically.

You can load thick paper with a length of up to 762 mm. However, you can load thick paper that is longer than 762 mm into the SC-P9500 Series by loading the paper horizontally.

When loading cut sheets, insert the leading edge until you feel resistance.

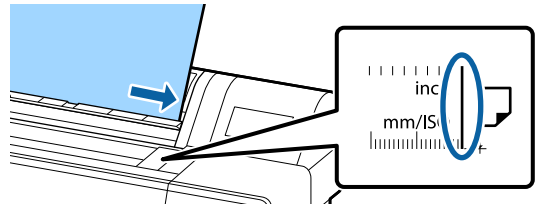
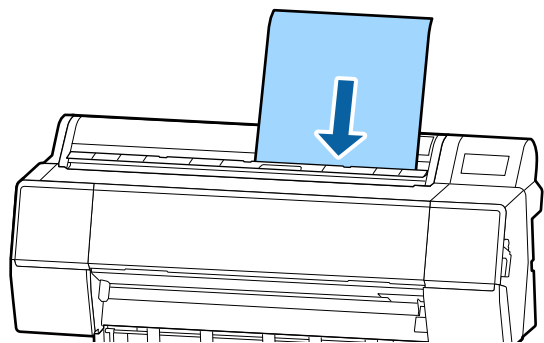

When loading poster board, insert the paper until the trailing edge is below the loading mark on the roll paper cover.



- 5 Press the **Complete - OK** buttons on the control panel.

Basic Operations

- 6 Check the media type.  "Setting Loaded Paper" on page 38

Removing Cut Sheets/Poster Board

While supporting the paper so that it does not fall, press Paper loading information on the control panel, and then select **Remove**. The paper is ejected.

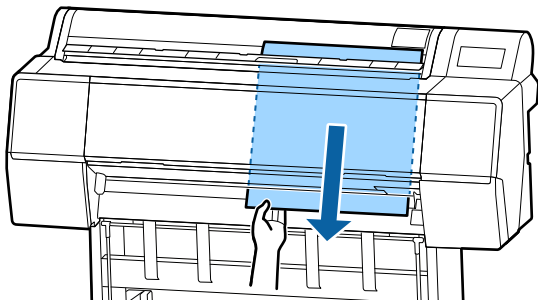

Setting Loaded Paper

Set the paper type before you start printing. Not setting a paper type that matches the loaded paper will cause wrinkles, scuffing, uneven colors, and other trouble.

Note:

Set the same settings for the printer driver as the paper type you set.

If the paper type settings on the control panel and in the printer driver are different, the paper settings in the printer driver take precedence. However, if the paper type set on the control panel is the same as the paper type saved in Custom Paper Setting, the paper settings on the control panel take precedence.

See the following for more details on Custom Paper Setting.

 "Make custom paper settings on the control panel" on page 43

How to Set

- 1 The paper type is shown on the screen displayed after loading paper. Check that the loaded paper and the paper type displayed on the screen match.

Roll Paper

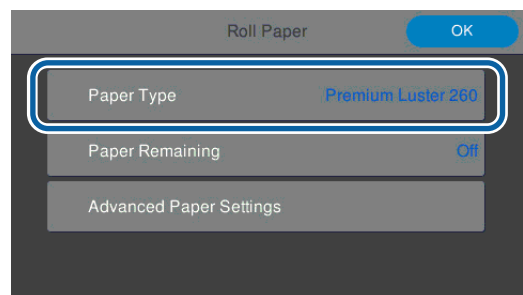

Cut sheet/Poster board

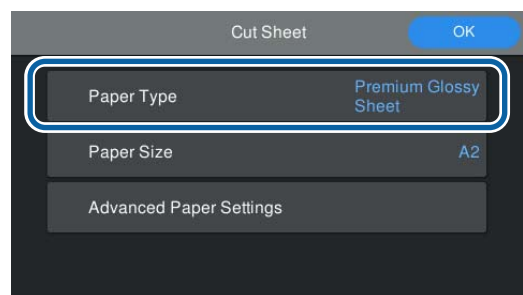

Basic Operations

If the paper type displayed does not match the paper type that you have loaded, touch **Paper Type** to set the paper type.

See the following if the paper type you have loaded is not displayed on the control panel.

[🔗 “When there is no paper information on the control panel or in the driver” on page 39](#)

- 2** To manage the amount of roll paper remaining, set **Remaining Amount Management to On**, and then set **Remaining Amount** and **Remaining Alert**.

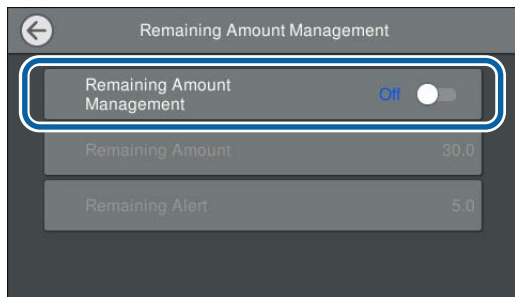

Note:

When Manage Remaining Amount is set, a barcode is printed on the leading edge of the paper when you remove the roll paper. The next time you load the roll paper, the amount remaining and the paper type are set automatically.

However, depending on the paper, the printer may not be able to read the barcode.

- 3** For cut sheets/poster board, check that the loaded paper and the paper size displayed on the screen match.

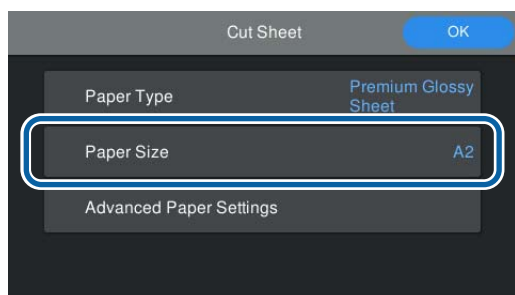

If the loaded paper does not match the paper size displayed on the screen, touch **Paper Size** to set the paper size.

- 4** Touch **OK** on the paper setting screen to start feeding the paper.

When the message "Ready." is displayed on the Home screen, you can start printing.

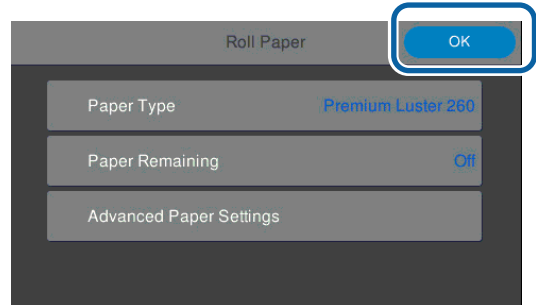

Note:

To make detailed paper settings such as the platen gap and drying time, touch **Advanced Paper Settings**, and then set each item.

See the following for items you can set.

[🔗 “Menu List” on page 111](#)

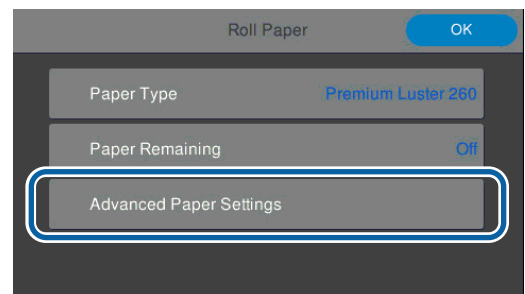

The advanced paper settings are saved for the currently selected paper type.

When there is no paper information on the control panel or in the driver

If paper information is not displayed on the control panel or in the printer driver, you can use one of the following methods to make paper settings.

- Use Epson Media Installer
- Make custom paper settings on the control panel

Basic Operations

Use Epson Media Installer

You can add paper information over the Internet. You can also edit the paper information you have added.

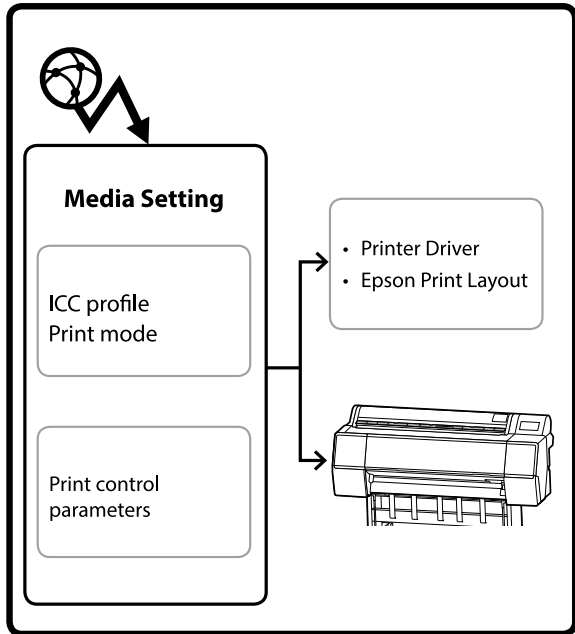

Paper information, including ICC profiles, print modes, and print control parameters, is downloaded from servers.

Downloaded paper information is saved in the printer driver, Epson Print Layout, or the printer.

Adding paper information

- 1 Use one of the following methods to start Epson Media Installer.

For Windows

Click in the following order.

Start - Epson Software - Epson Media Installer

For Mac

Click in the following order.

Applications - Epson Software - Epson Utilities - Epson Media Installer.app

Epson Edge Dashboard



Printer Driver (Windows)

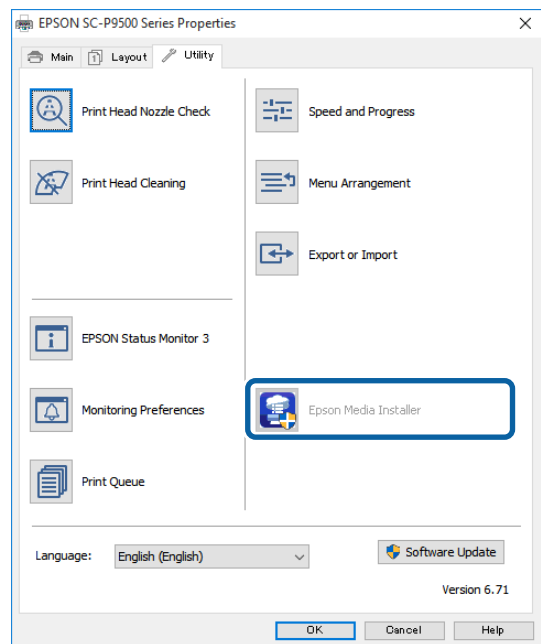

Download the latest printer driver from the Epson Website.

Epson Media Installer starts and displays a list of paper information that you can add.

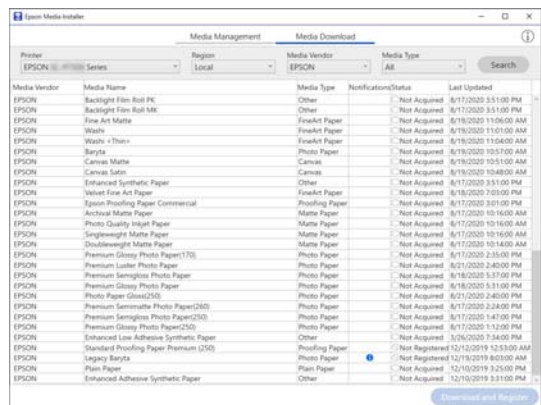

Basic Operations

2 Add the paper information.

Click **Media Download**, and then select the paper you want to use. Click **Download and Register** to add the selected paper information.

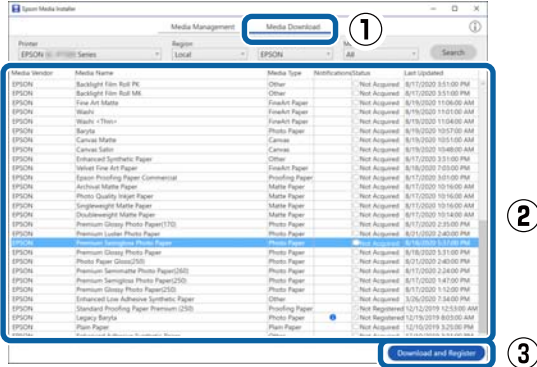

3 Paper information is added to the paper type for the printer driver and Epson Print Layout.

Select the paper you want to print on.

Note:

*Paper information added using Epson Media Installer is also added to **Printer Settings - Custom Paper Setting** on the control panel.*

You cannot change the paper information settings on the control panel.

Printer Driver (Windows)

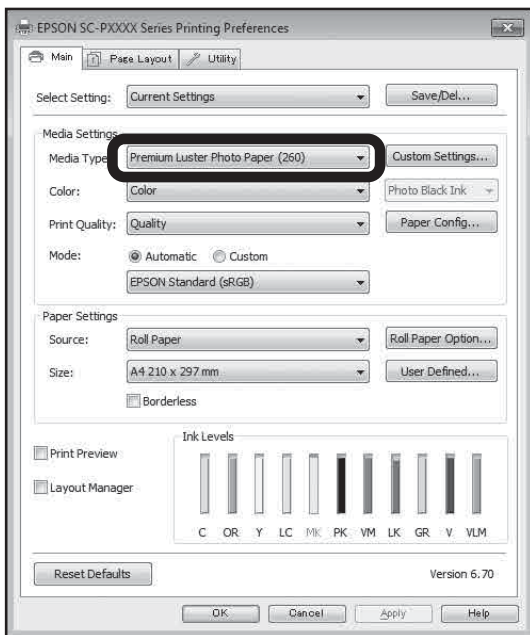

Printer Driver (Mac)

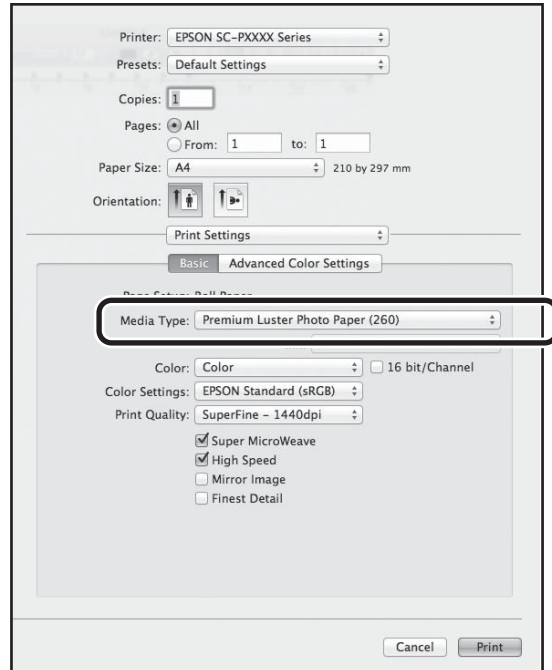

Epson Print Layout

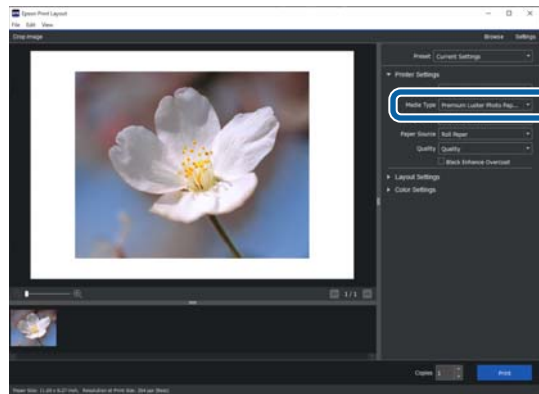

Basic Operations

Important:

If you uninstall and re-install the printer driver, you need to re-register the paper information in Epson Media Installer.

If you do not re-register the paper information, the paper information you added previously using Epson Media Installer may not be displayed in the printer driver, Epson Print Layout, and so on.

Re-registering paper information

Start Epson Media Installer, and then click **Media Management - Refresh**.

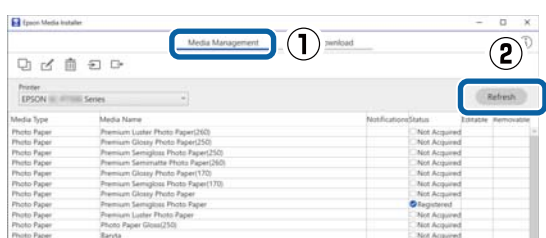

Editing paper information

To edit paper information, first copy the added paper information and then change the settings. You cannot directly edit paper information that has been added.

- 1 Start Epson Media Installer, and then click **Media Management**.

Paper information saved on the printer is displayed.

However, paper information set in **Custom Paper Setting** on the printer's control panel is not displayed.

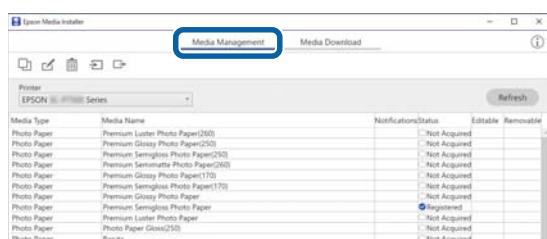

- 2 Select the paper information you want to edit, and then click (Copy Media).

You can only copy paper information that is labeled as **Registered** in **Status** in the list.

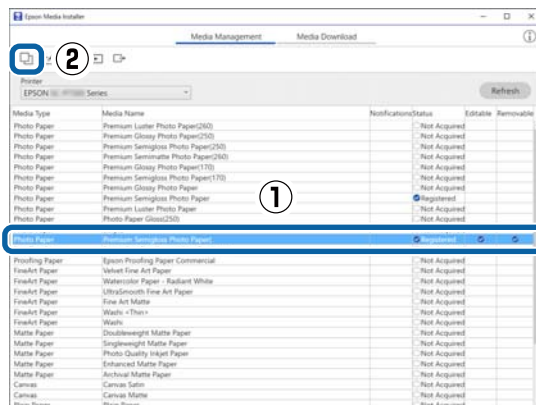

A copy of the paper information is created. Copy is displayed at the end of the media name of the copy.

- 3 Select the paper information you want to copy, and then click (Edit).

The Edit Media Settings screen is displayed.

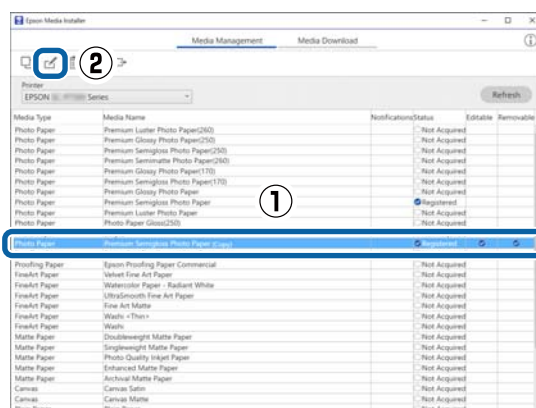

- 4 Change the settings according to your printing needs and so on, and then click **OK**.

See the following for more information on the Edit Media Settings screen.

[“Edit Media Settings Screen Configuration” on page 22](#)

- 5 The edited paper information is reflected in the printer driver and Epson Print Layout.

Basic Operations

Notes on using the Adobe® PostScript® 3™ expansion unit

Make sure that the custom paper information registered in the Adobe PostScript 3 expansion unit and in the printer match. If the custom paper information does not match, colors may not print correctly due to inconsistencies in the paper settings between the Adobe PostScript 3 expansion unit and the printer.

- ❑ When using the Adobe PostScript 3 expansion unit for the first time
Delete any custom paper information that you have already registered to the printer, and then add it again once the Adobe PostScript 3 expansion unit is installed.
- ❑ When adding or deleting custom forms while the Adobe PostScript 3 expansion unit is removed
With the Adobe PostScript 3 expansion unit installed, delete the custom form, and then add it again.

Make custom paper settings on the control panel

- 1 Select **General Settings - Printer Settings - Custom Paper Setting** on the control panel.

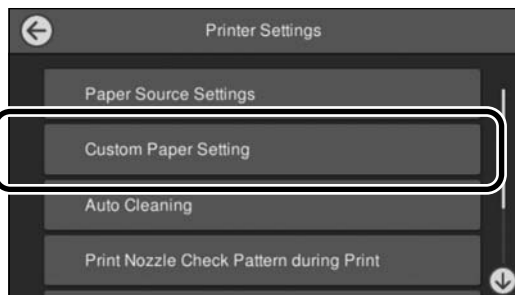

- 2 Select a paper number from 1 to 30 to save the settings.

- 3 Set the paper information.
Make sure you set the following items.

- ❑ Change Reference Paper
- ❑ Paper Thickness
- ❑ Roll Core Diameter (roll paper only)
- ❑ Paper Feed Offset

Note:

Paper Feed Offset is a function that allows you to adjust the difference between the data size and the print size.

Example:

When printing at a data size of 100 mm and a print size of 101 mm, the offset is 1.0%. Therefore, you would enter a value of -1.0%.

See the following for details on the other settings.

 [“General Settings” on page 116](#)

Basic Operations

Using the Paper Basket

Using the paper basket allows you to print smoothly by preventing the paper from getting dirty or wrinkled.

! *Important:*

Normally the capacity of the paper basket should be one sheet at a time.

If multiple sheets are left in the basket, they may not be ejected correctly.

Ejecting paper from the front of the printer

Since the paper is output with the printing surface facing up, it helps to protect it from being damaged.

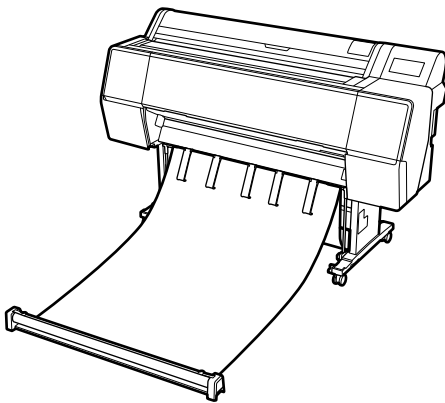

Ejecting paper from the rear of the printer

Allows you to eject paper in a smaller space.

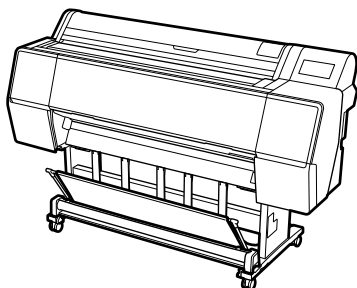

Loading and Storing for Front Ejecting

Loading for front ejecting

This section explains how to switch the paper basket from the stored state to the ready state.

- 1 Check that the paper supports are in the position shown in the illustration.

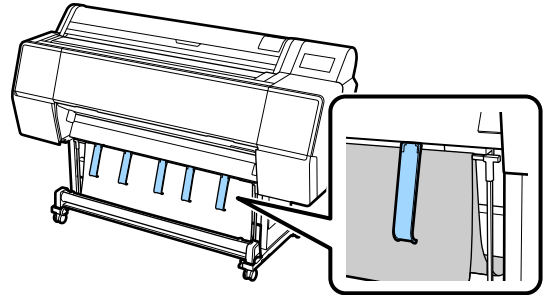

- 2 Hold the roll paper with both hands and pull it straight down.

Adjust the length of the cloth you are pulling out according to the length of the paper you intend to print.

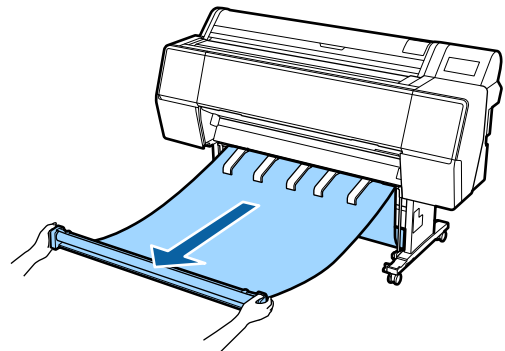

- 3 Place the roll paper so that it does not touch the floor.

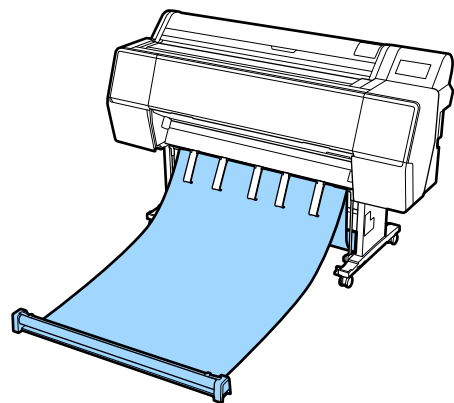

Basic Operations

! **Important:**

If you print while the cloth is stretched too far or on the floor, you may not be able to eject correctly.

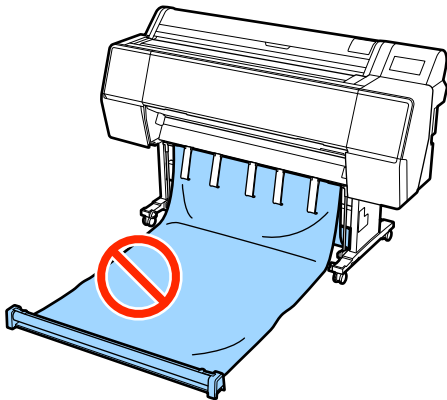
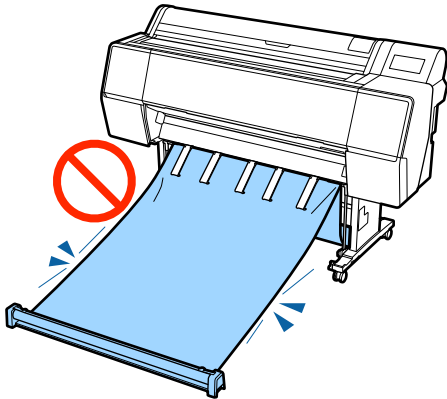

Note:

If you are printing on thick paper, the leading edge of the paper may catch on the cloth and may not be ejected correctly. If this occurs, you can adjust the left and right bands to improve the angle of the cloth.

To reduce the angle of the cloth, pass the string through a hole close to the cloth.

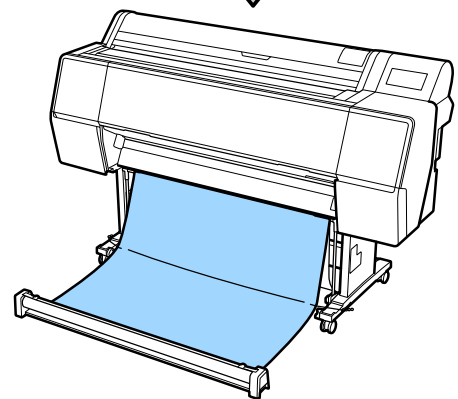
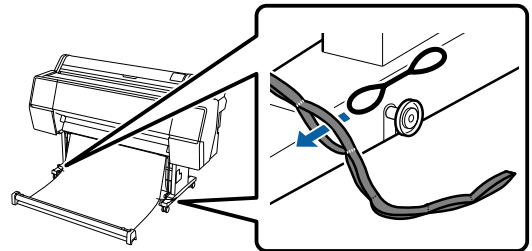

Basic Operations

Note:

To increase the angle of the cloth, pass the string through a hole close to the edge of the belt.

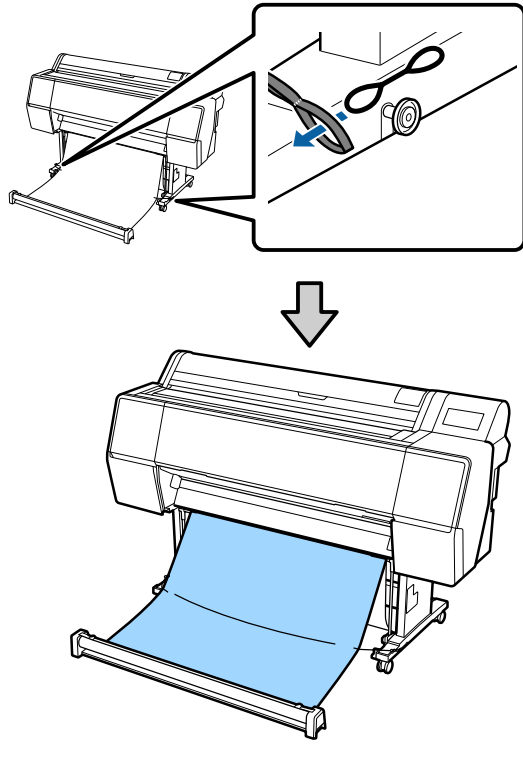

Note:

If the paper is too warped, it may curl back on itself when it is ejected after auto cutting and scratch the printing surface. If the paper curls too much after auto cutting, we recommend setting Auto Cut to Off.

Storing

This section explains how to change from front ejecting to stored.

Note:

The hand strap for the roll section is only supplied with the SC-P9500 Series.

1

Lift the roll section off the floor.

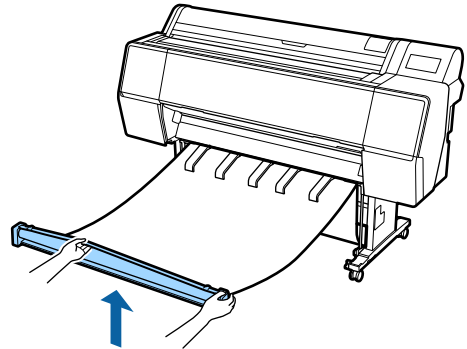

2

While holding down the button on the right of the roll section, move straight towards the printer.

You can wind up the cloth evenly by feeding the bottom of the cloth over the iron frame.

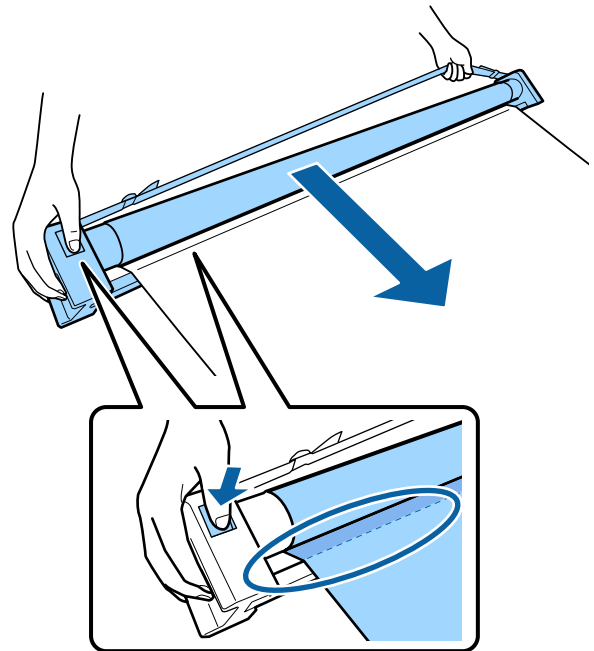

3

Place the roll in the position shown in the illustration of the stand.

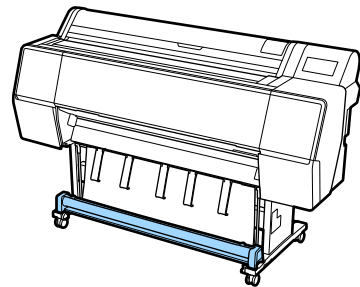

Basic Operations

- 4 Rotate the roll section counter-clockwise a little to add a little slack and prevent the cloth from stretching during storage.

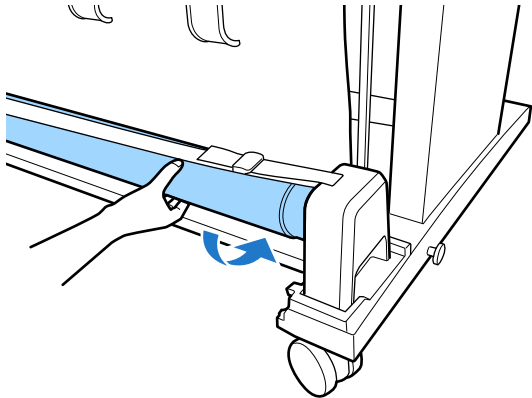

If there are lumps in the cloth, pat it down from the top to flatten it to prevent it from becoming deformed during storage.

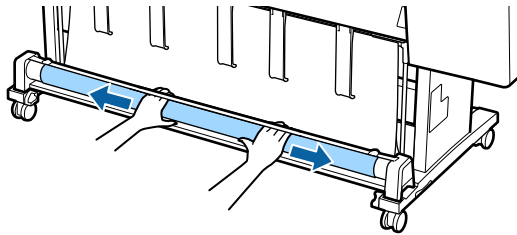

Loading for rear ejecting

This section explains how to switch the paper basket from the stored state to the ready state.

- 1 Raise the paper supports to the horizontal position.

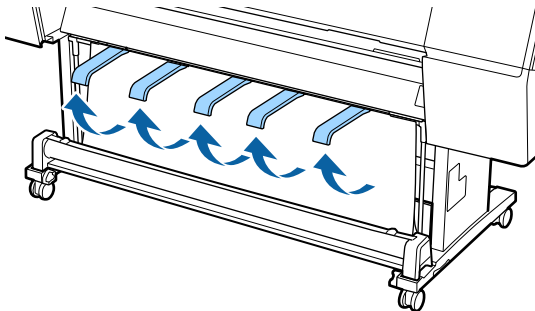

- 2 Lower the left and right arms of the paper basket toward you until it touches the roll section.

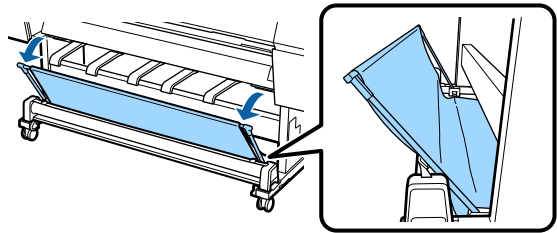

- 3 Lower the output supports until they are vertical as shown in the illustration.

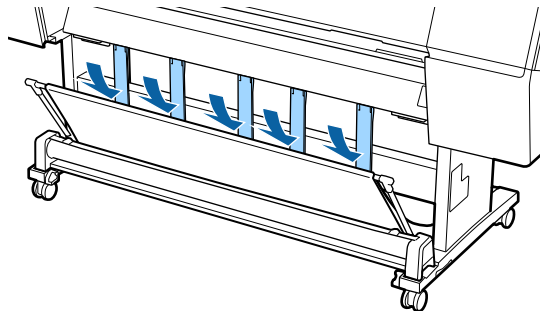

- 4 Return the left and right arms of the paper basket to their original position until you hear them click into place.

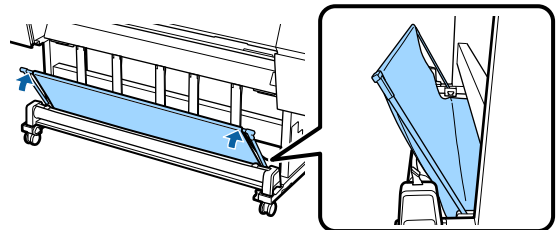

Basic Operations

Using the Auto Take-up Reel Unit (SC-P9500 Series Only)

The optional auto take-up reel unit automatically takes up paper as it is printed. It improves efficiency for banners or large jobs involving continuous printing on roll paper.

The auto take-up reel unit for this printer can take up paper in either of the directions shown below. Some types of paper may not support one or the other of these directions or may place restrictions on the take-up direction.

See the following section for information on take-up support and take-up direction.

[“Epson Special Media Table” on page 168](#)

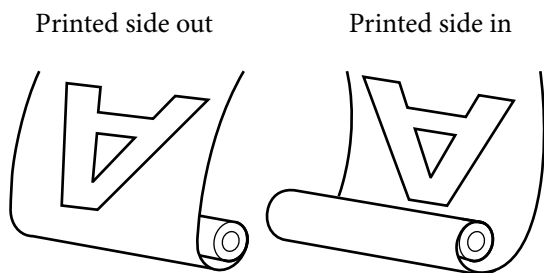

Taking-up with printed side out places the printed surface on the outside of the roll.

Taking-up with printed side in places the printed surface on the inside of the roll.

Caution:

- ❑ Fix the roll core for the auto take-up reel unit in place as described in the documentation. Dropping the roll core could cause injury.
- ❑ Be careful that your hands, hair, or other objects do not get caught in the moving parts of the auto take-up reel unit. Failure to observe this precaution could result in injury.

Important:

Confirm that the end of the roll is cut straight across. The unit will not function as expected if the end of the roll is wavy or curved.

[“Manual cut method” on page 34](#)

Note:

For information on installing the auto take-up reel unit, see the documentation supplied with the auto take-up reel unit.

Using the Control Panel

This section describes how to use the control panel for the auto take-up reel unit.

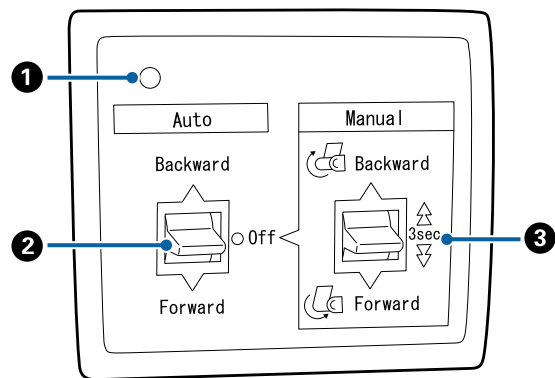

1 Power lamp

Displays the status of the auto take-up reel unit.

On : The auto take-up reel unit is ready for use.

Flickering : The auto take-up reel unit is in use.

Blinking : The auto take-up reel unit is in power-saving mode.

Intermittent blinking : An error has occurred.

Off : The power is off.

2 Auto switch

Selects the auto take-up direction.

Basic Operations

Backward : The roll is taken up with the printable side in.

Forward : The roll is taken up with the printable side out.

Off : The auto take-up reel unit does not take up paper.

3 Manual switch

Selects the manual take-up direction.

The selected option takes effect when the Auto switch is in the Off position.

Backward : The roll is taken up with the printable side in.

The speed will increase after the button is pressed for more than three seconds.

Forward : The roll is taken up with the printable side out.

The speed will increase after the button is pressed for more than three seconds.

The direction of the flange to the auto take-up reel unit varies depending on the roll core size (core diameter) being used.

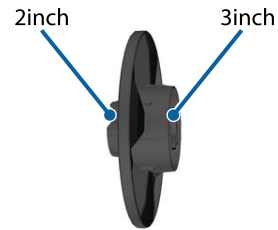

Attaching the Paper

This section describes how to attach roll paper to the auto take-up reel unit roll core.

The procedure varies with the take-up direction.

! Important:

Before proceeding, set **Auto Cut** to **Off**. Using the auto take-up reel unit when **On** is set causes errors.

[“Cutting the roll paper” on page 33](#)

Attaching the Roll Core

! Important:

- ❑ Use a roll core the same size (width and core diameter) as the roll paper you are printing on.
If the size of the roll core (width and core diameter) is different, it may not be wound correctly.
- ❑ If the roll core is deformed or the surface is damaged, it cannot be used as a take-up roll core.

Taking Up the Paper Printable Side Out

For information on installing the roll core, see the *Setup Guide* for the optional auto take-up reel unit.

- 1 Set the auto take-up reel unit Auto switch to Off. Plug the power cord into an outlet and confirm that the power lamp lights.

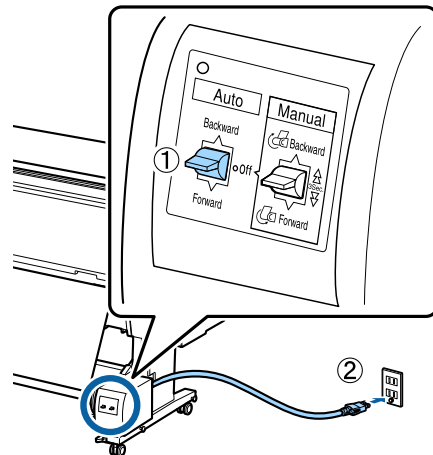

- 2 Turn on the printer.

Basic Operations

- 3** Check that the roll paper is correctly loaded in the printer.
- 4** Select Paper loading information - **Prepare for Take-up** on the printer's control panel.
The paper is fed to the roll core.

- 5** Tape the end to the roll core.
Place tape (available from third-party suppliers) at the center and then at the left and right ends.

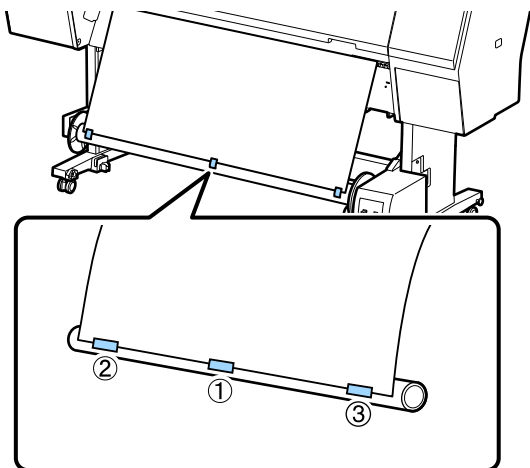

- 6** Flip the Manual switch on the auto take-up reel unit to Forward, and take up as much paper as possible.

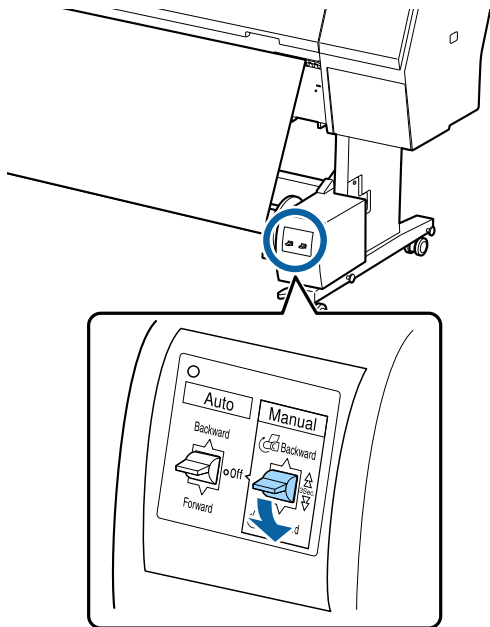

After wrapping the paper around the core, ensure that paper around the core is sufficiently loose.

Note:

The tensioner supplied with the auto take-up reel unit is used with some types of paper. Slacken the paper and insert the tensioner near the center of the paper as shown. See the following section for information on paper that requires the tensioner.

➤ "Epson Special Media Table" on page 168

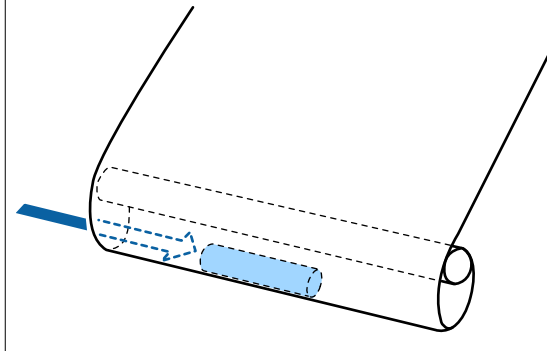

- 7** Set the auto take-up reel unit Auto switch to Forward.

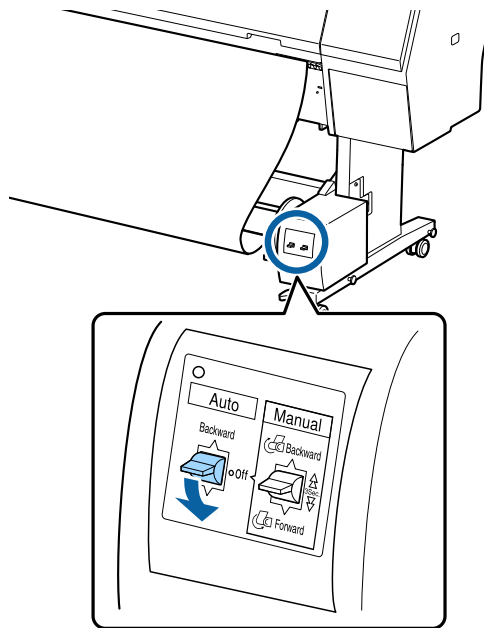

Taking Up the Paper Printable Side In

For information on installing the roll core, see the *Setup Guide* for the optional auto take-up reel unit.

Basic Operations

- 1 Set the auto take-up reel unit Auto switch to Off. Plug the power cord into an outlet and confirm that the power lamp lights.

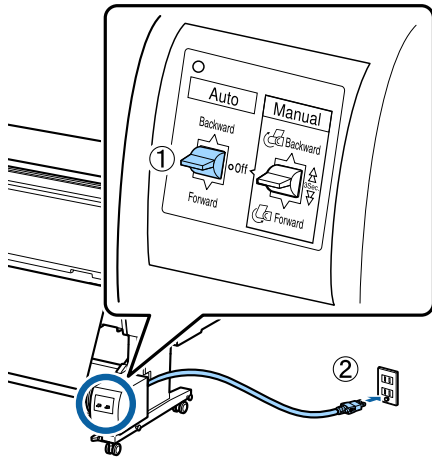

- 2 Turn on the printer.
- 3 Check that the roll paper is correctly loaded in the printer.
- 4 Select Paper loading information - **Prepare for Take-up** on the printer's control panel.
The paper is fed to the roll core.
- 5 Tape the end to the roll core.
Place tape (available from third-party suppliers) at the center and then at the left and right ends.

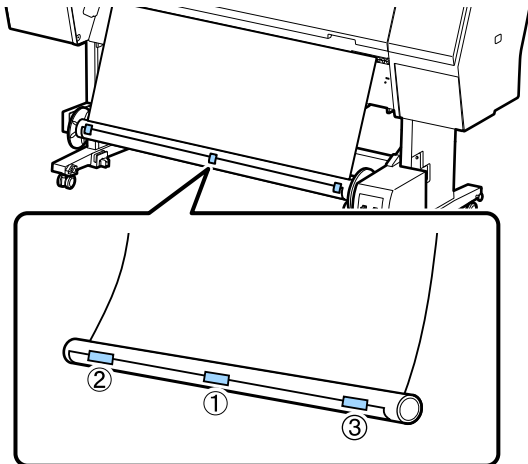

- 6 Flip the Manual switch on the auto take-up reel unit to Backward, and take up as much paper as possible.

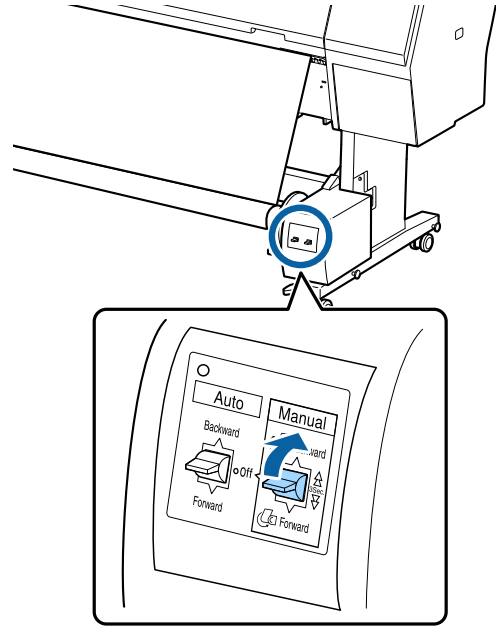

After wrapping the paper around the core, ensure that paper around the core is sufficiently loose.

- 7 Set the Auto switch to Backward.

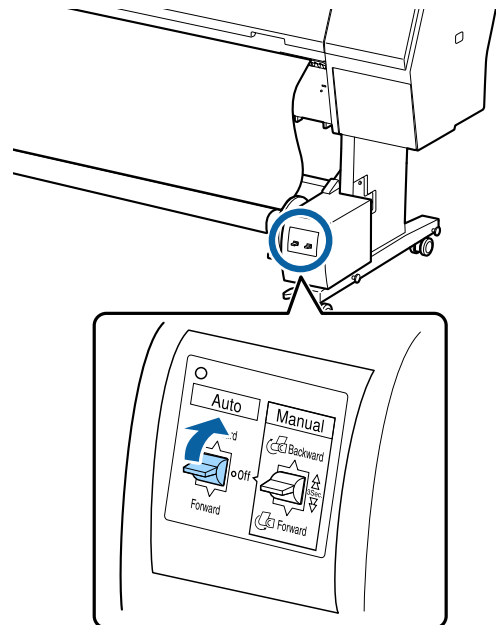

Removing Paper from the Auto Take-up Reel Unit

This section describes how to remove paper from the auto take-up reel unit.

Basic Operations



Caution:

Removing paper from the auto take-up reel unit requires two workers, one on each end of the roll.

A single worker working by his or herself could drop the roll, resulting in injury.

- 1 Set the auto take-up reel unit Auto switch to Off.

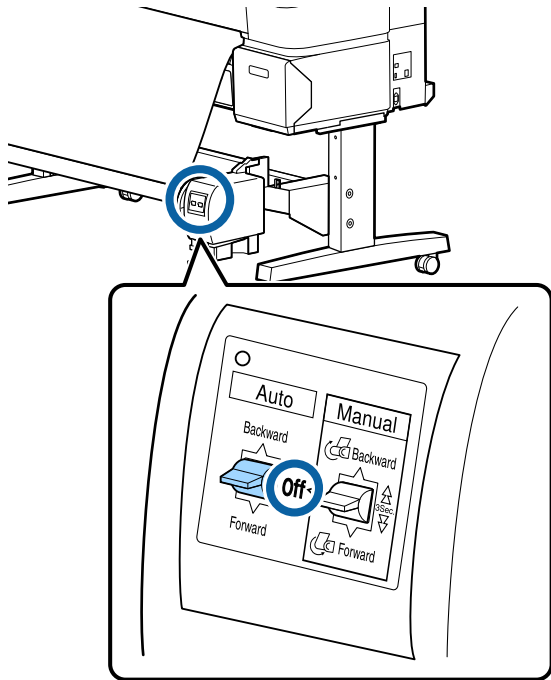

- 2 Cut the paper and take it up until it is all on the auto take-up reel unit roll core.

When Take-up After Cut is set to ON

Paper is automatically wound up after cutting.

When cutting, make sure you support the paper by hand so that the printed surface does not touch the floor. If you cannot take-up all the paper, flip the Auto switch to Off if necessary, and then continue taking up using the Manual switch.

When Take-up After Cut is set to Off

Paper is not automatically wound up after cutting.

Follow the steps below to cut the paper while supporting it with your hands so that the printed surface does not touch the floor, and then take-up the paper manually.

- (1) Flip the Auto switch to Off.

- (2) Cut the paper.

- (3) Keep the Manual switch pressed in the take-up direction (either Forward or Backward).

 [“Manual cut method” on page 34](#)

- 3 Unlock the movable unit and remove it from the roll core.

When removing the movable unit, support the roll core with one hand to prevent it falling to the floor.

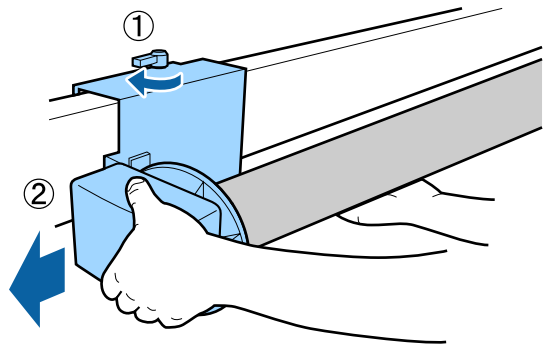

- 4 Remove the roll core from the auto take-up reel unit.

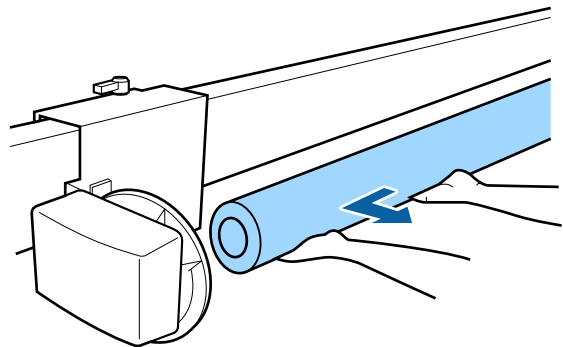

Basic Operations

Basic Printing Methods

This section explains how to print and how to cancel printing.

Make sure you set the same paper type in the printer driver as you set on the control panel.

If the paper type settings on the control panel and in the printer driver are different, the paper settings in the printer driver take precedence. However, if the paper type set on the control panel is the same as the paper type saved in Custom Paper Setting, the paper settings on the control panel take precedence.

See the following for more details on Custom Paper Setting.

[“Make custom paper settings on the control panel” on page 43](#)

See the following for more details on stopping printing.

[“Canceling Printing \(Windows\)” on page 56](#)

[“Canceling Printing \(Mac\)” on page 57](#)

Printing (Windows)

Make print settings such as paper size and paper source from the connected computer and then print.

1 Turn on the printer, and load the paper.

[“Loading and Removing the Roll Paper” on page 30](#)

[“Loading and Removing Cut Sheets/Poster Board” on page 37](#)

2 When you have created the data, click **Print** in the **File** menu.

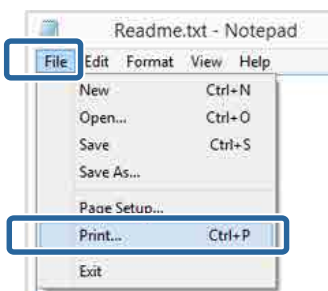

3 Make sure your printer is selected, and then click **Preferences** or **Properties** to display the settings screen.

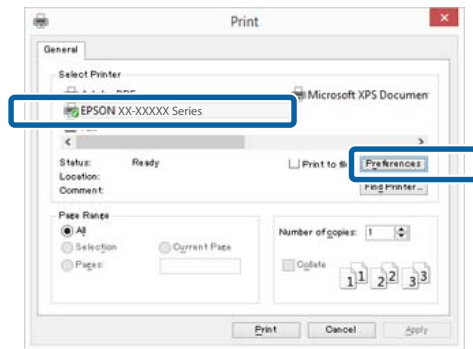

4 Select the **Media Type**, **Color**, **Print Quality**, **Mode**, and **Source** according to the paper loaded in the printer.

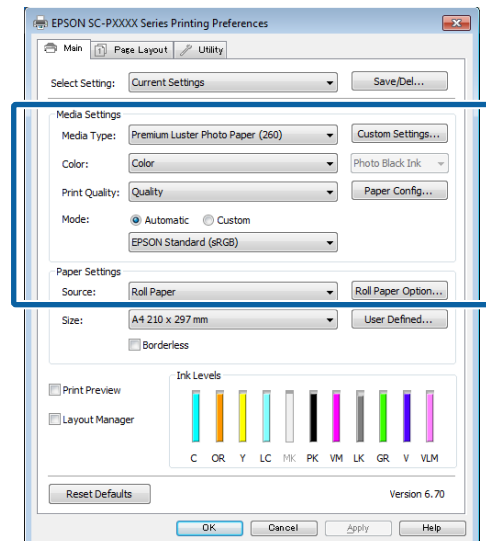

Basic Operations

- 5 Make sure you select the same **Page Size** as you set in the application.

After making the settings, click **OK**.

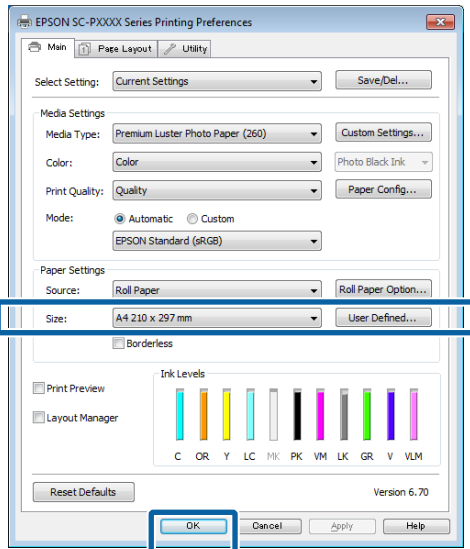

- 6 When settings are complete, click **Print**.

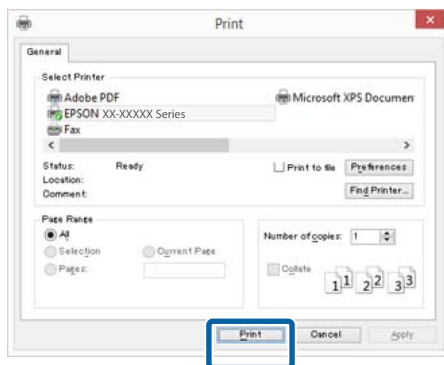

The progress bar is displayed, and printing starts.

Screen while printing

The following screen is displayed when you start printing, and the progress bar (the computer's processing status) is displayed. On this screen you can check the remaining ink level, product numbers for the ink cartridges, and so on.

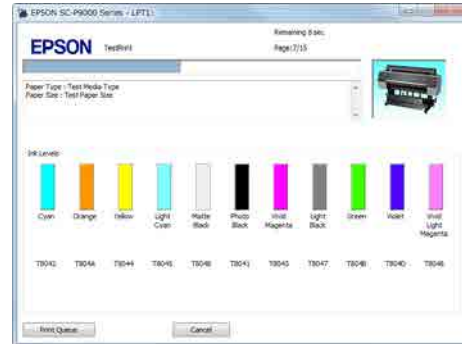

An error message is displayed if an error occurs or an ink cartridge needs replacing while printing.



Performing Printing (Mac)

Make print settings such as paper size and paper source from the connected computer and then print.

- 1 Turn on the printer, and load the paper.

[“Loading and Removing the Roll Paper” on page 30](#)

[“Loading and Removing Cut Sheets/Poster Board” on page 37](#)

Basic Operations

2 When you have created the data, from the **File** menu of the application, click **Print** and so on.

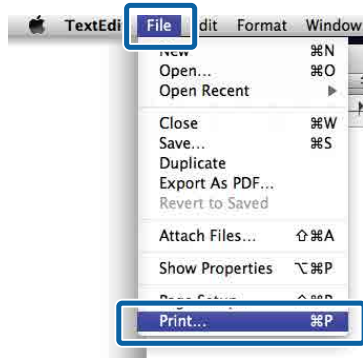

3 Click **Show Details** at the bottom of the screen.

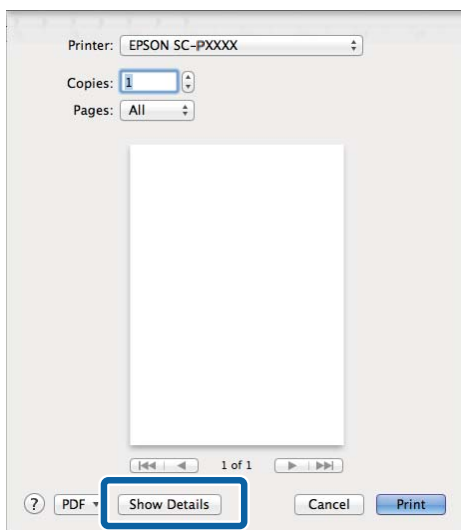

For Mac OS X v10.6.8, click the arrow (▼) on the right of the printer name to make settings on the Page Setup screen.

Note:

If page settings are not displayed in the print dialog, click the "page settings" option (e.g., **Page Setup**) in the **File** menu.

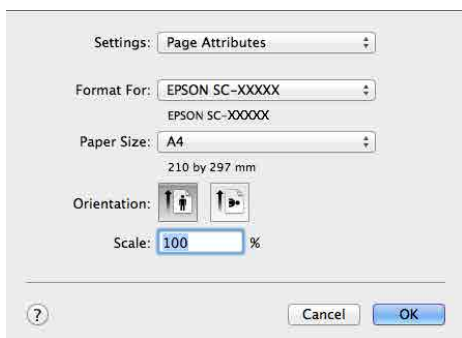

4 Check that this printer is selected, and then set the paper size.

Select the paper size, borderless printing options, and paper source in the **Paper Size** menu.

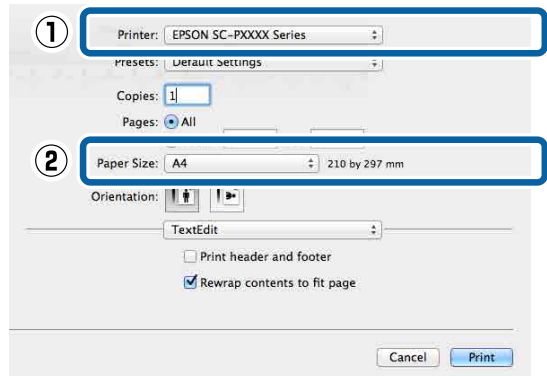

5 Select **Print Settings** from the list, and then set each item.

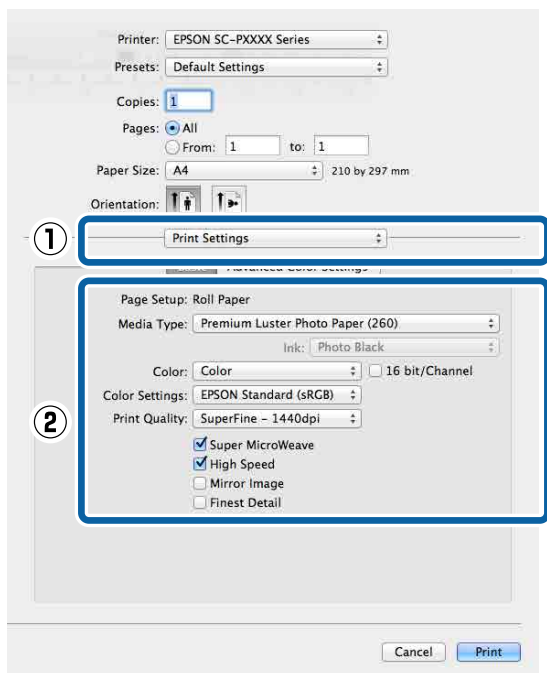

Set the **Media Type**, **Color**, **Print Quality**, and other settings according to the type of paper loaded in the printer. Normally, you can print correctly just by setting items in the **Print Settings** screen.

6 When settings are complete, click **Print**.

Basic Operations

The printer icon is displayed in the Dock while printing. Click the printer icon to display the status. You can check the progress of the current print job and the printer status information. You can also cancel a print job.

Also, if an error occurs while printing, a notification message is displayed.

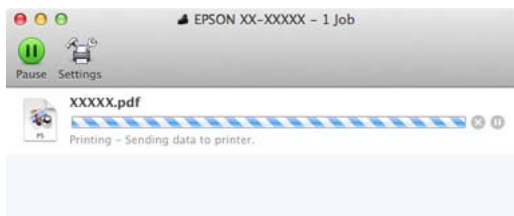

Canceling Printing (Windows)

When the computer has finished sending data to the printer, you cannot cancel the print job from the computer. Cancel on the printer.

➔ “Canceling Printing (from the Printer)” on page 57

When the progress bar is displayed

Click **Cancel**.

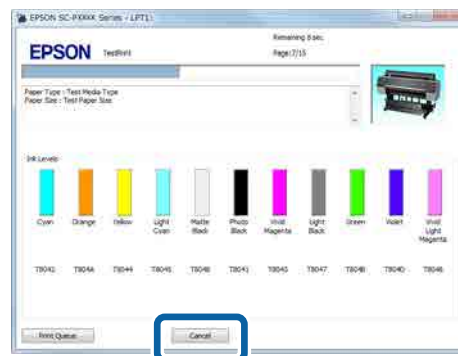

When the progress bar is not displayed

1

Click the printer icon on the Taskbar.



Whether or not an icon is displayed depends on the settings selected for Windows.

Basic Operations

- 2 Select the job you want to cancel, and then select **Cancel** from the **Document** menu.

To cancel all jobs, click **Cancel All Documents** in the **Printer** menu.

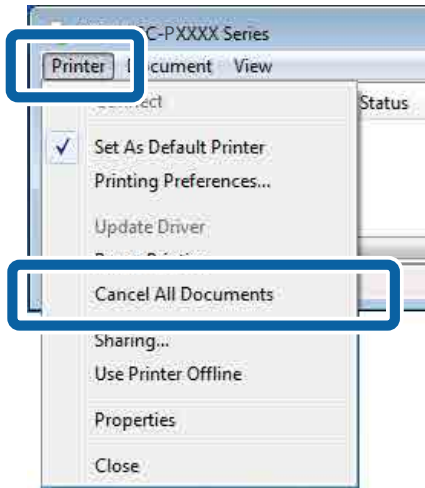

If the job has been sent to the printer, print data is not displayed on the above screen.

Canceling Printing (Mac)

When the computer has finished sending data to the printer, you cannot cancel the print job from the computer. Cancel on the printer.

[“Canceling Printing \(from the Printer\)” on page 57](#)

- 1 Click the printer icon in the Dock.



- 2 Select the job you want to cancel, and then click **Delete**.

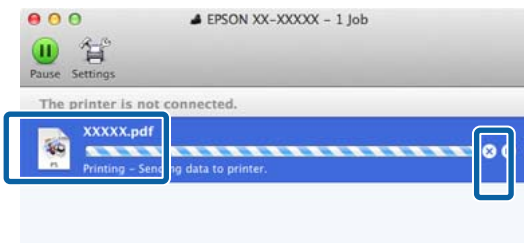

If the job has been sent to the printer, print data is not displayed on the above screen.

Canceling Printing (from the Printer)

The Cancel button is displayed on the control panel screen during printing. Touch the Cancel button. The print job is canceled even in the middle of printing. It may take a while before the printer returns to the ready status.

Note:

Note: You cannot delete print jobs which are in the print queue on the computer using the above operation. See "Canceling Printing (Windows)" or "Canceling Printing (Mac)" in the previous section for information on deleting print jobs from the print queue.

Basic Operations

Printable area

This section describes the printable areas for the printer.

If the margin set in an application is larger than the following setting values, sections beyond the specified margins are not printed. For example, if 15 mm is selected for the left and right margins in the printer menus and the document fills the page, the 15 mm at the left and right sides of the page will not be printed.

If the margin at the leading edge of the paper is small, colors may be uneven depending on the paper and printing environment. If this occurs, print a larger margin at the leading edge of the paper.

Roll Paper Printable Area

The gray area in the illustration below shows the printable area.

The arrow in the illustration indicates the direction of the ejected paper.

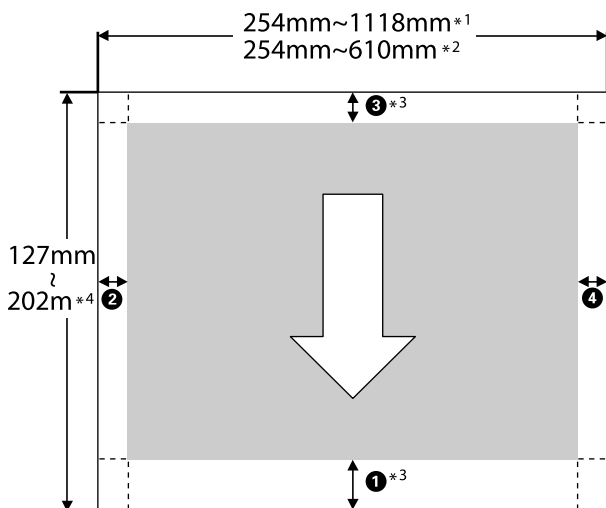

- *1 SC-P9500 Series
- *2 SC-P7500 Series
- *3 Selecting **Roll Paper (Banner)** from **Source** in the printer driver sets the top and bottom margins of the paper to 0 mm.

*4 The printer driver supports the following maximum paper lengths.

Windows: 18 m (708.66 inch)

Mac: 18 m (708.66 inch)

When printing on paper longer than this, you need commercially available banner printing software. In this situation, select **Roll Paper (Banner)** from **Source** in the printer driver.

① to ④ in the illustration indicates the margins at the top, bottom, left, and right.

For borderless printing, the following values are set to 0 mm.

- Left and right borderless printing: ②, ④
- Borderless printing on all sides: ①, ②, ③, ④

Margins in other situations depend on the options selected for **Top Margin/Bottom Margin** in the menus.

Settings for Top Margin/Bottom Margin

["Paper Setting" on page 111](#)

indicates factory default settings.

Setting values for Top Margin/Bottom Margin	Margin Values
Standard	①, ③ = 15 mm*
	②, ④ = 3 mm

* When **Standard** is selected, the value for ① is 20 mm for the following paper.

Premium Glossy Photo Paper (250)/Premium Semigloss Photo Paper (250)/Premium Luster Photo Paper (260)/Premium Semimatte Photo Paper (260)

Basic Operations

Also, when using UltraSmooth Fine Art paper/baryta, the value for ❶ is 45 mm.

When you want to change the margins, make changes in **Top Margin** and **Bottom Margin** from **Paper Setting**.

You can select from 3 mm, 15 mm, 20 mm, and 45 mm for **Top Margin** to change the length of ❶.

You can select from 3 mm and 15 mm for **Bottom Margin** to change the length of ❸.

Important:

- ❑ *Printing is distorted when the trailing edge of the roll paper comes off the core. Make sure the trailing edge does not come inside the printing area.*
- ❑ *The print size does not change even when the margins are changed.*

Note:

When printing using Black Enhance Overcoat, a maximum margin of approximately 34 mm is added. When printing using Black Enhance Overcoat, select Minimize Top Margin to adjust the margins.

See the following for more details.

 ["Printing with Darker Tones of Black \(Black Enhance Overcoat\)" on page 74](#)

When printing multiple pages without using auto cut, the margins between pages such as the first and second page use the value set in the Margin Between Pages menu.

 ["Paper Setting" on page 111](#)

Cut Sheets Printable Area

The gray area in the illustration below shows the printable area. The arrow in the illustration indicates the direction of the ejected paper.

When printing borderless on the left and right, the left and right margins are 0 mm.

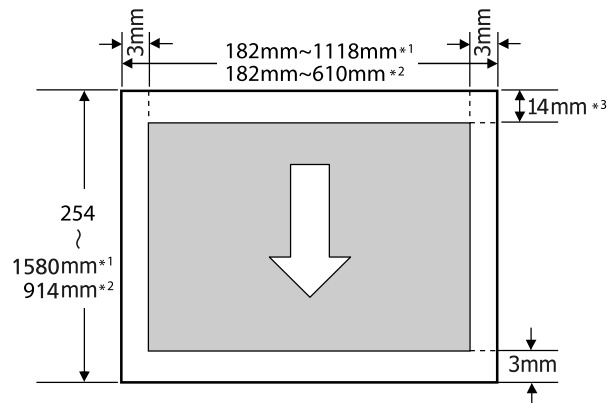

*1 SC-P9500 Series

*2 SC-P7500 Series

*3 15.5 mm when printing Enhanced Matte Poster Board

Turning Off the Power Using Power Off Timer

The printer offers the following two power management options.

Saving Power

The printer enters sleep mode or turns off automatically if no operations are performed for a set period. You can adjust the time before power management is applied.

Any increase will affect the product's energy efficiency. Please consider the environment before making any changes.

Sleep mode

The printer enters sleep mode when there are no errors, no print jobs being received, and no control panel or other operations performed. When the printer enters sleep mode, the control panel's screen turns off and the internal motors and other parts switch off to consume less power.

Sleep mode is cleared if a print job is received or a button on the control panel is pressed.

You can set the time before entering sleep mode from 1 to 60 minutes. By default, the printer enters sleep mode if no operations are performed for 5 minutes. You can change the **Sleep Timer** in "General Settings".

 ["General Settings" on page 116](#)

Note:

When the printer enters sleep mode, the control panel's screen goes blank as if the power has been turned off, but the power light remains on.

Power Off Timer

The printer is equipped with a Power Off Timer option that automatically turns the printer off if no errors occur, no print jobs are received, and no control panel or other operations are performed for a set period of time. You can set the time until the printer automatically turns off from 30 minutes to 12 hours.

The factory default setting is **Off**. You can set **Power Off Timer** from the "General Settings" menu.

 ["General Settings" on page 116](#)

Using the Optional Hard Disk Unit

Using the Optional Hard Disk Unit

Function Summary

When an optional hard disk unit or Adobe® PostScript® 3™ expansion unit (from now on, hard disk) is installed, you can save print jobs and then reprint them.

Extended functions

Print jobs can be viewed and managed as described below.

Viewing Print Jobs

When there are multiple print jobs with some in the queue, the following information can be displayed.

- Estimated print start time
- Estimated print time

Viewing and Resuming Held Print Jobs

If the source or other settings selected with the printer differ from the settings specified in the print job, an error will occur and printing will be suspended.

When an error occurs, printing cannot be restarted until the printer has been readied by, for example, replacing the paper.

However, the following types of print job can be held temporarily on the hard disk.

Therefore, after printing all the jobs that can be printed with the current paper, you can replace the paper with the media specified in the held print jobs and resume printing, making your work more efficient.

- Print jobs that specify sources that differ from that selected with the printer
- Print jobs that specify paper types that differ from that selected with the printer

- Print jobs that specify output paper sizes (widths) that are larger than that selected with the printer

Note:

You can set held jobs in **General Settings - Printer Settings - PS3 Menu - Store Held Job**.

 [“General Settings” on page 116](#)

Viewing and Printing Stored Jobs

Print jobs can be stored on the hard disk and printed at a later date.

Print jobs selected for printing at a later date can be printed directly on the hard disk without increasing the load on your computer.

Print jobs are saved using the printer driver.

 [“Saving Print Jobs” on page 62](#)

Note:

Jobs printed with the following applications are always saved to the hard disk.

LFP Print Plug-In for Office

Print Job Management

From the print job menu on the control panel

Detailed procedure

 [“Viewing and Printing Saved Print Jobs” on page 63](#)

Data on a Hard Disk

Data on a hard disk cannot be copied to a computer or other device. Even when print jobs have been stored on the hard disk, save the original data on a computer.

Data on a hard disk may be lost or corrupted in the following situations.

- When the disk is affected by static electricity or electrical noise
- When the disk has been used incorrectly
- After a malfunction or repair

Using the Optional Hard Disk Unit

- ❑ When the disk was damaged by a natural disaster

We take no responsibility for any data loss, data corruption, or other problems due to any cause, even including those listed above and within the warranty period. Be aware that we are also not responsible for the recovery of lost or corrupted data.

Saving Print Jobs

This section describes the printer driver settings used to save print jobs.

Settings on Windows

- 1 When you have created the data, click **Print** in the **File** menu.

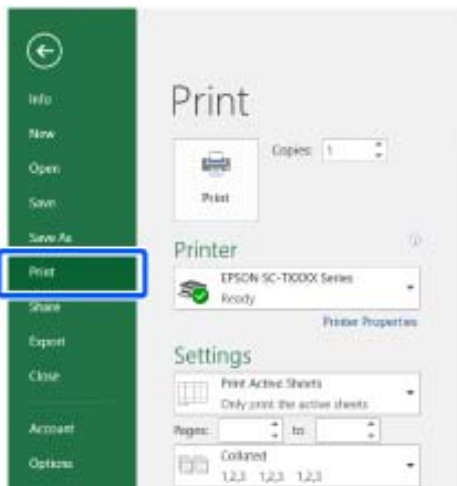

- 2 After confirming that the printer is selected, click **Printer properties** or **Properties** to display printer settings.



- 3 On the Layout screen, click the **Settings** button from Hard Disk Unit, and then select **Print Job**.

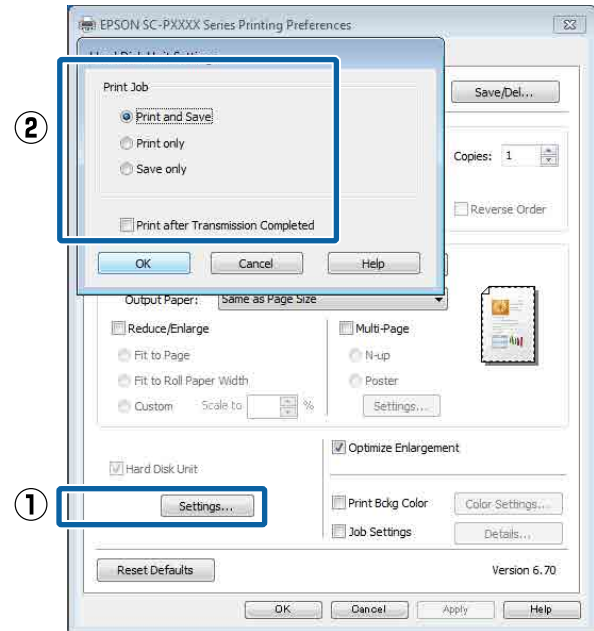

Print operations differ depending on the selected content as shown below.

- ❑ **Print and Save:**
Saves the job to the hard disk at the same time as printing. When **Print after Transmission Completed** is selected, printing starts after the print job has been saved to the hard disk unit.
- ❑ **Print only:**
Prints the job without saving to the hard disk.
- ❑ **Save only:**
Saves the job to the hard disk without printing.

Next, print the document normally.

Using the Optional Hard Disk Unit

Settings in Mac

- 1 When you have created the data, from the File menu of the application, click **Print** and so on.

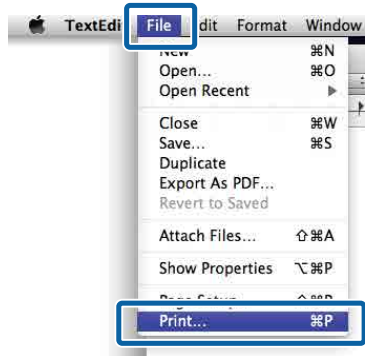

- 2 Check that the printer is selected, and then select **Hard Disk Unit Settings** from the list.

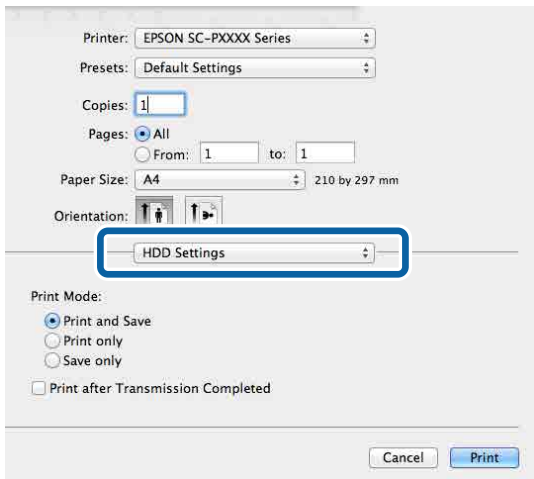

- 3 Select **Print Job**.

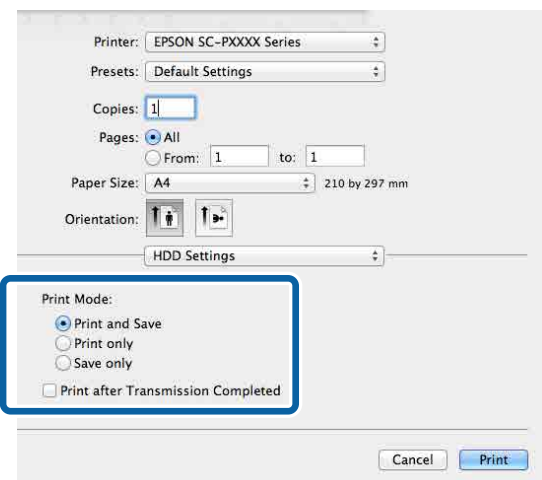

After clicking **Print**, the operations differ depending on the selected content as shown below.

- Print and Save:**
Saves the job to the hard disk at the same time as printing. When **Print after Transmission Completed** is selected, printing starts after the print job has been saved to the hard disk unit.
- Print only:**
Prints the job without saving to the hard disk.
- Save only:**
Saves the job to the hard disk without printing.

Next, print the document normally.

Viewing and Printing Saved Print Jobs

This section describes how to view and print saved jobs from the control panel.

- 1 Touch Information on the control panel.

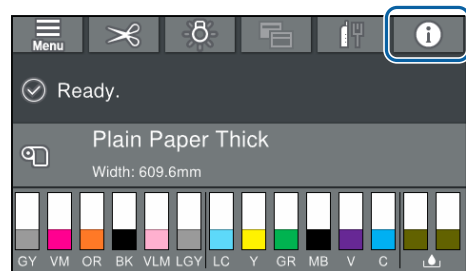

- 2 Touch Job Status, and then select Save.
Jobs saved on the hard disk are displayed.

- 3 Select a job, and then follow the on-screen instructions to print or delete.

Using the Printer Driver(Windows)

Using the Printer Driver (Windows)

Displaying the Settings Screen

You can access the printer driver in the following ways:

- ❑ From Windows applications
 "Printing (Windows)" on page 53
- ❑ With the Start button

With the Start button

Follow the steps below when specifying common settings among applications or performing printer maintenance, such as Nozzle Check or Head Cleaning.

- 1 On the **Control Panel** click **Hardware and Sound** and then **View devices and printers**.

Windows 10/8.1/8/7

Click in the following order: **Hardware and Sound** (or **Hardware**) > **View devices and printers** (or **Devices and Printers**).

For Windows Vista

Click , **Control Panel**, **Hardware and Sound**, and then **Printer**.

For Windows XP

Click **Start**, **Control Panel**, **Printers and Other Hardware**, and then **Printers and Faxes**.

Note:

If your Windows XP Control Panel is in **Classic View**, click **Start**, **Control Panel**, and then **Printers and Faxes**.

- 2 Right-click your printer icon, and click **Printing preferences**.

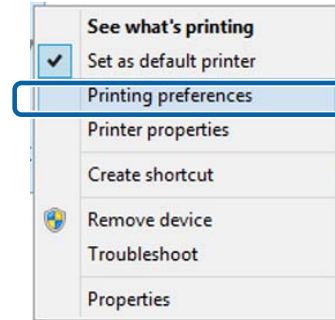

The printer driver setting screen is displayed.

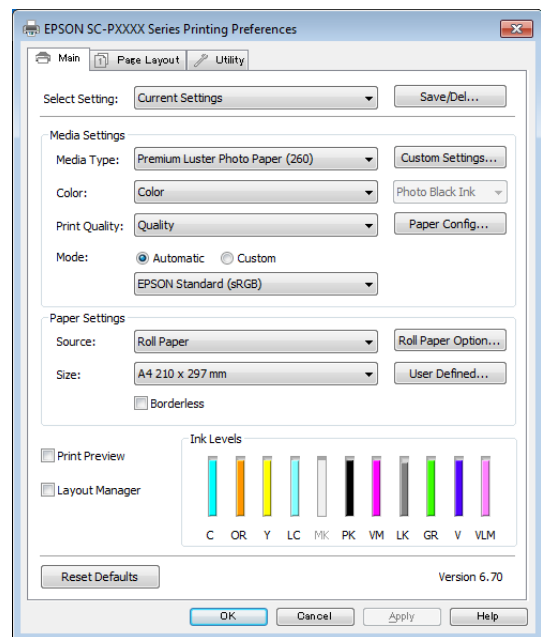

Make the necessary settings. These settings become the default settings of the printer driver.

Using the Printer Driver(Windows)

Displaying Help

You can access the printer driver help in the following ways:

- ❑ Click **Help**
- ❑ Right-click on the item you want to check and display

Click the Help Button to Display

By displaying help, you can use the contents page or keyword search to read the help.

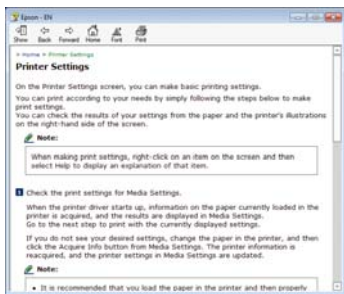
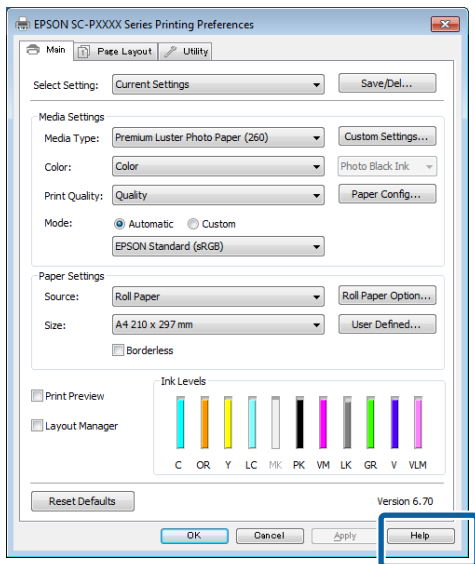

Right-click on the item you want to check and display

Right-click the item, and then click **Help**.

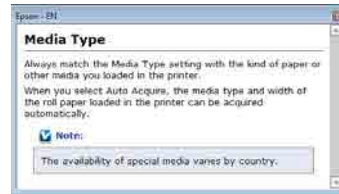
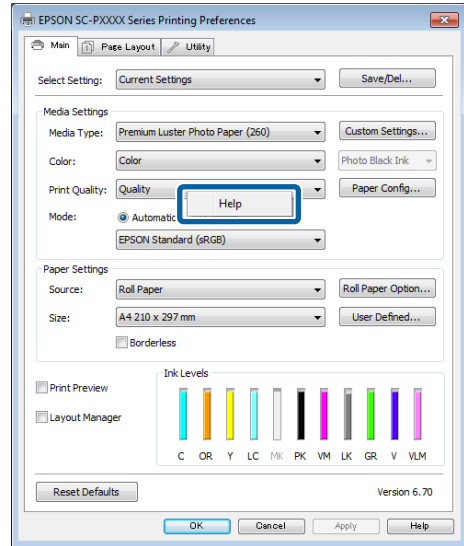

Note:

In Windows XP, click  on the title bar, and then click the help item you want to view.

Using the Printer Driver(Windows)

Customizing the Printer Driver

You can save the settings or change the display items as you prefer.

Saving various settings as your Select Settings

You can save all printer driver settings as a Select Setting. Additionally, in Select Setting the recommended settings for a variety of uses are already available.

This allows you to easily load settings that have been stored in Select Settings, and repeatedly print using exactly the same settings.

- 1 Set each item for the **Main** screen and the **Layout** screen that you want to save as your Select Settings.
- 2 Click **Save/Delete** in the **Main** or **Layout** tab.

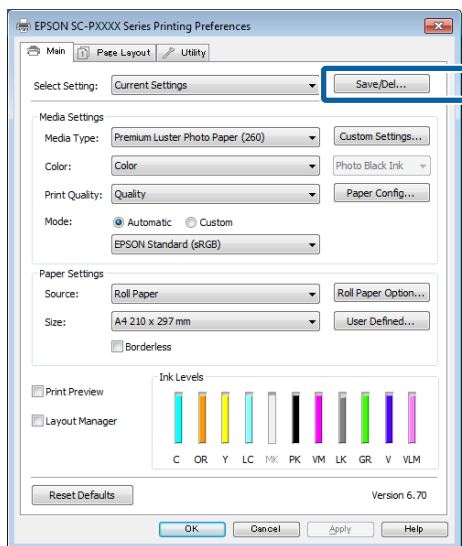

- 3 When you enter a name in **Name** and click **Save**, the settings are saved in **List**.

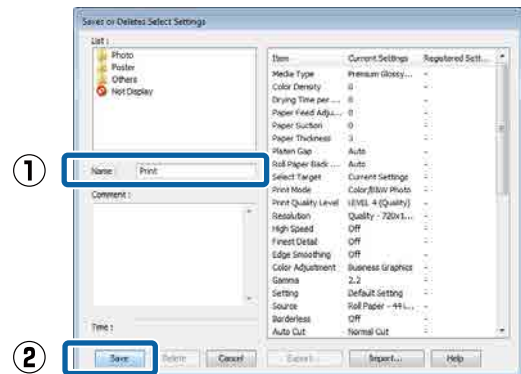

You can load the settings you have saved from **Select Setting** on the **Main** screen.

Note:

- You can save up to 100 settings.
- Select the settings you want to save, and then click **Export** to save them to a file. You can share the settings by clicking **Import** to import the saved file on another computer.
- Select the settings you want to delete, and then click **Delete**.

Adjusting the Ink Density

You can adjust the ink density according to the paper you are using and you can register the settings.

- 1 Display the printer driver's **Main** screen.
[☞ "Printing \(Windows\)" on page 53](#)

Using the Printer Driver(Windows)

- 2** Select **Media Type**, and then click **Paper Configuration**.

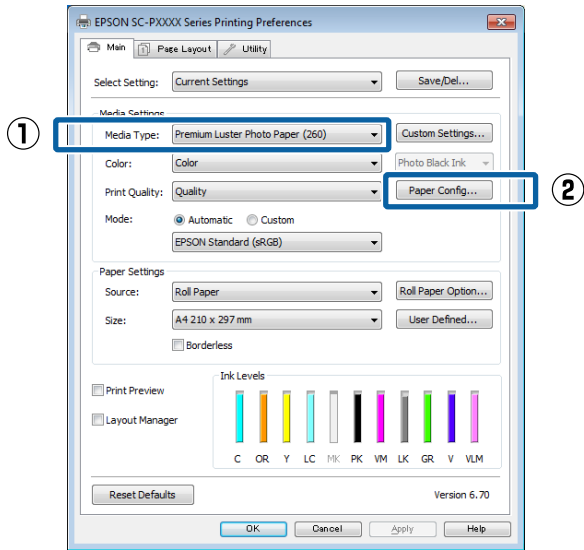

- 3** Set the ink density according to the paper you want to register, and then click **OK**.

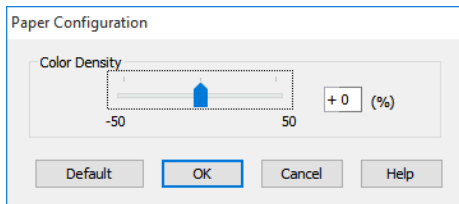

- 4** Click **Custom Settings**.

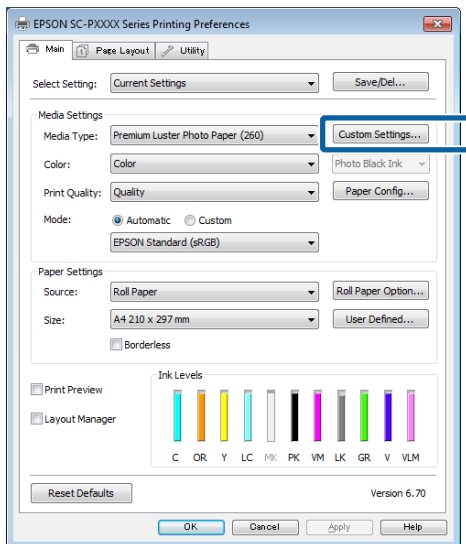

- 5** When you enter a name in **Name** and click **Save**, the settings are saved in **List**.

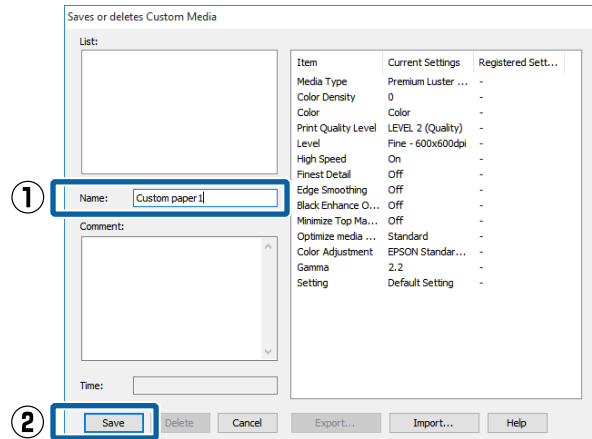

You can select saved settings from **Media Type** on the Main screen.

Note:

- You can save up to 100 settings.
- Select the settings you want to save, and then click **Export** to save them to a file. You can share the settings by clicking **Import** to import the saved file on another computer.
- Select the settings you want to delete, and then click **Delete**.

Rearranging display items

To display frequently used items right away, you can arrange **Select Setting**, **Media Type**, and **Paper Size** as follows.

- Hide unnecessary items.
- Rearrange in an order of most frequent use.
- Arrange in groups (folders).

Using the Printer Driver(Windows)

- 1 Go to the **Utility** tab and click **Menu Arrangement**.

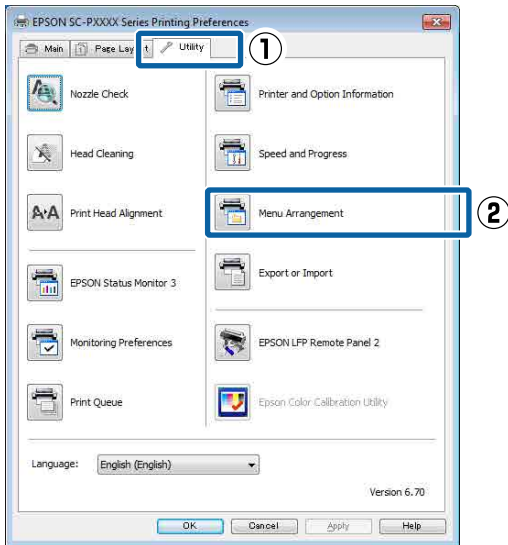

- 2 Select **Edit Item**.

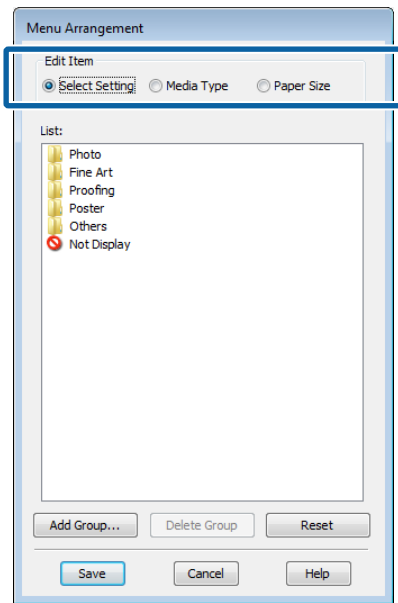

- 3 Order or group items in the **List** box.

- You can move and order items by dragging and dropping.
- To add a new group (folder), click **Add Group**.
- To delete a group (folder), click **Delete Group**.

- Drag and drop unnecessary items to **Not Display**.

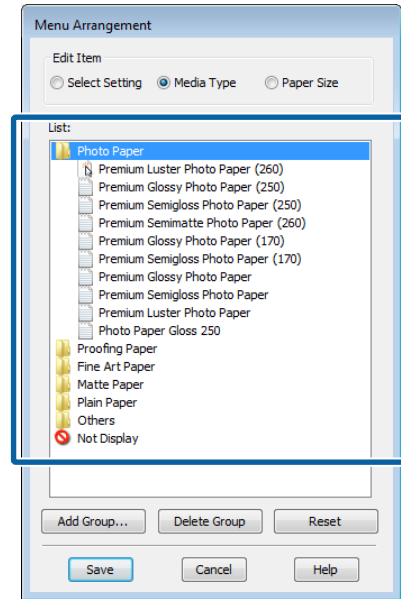

Note:
 When **Delete Group** is performed, the group (folder) is deleted, however the settings in the deleted group (folder) remain. You also need to delete individually from **List** in the save location.

- 4 Click **Save**.

Using the Printer Driver(Windows)

Summary of the Utility Tab

You can perform the following maintenance functions from the printer driver's **Utility** tab.

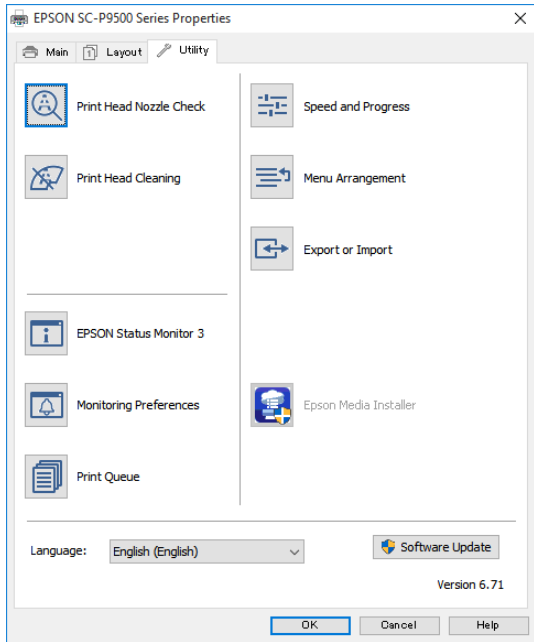

Print Head Nozzle Check

This function prints a nozzle check pattern to check if the print head nozzles are clogged.

If you see banding or gaps in the print outs, perform head cleaning to clear any clogged nozzles.

[“Print Head Nozzle Check” on page 125](#)

Cleaning the print head

If you see banding or gaps in the print outs, perform head cleaning. Cleans the surface of the print head to improve the print quality.

[“Cleaning the print head” on page 127](#)

EPSON Status Monitor 3

You can check the printer's status, such as the remaining ink level and error messages, on the computer's screen.

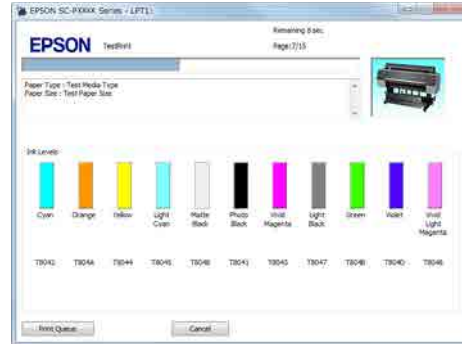

Monitoring Preferences

You can select the error notifications displayed on the EPSON Status Monitor 3 screen, or register a shortcut for the Utility icon to the Taskbar.

Note:

*If you select the **Shortcut Icon** on the **Monitoring Preferences** screen, the **Utility shortcut icon** is displayed on the **Windows Taskbar**.*

By right-clicking the icon, you can display the following menu and perform maintenance functions.

EPSON Status Monitor 3 starts when the printer name is clicked from the displayed menu.

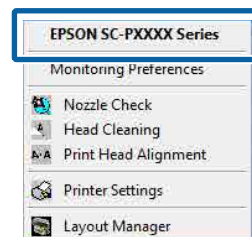

Print Queue

You can display the list of all waiting jobs.

On the Print Queue screen, you can view information on the data waiting to be printed, delete and reprint these jobs.

Printer and Option Information

Displays the inkset information. These settings should not normally be changed.

Using the Printer Driver(Windows)

If you cannot acquire inkset information automatically, select an inkset according to the ink type that is installed in the printer.

Speed and Progress

You can set various functions for printer driver basic operations.

Menu Arrangement

You can arrange the display items of **Select Setting**, **Media Type**, and **Paper Size**. For example, you can reord them by frequency of access.

 [“Rearranging display items” on page 67](#)

Export or Import

You can export or import the printer driver settings. This function is useful when you want to make the same printer driver settings on multiple computers.

Epson Media Installer

If the paper information you want to use is not displayed on the control panel or in the driver, you can add paper information from the Internet.

 [“Using Epson Media Installer” on page 19](#)

Using the Printer Driver (Mac)

Using the Printer Driver (Mac)

Displaying the Settings Screen

The display method of the printer driver setting screen may differ depending on the application or the OS version.

[“Performing Printing \(Mac\)” on page 54](#)

Displaying Help

Click in the printer driver setting screen to display Help.

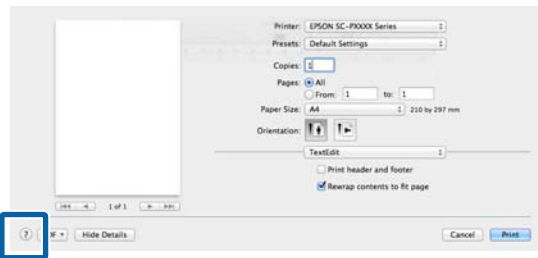

Using Presets

You can adjust the ink density according to the paper you are using and you can save the settings.

Saving to Presets

1 Set each item in Paper Size and Print Settings that you want to save to the preset.

Select **Paper Configuration** from the list, and then set the ink density according to the paper you want to use.

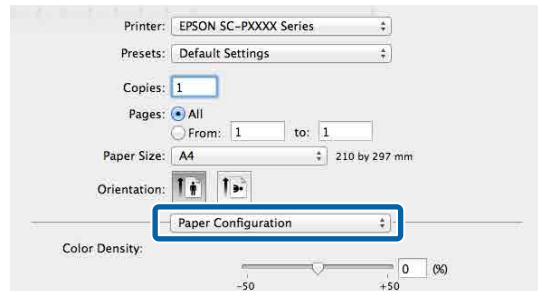

2 Click **Save Current Settings as Preset...** from **Presets**.

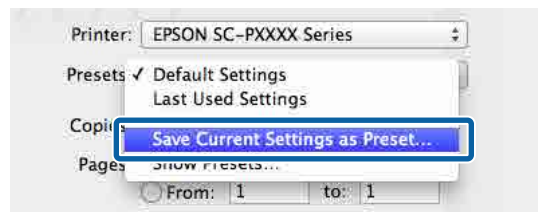

3 Enter a name, and then click **OK**.

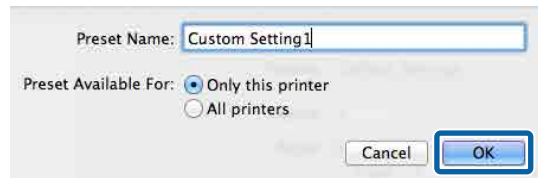

Note:
When **All printers** is selected from **Preset Available For**, you can select the saved Preset from all printer drivers installed on your computer.

The settings are saved to **Presets**.

You can then select the settings you saved from **Presets**.

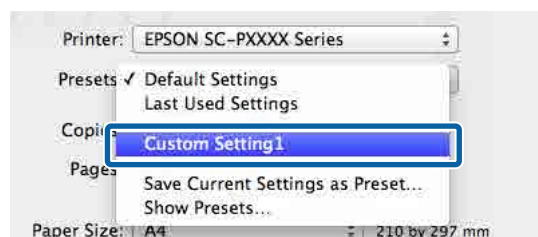

Using the Printer Driver (Mac)

Deleting from Presets

- 1 Click **Show Presets...** in **Presets** of the Print dialog box.

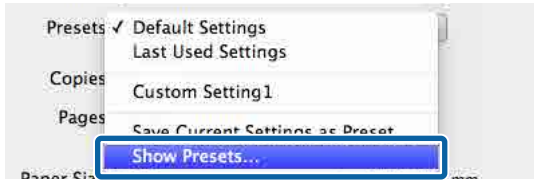

- 2 Select the setting you want to delete, click **Delete**, and then click **OK**.

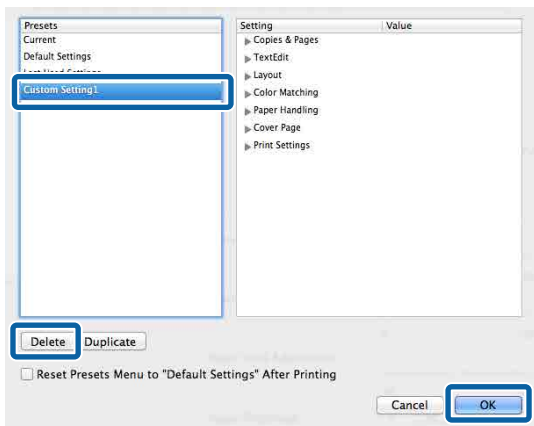

Using Epson Printer Utility 4

You can perform maintenance tasks such as Nozzle Check or Head Cleaning by using Epson Printer Utility 4. This utility is installed automatically when you install the printer driver.

Starting Epson Printer Utility 4

- 1 Click the Apple menu - **System Preferences** - **Printers & Scanners** (or **Print & Fax**).
- 2 Select the printer and click **Options & Supplies** > **Utility** > **Open Printer Utility**.

Epson Printer Utility 4 Functions

You can perform the following maintenance functions from Epson Printer Utility 4.

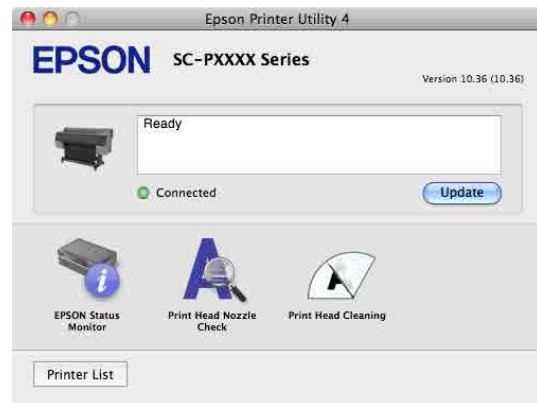

Using the Printer Driver (Mac)

EPSON Status Monitor

You can check the printer's status, such as the remaining ink level and error messages, on the computer's screen.

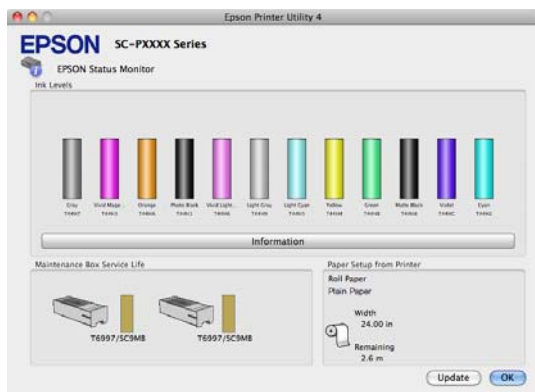

Print Head Nozzle Check

This function prints a nozzle check pattern to check if the print head nozzles are clogged.

If you see banding or gaps in the print outs, perform head cleaning to clear any clogged nozzles.

 [“Print Head Nozzle Check” on page 125](#)

Cleaning the print head

If you see banding or gaps in the print outs, perform head cleaning. Cleans the surface of the print head to improve the print quality.

 [“Cleaning the print head” on page 127](#)

Printing Varieties

Printing Varieties

Printing with Darker Tones of Black (Black Enhance Overcoat)

Black Enhance Overcoat is a function that improves the dynamic range by increasing the maximum density of black by using Light Gray ink to overcoat dark and gray areas in the prints.

Black Enhance Overcoat can only be used on glossy paper. However, this cannot be used for some glossy paper.

Note:

Black Enhance Overcoat may not be available depending on the paper being used.

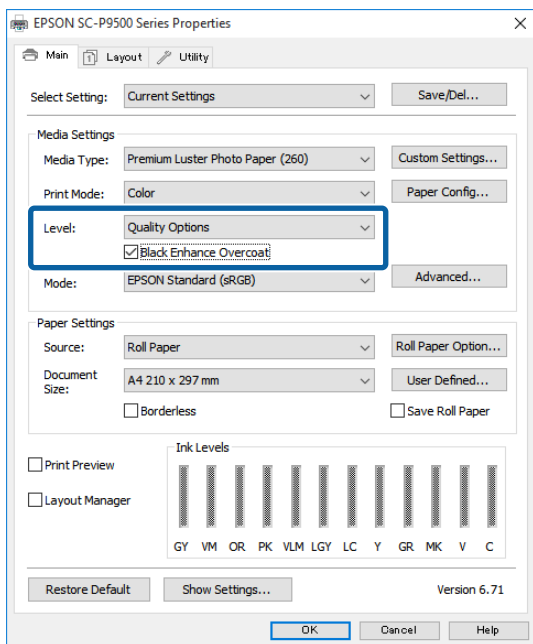

When **Black Enhance Overcoat** is selected, a larger margin is printed at the edge of the paper. Selecting **Minimize Top Margin** reduces the margins at the edge of the paper, but also lowers the image quality at these reduced margins.

For Minimize Top Margin, set **Print Quality** to **Quality Options**, and then set in **Quality Options**.

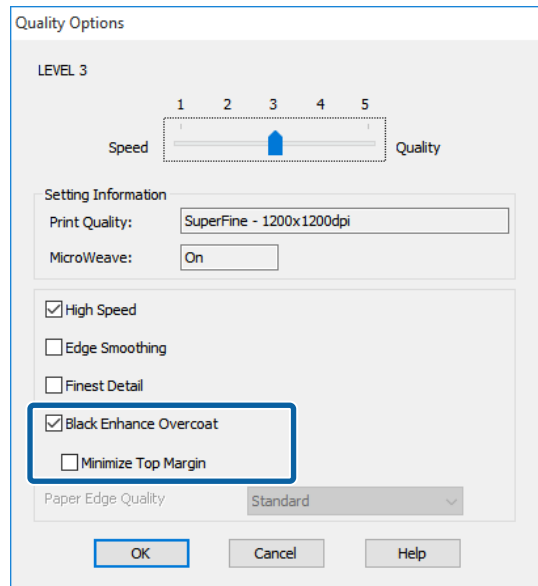

Important:

*If you select **Reduce Edge Margins** for paper that curls easily, the paper may rub against the print head.*

Correct color and print

The printer driver automatically and internally corrects colors to match the color space. You can select from the following color correction modes.

- EPSON Standard (sRGB)
Optimizes the sRGB space and corrects the color.
- Adobe RGB
Adobe RGB Optimizes the sRGB space and corrects the color.

Note that if you click **Settings** when one of the above color processing options is selected, you can fine-tune Gamma, Brightness, Contrast, Saturation, and color balance for the selected option.

Use this option when the application in use does not have a color correction function.

Printing Varieties

Making Settings in Windows

1 When using applications featuring a color management function, specify how to adjust colors from these applications.

When using applications without a color management function, start from step 2.

Depending on the type of the application, make the settings following the table below.

Adobe Photoshop CS3 or later
 Adobe Photoshop Elements 6.0 or later
 Adobe Photoshop Lightroom 1 or later

OS	Color Management Settings
Windows 10, Windows 8.1, Windows 8, Windows 7, Windows Vista	Printer Manages Colors
Windows XP (Service Pack 2 or later and .NET 3.0 or later)	Printer Manages Colors
Windows XP (other than the above)	No Color Management

In other applications, set **No Color Management**.

Note:
 For information on supported platforms, see the website for the application in question.

Setting example for Adobe Photoshop CC

Open the **Print** screen.

Select **Color Management**, then select **Printer Manages Colors** in **Color Handling**, and click **Print**.

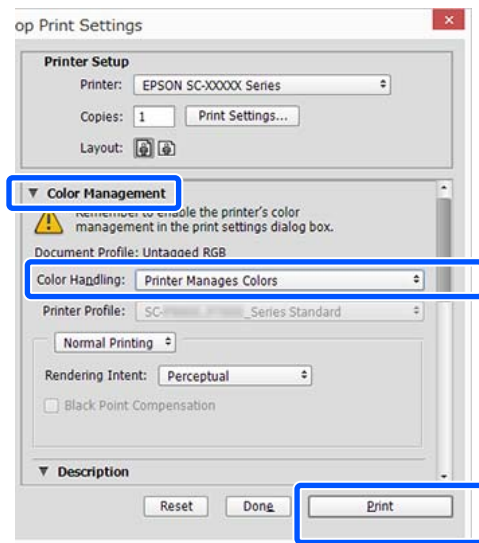

2 Display the printer driver's **Main** screen.

[“Printing \(Windows\)” on page 53](#)

3 Select **Specify Size** from **Mode**, and then select **Color Controls**.

To make more detailed adjustments, click **Settings**, and then proceed to Step 4.

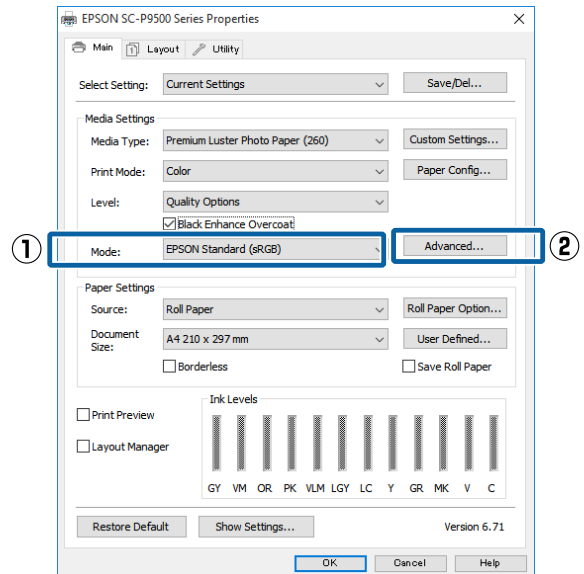

Printing Varieties

- Make the necessary settings.
See the printer driver help for more details on each item.

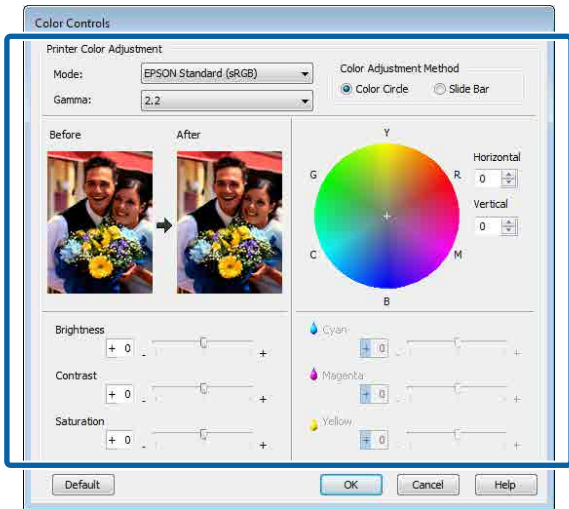

Note:

You can adjust the correction value by checking the sample image on the left side of the screen. You can also use the color circle to fine-tune the color balance.

- Check other settings, and then start printing.

Settings in Mac

- When using applications featuring a color management function, specify how to adjust colors from these applications.

When using applications without a color management function, start from Step 2.

When using the following applications, select the **Printer Manages Colors** color management option.

Adobe Photoshop CS3 or later
 Adobe Photoshop Elements 6 or later
 Adobe Photoshop Lightroom 1 or later

In other applications, set **No Color Management**.

Note:

For information on supported platforms, see the website for the application in question.

Setting example for Adobe Photoshop CC

Open the **Print** screen.

Select **Color Management**, then select **Printer Manages Colors** in **Color Handling**, and click **Print**.

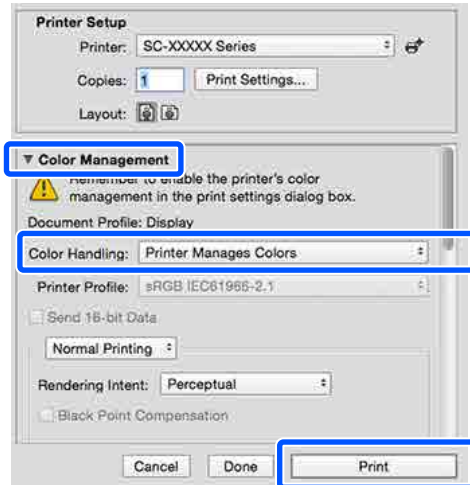

- Display the Print screen.
[“Performing Printing \(Mac\)”](#) on page 54

- Select **Color Matching** from the list, and then click **EPSON Color Controls**.



Note:

EPSON Color Controls will not be available in the following applications if Step 1 is omitted.

- Adobe Photoshop CS3 or later
- Adobe Photoshop Lightroom 1 or later
- Adobe Photoshop Elements 6 or later

Printing Varieties

- 4** Select **Main** from the list and then clear the **Simple Settings** check box in the **Print Quality** area.

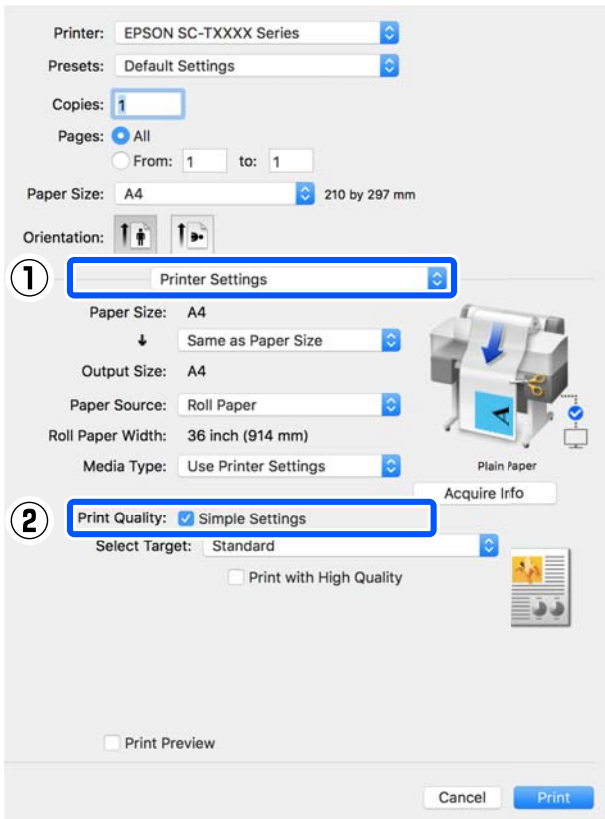

- 5** Select the print target. If you want to select the color correction method yourself, select **Custom** at the very bottom of the list.

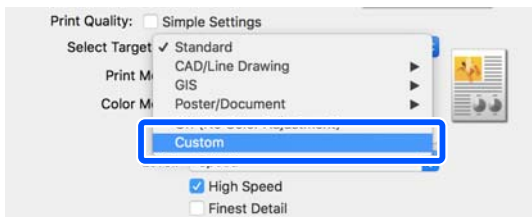

- 6** When **Custom** is selected for the print target, select the color and color correction method settings.

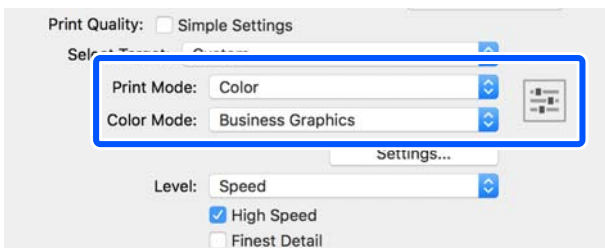

- 7** If necessary, click **Settings** and then adjust items such as the Gamma, Brightness, Contrast, Saturation, and color balance.

See the printer driver help for more details on each item.

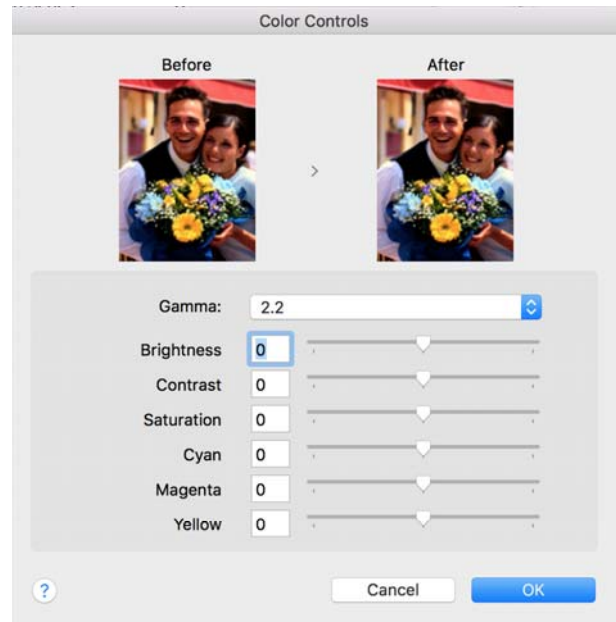

- 8** Check other settings, and then start printing.

Printing Varieties

Printing Black and White Photos

You can print black and white photos with rich gradation by adjusting the image data color by the printer driver. You can correct image data when printing without processing the data from applications. The original data is not affected.

You cannot select **Advanced B&W Photo** in the following instances. When printing in black and white, select **Black** (Windows) or **Grayscale** (Mac).

- ❑ When using Singleweight Matte Paper, Photo Quality Ink Jet Paper, or Plain Paper

Note:
It is recommended that you use images with a color space of sRGB.

Making Settings in Windows

- 1 When using applications featuring a color management function, specify how to adjust colors from these applications.

When using applications without a color management function, start from step 2.

Depending on the type of the application, make the settings following the table below.

Adobe Photoshop CS3 or later
 Adobe Photoshop Elements 6.0 or later
 Adobe Photoshop Lightroom 1 or later

OS	Color Management Settings
Windows 10, Windows 8.1, Windows 8, Windows 7, Windows Vista	Printer Manages Colors
Windows XP (Service Pack 2 or later and .NET 3.0 or later)	Printer Manages Colors
Windows XP (other than the above)	No Color Management

In other applications, set **No Color Management**.

Note:
For information on supported platforms, see the website for the application in question.

Setting example for Adobe Photoshop CC

Open the **Print** screen.

Select **Color Management**, then select **Printer Manages Colors** in **Color Handling**, and click **Print**.

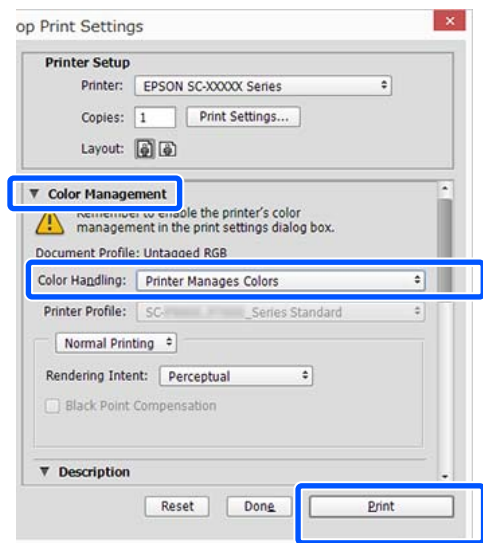

- 2 Display the printer driver's **Main** screen.

["Printing \(Windows\)" on page 53](#)

- 3 Select **Color** from **Advanced B&W Photo**.

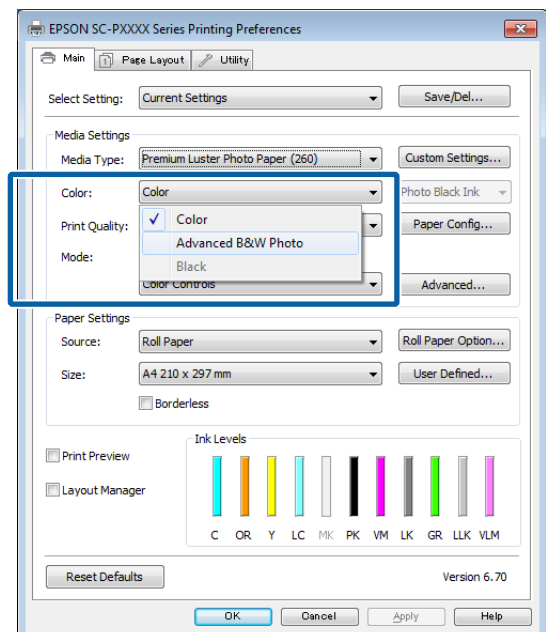

Printing Varieties

To make detailed adjustments, proceed to Step 4. If you do not want to make adjustments, proceed to Step 6.

4 Click **Settings in Mode**.

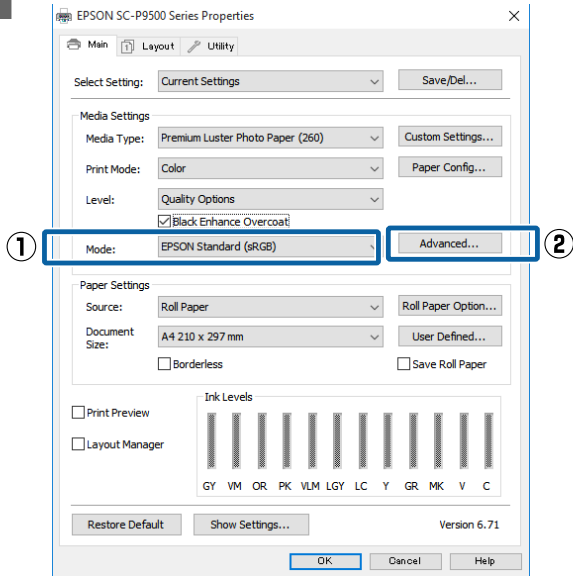

5 Make the necessary settings. See the printer driver help for more details on each item.

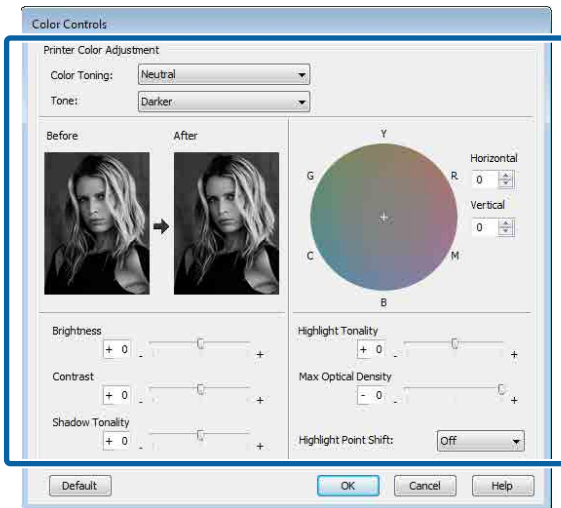

6 Check other settings, and then start printing.

Settings in Mac

1 When using applications featuring a color management function, specify how to adjust colors from these applications.

When using the following applications, select the **Printer Manages Colors** color management option.

- Adobe Photoshop CS3 or later
- Adobe Photoshop Elements 6 or later
- Adobe Photoshop Lightroom 1 or later

In other applications, set **No Color Management**.

Note:
For information on supported platforms, see the website for the application in question.

Setting example for Adobe Photoshop CC

Open the **Print** screen.

Select **Color Management**, then select **Printer Manages Colors** in **Color Handling**, and click **Print**.

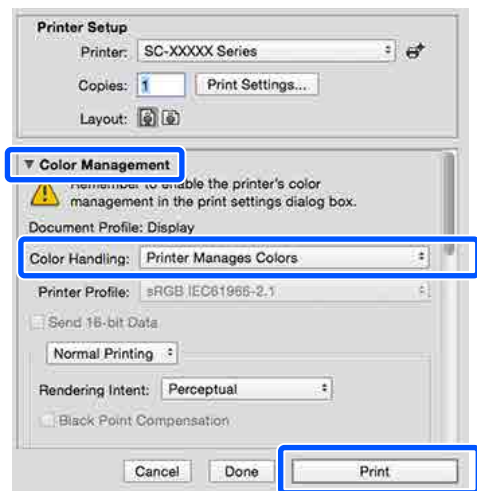

Printing Varieties

- 2 Display the Print screen, select **Print Settings** from the list, and then select **Advanced B&W Photo** as the **Color**.

 "Performing Printing (Mac)" on page 54

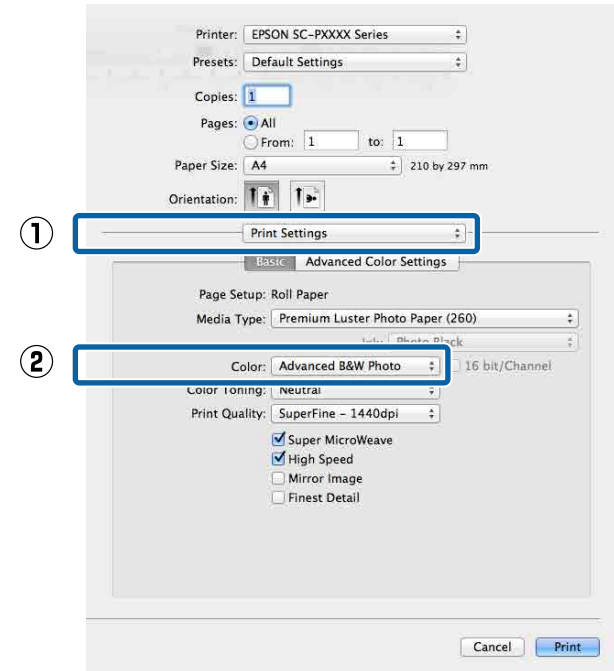

- 3 Click **Advanced Color Settings**.

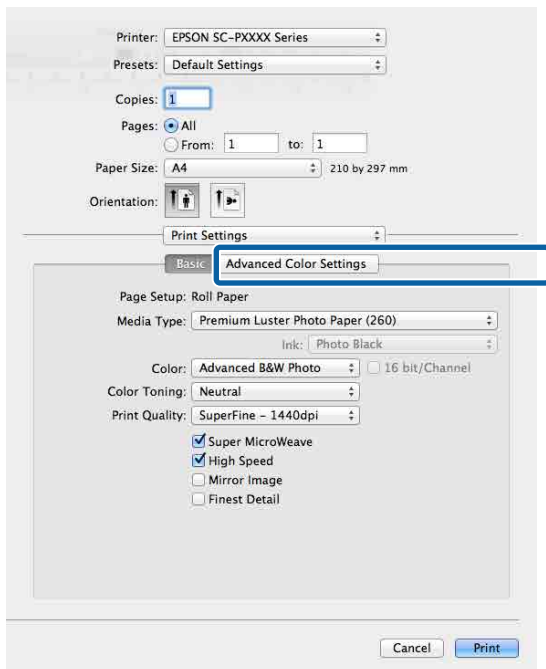

- 4 Make the necessary settings.
See the printer driver help for more details on each item.

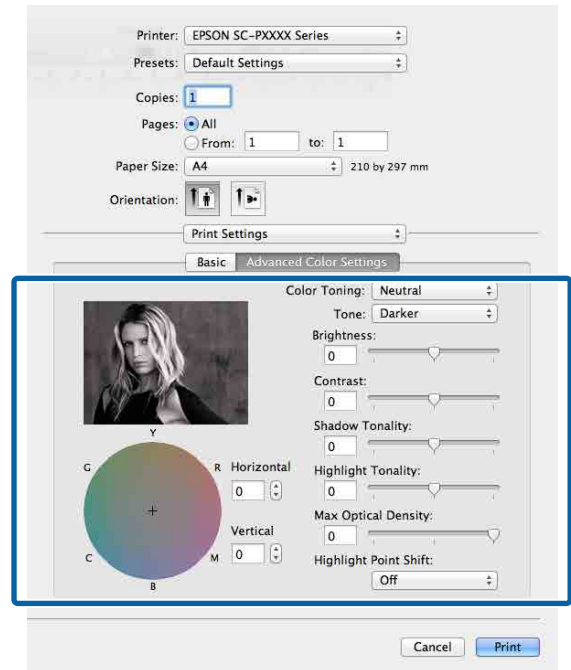

- 5 Check other settings, and then start printing.

Printing Varieties

Borderless Printing

You can print your data without margins on the paper.

The types of borderless printing you can choose vary as shown below depending on the media type.

Roll Paper: No margins for all edges, no margins for the left and right

Cut Sheets: No margins for the left and right only

(Borderless printing is not available with poster board.)

When printing borderless for all edges, you can also configure the cutting operation.

 [“About Roll Paper Cutting” on page 82](#)

When performing left and right borderless printing, margins appear on the top and bottom of the paper.

Top and bottom margin values

 [“Printable area” on page 58](#)

Types of Borderless Printing Methods

You can perform borderless printing using the following two methods.

Auto Expand

The printer driver enlarges the print data to a size slightly larger than the paper size and prints the enlarged image. The sections which are beyond the paper edges are not printed; therefore, resulting in borderless printing.

Use settings such as Page Setup in the applications to set the size of the image data as follows.

- Match the paper size and page setting for the print data.
- If the application has margin settings, set the margins to 0 mm.
- Make the image data as large as the paper size.

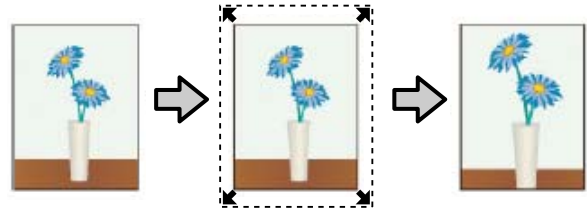

Retain Size

Create the print data larger than the paper size in the applications to produce borderless output. The printer driver does not enlarge the image data.

Use settings such as Page Setup in the applications to set the size of the image data as follows.

- Create print data larger than its actual print size by 3 mm on the left and right (6 mm in total).
- If the application has margin settings, set the margins to 0 mm.
- Make the image data as large as the paper size.

Select this setting if you want to avoid image enlargement by the printer driver.

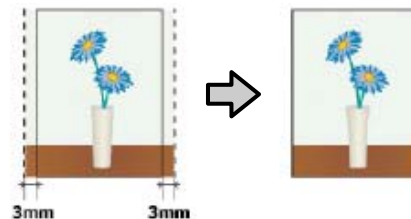

Supported Paper

Depending on the media type or size, the print quality may decline or borderless printing cannot be selected.

 [“Epson Special Media Table” on page 168](#)

 [“Supported Commercially Available Paper” on page 179](#)

Printing Varieties

About Roll Paper Cutting

When performing borderless printing on roll paper, you can specify whether it is left and right borderless printing or all edges borderless printing, and how to cut the paper in the printer driver's **Roll Paper Option**. The cutting operation for each value is shown in the following chart.

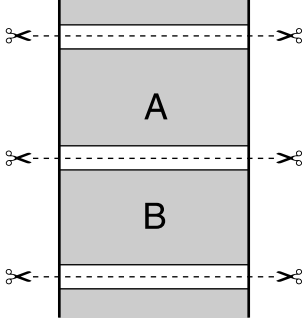
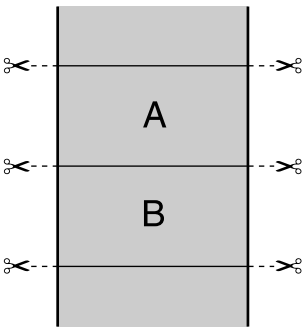
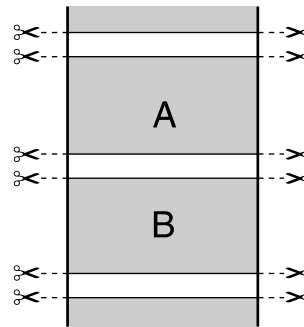
Printer driver settings	Normal Cut	Single Cut	Double Cut
Cutting Operation			
Explanation	<p>The default printer driver setting is Normal Cut.</p>	<ul style="list-style-type: none"> ❑ The top area may become slightly uneven depending on the image since the print operation stops while cutting the top edge of the roll paper. ❑ If the cut position is misaligned slightly, small parts of the image may be shown on the top or bottom of the adjacent pages. If this occurs, perform Adjust Cut Position. 🔗 "Maintenance" on page 123 ❑ When continuously printing multiple sheets, the printer cuts 1 mm inside on the top edge of the first page and the bottom edge of the subsequent pages to avoid showing margins. 	<ul style="list-style-type: none"> ❑ The top area may become slightly uneven depending on the image since the print operation stops while cutting the top edge of the roll paper. ❑ The printed paper is approximately 2 mm shorter than the specified size since the printer cuts the paper inside the image to avoid showing top and bottom margins. ❑ After cutting the bottom edge of the previous page, the printer feeds the paper, and then cuts the top edge of the following page. Although this produces 60 to 127 mm cut-off pieces, the cut is more accurate.

Printing Varieties

Setting Procedures for Printing

Making Settings in Windows

1 When the printer driver's **Main** screen is displayed, you can configure various settings required for printing such as **Media Type**, **Source**, **Page Size**.

"Printing (Windows)" on page 53

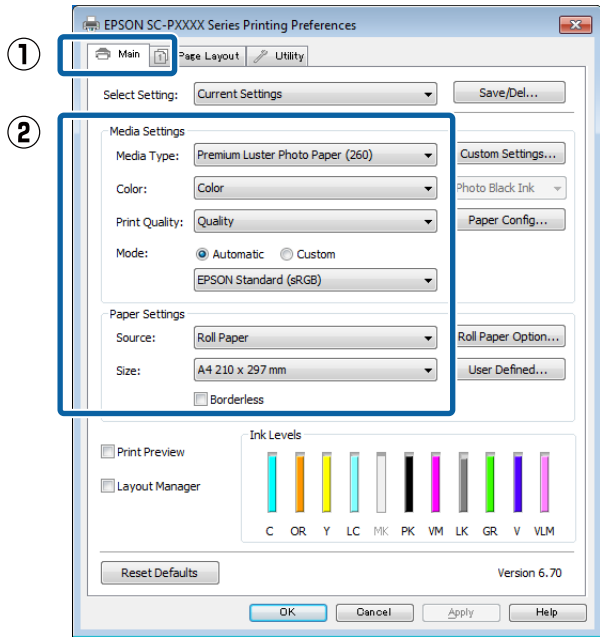

2 Select **Borderless**, and then click **Expansion**. You can not choose the expansion amount when **Roll Paper** or **Roll Paper (Banner)** is selected for **Source**.

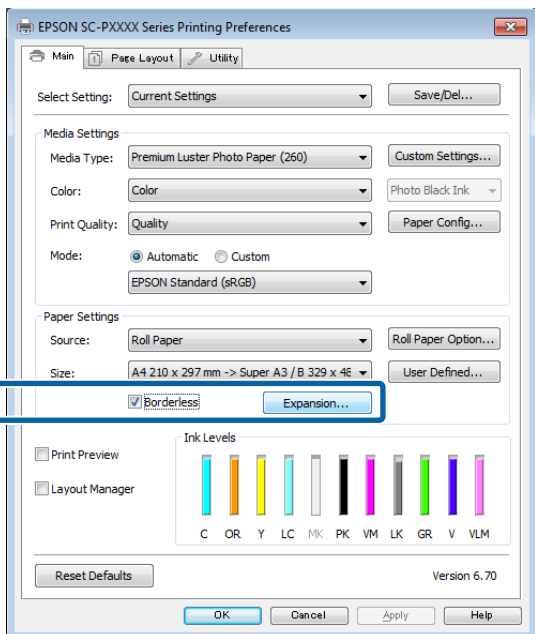

3 Select **Auto Expand** or **Retain Size** as the **Method of Enlargement**.

If you select **Auto Expand**, set how much of the image goes beyond the edge of the paper as shown below.

Max : 3 mm for left and 5 mm for right (the image shifts 1 mm to the right)

Standard : 3 mm for left and right

Mid : 1.5 mm for left and right

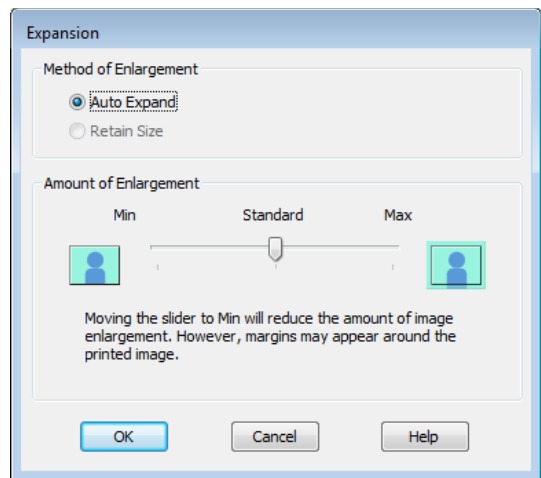

Note:
Moving the slider towards **Mid** decreases the image enlargement ratio. Therefore, some margins may appear at the edges of the paper depending on the paper and printing environment.

Printing Varieties

- 4** When using roll paper, click **Roll Paper Option**, and then set **Auto Cut** option.

[“About Roll Paper Cutting” on page 82](#)

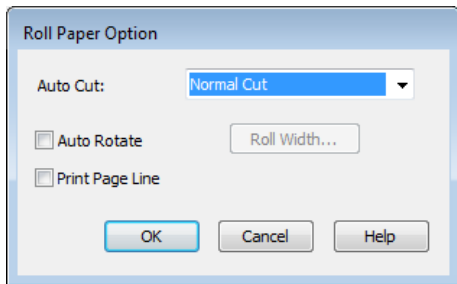
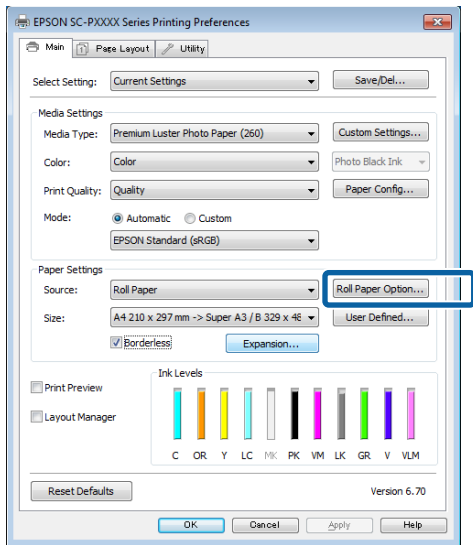

- 5** Check other settings, and then start printing.

Settings in Mac

- 1** Open the Print screen and select the paper size from the **Paper Size** option, and then select a borderless printing method.

[“Performing Printing \(Mac\)” on page 54](#)

The selections for borderless printing methods are displayed as shown below.

- xxxx (Roll Paper - Borderless, Auto Expand)
- xxxx (Roll Paper - Borderless, Retain Size)
- xxxx (Sheet - Borderless, Auto Expand)
- xxxx (Sheet - Borderless, Retain Size)

Where XXXX is the actual paper size, such as A4.

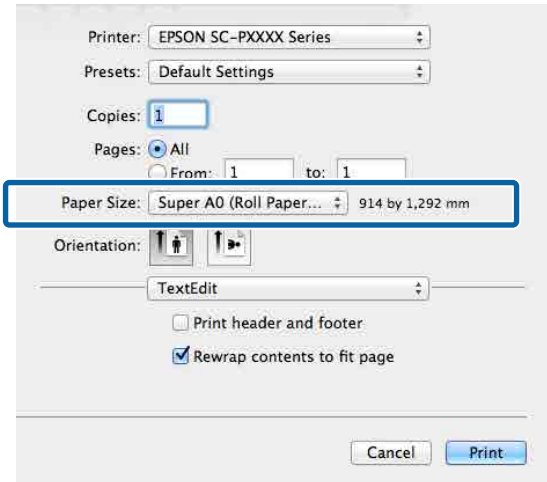

Note:

If page setting options are not available in the application's print dialog, display the page settings dialog.

- 2** Select **Page Layout Settings** from the list, and then set **Roll Paper Option** or **Expansion**.

See the following for more details on **Auto Cut** from **Roll Paper Option**.

[“About Roll Paper Cutting” on page 82](#)

Expansion is only available when **Auto Expand** is selected from **Paper Size**. The following shows the values for each item.

- Max : 3 mm for left and 5 mm for right
(the image shifts 1 mm to the right)
- Standard : 3 mm for left and right
- Mid : 1.5 mm for left and right

Printing Varieties

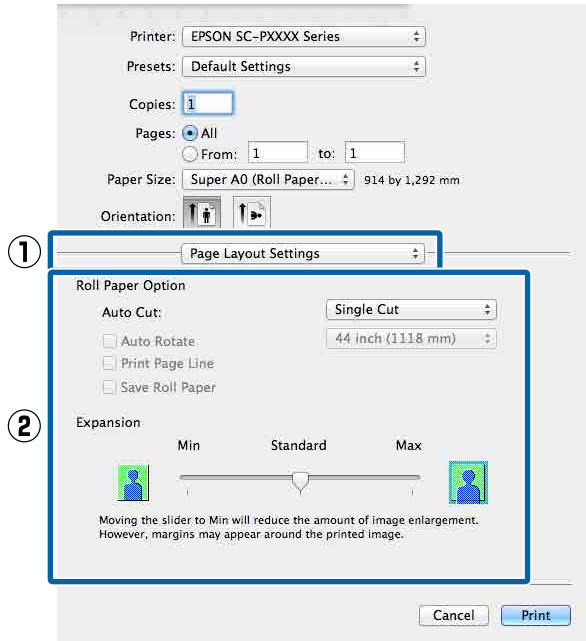

Note:

Moving the slider towards *Mid* decreases the image enlargement ratio. Therefore, some margins may appear at the edges of the paper depending on the paper and printing environment.

3 Check other settings, and then start printing.

Enlarged/Reduced Printing

You can enlarge or reduce the size of your data. There are three setting methods.

- Fit to Output Size printing**
Automatically enlarges or reduces the image size to fit the paper size.

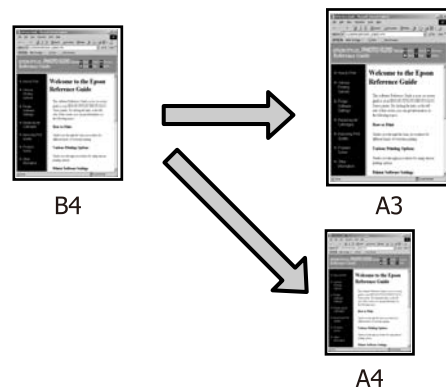

- Fit to Roll Paper Width (Windows only)**
Automatically enlarges or reduces the image size to fit the roll paper width.



- Specify Size**
You can specify the enlargement or reduction ratio. Use this method for a non-standard paper size.

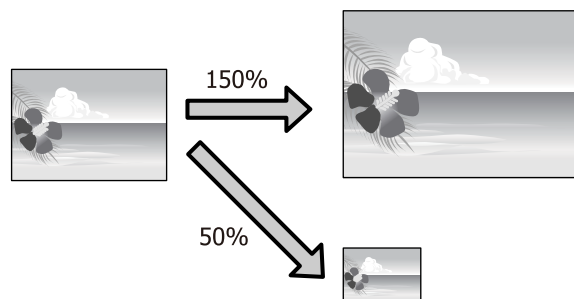

Printing Varieties

Fit to Page/Scale to fit paper size

Making Settings in Windows

1 When the printer driver's **Layout** screen is displayed, set the same paper size as the data's paper size in **Page Size** or **Paper Size**.

"Printing (Windows)" on page 53

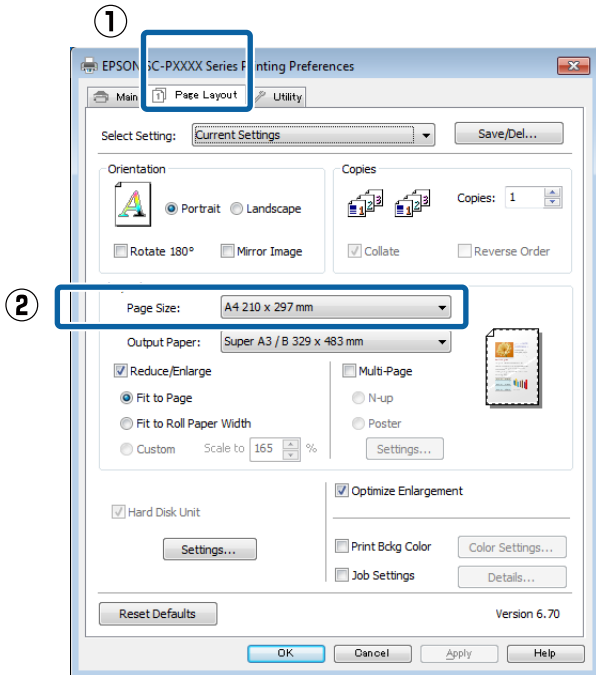

2 Select the size of the paper loaded in the printer from the **Output Paper** list.

Fit to Output Size is selected as **Reduce/Enlarge**.

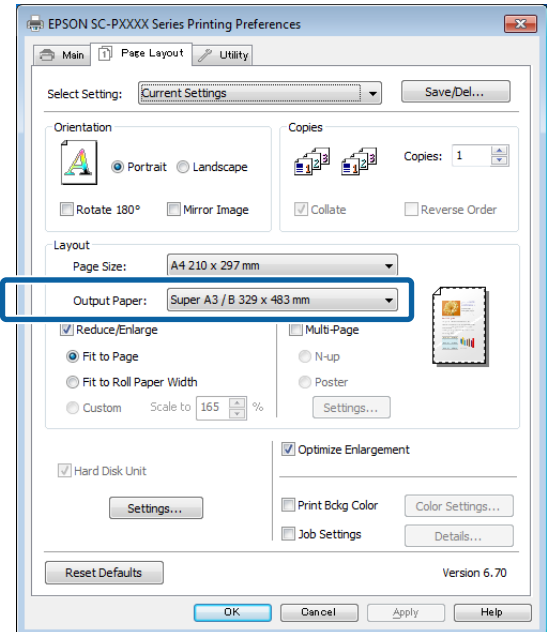

3 Check other settings, and then start printing.

Settings in Mac

1 Open the Print screen, select **Paper Handling** from the list, and then check **Scale to fit paper size**.

"Performing Printing (Mac)" on page 54

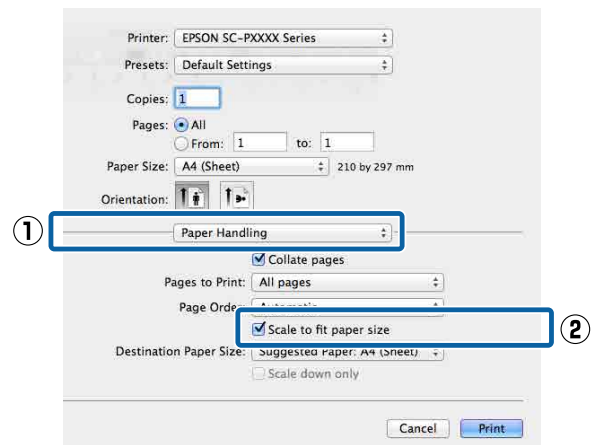

Printing Varieties

- 2 Select the size of the paper loaded in the printer as the **Destination Paper Size**.

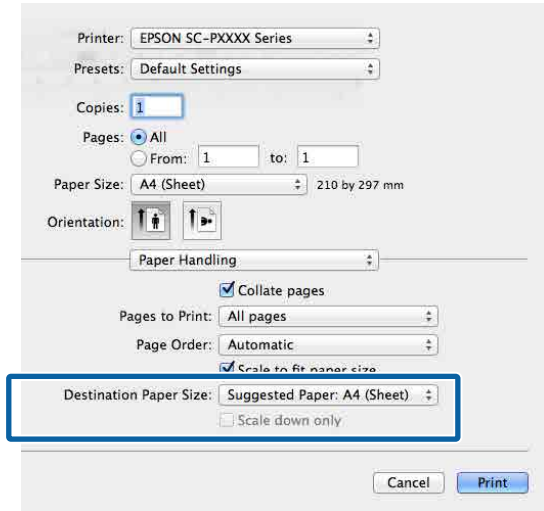

Note:
When performing enlarged printing, clear the **Scale down only** check box.

- 3 Check other settings, and then start printing.

Fit to Roll Paper Width (Windows Only)

- 1 Display the printer driver **Main** tab and select **Roll Paper** for **Source**.
[“Printing \(Windows\)” on page 53](#)
- 2 Display the **Layout** tab and choose a **Page Size** that matches the page size used in the document size.

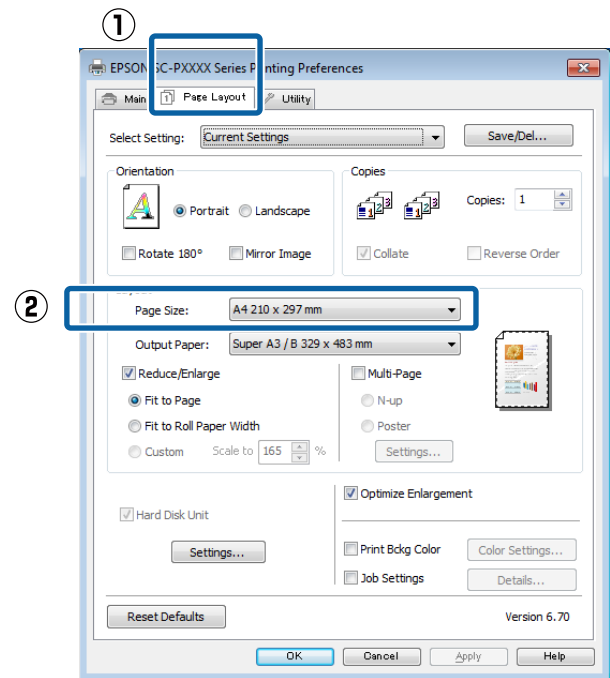

- 3 Select the size of the paper loaded in the printer from the **Output Paper** list.
Fit to Output Size is selected as **Reduce/Enlarge**.

Printing Varieties

4 Select Fit to Roll Paper Width.

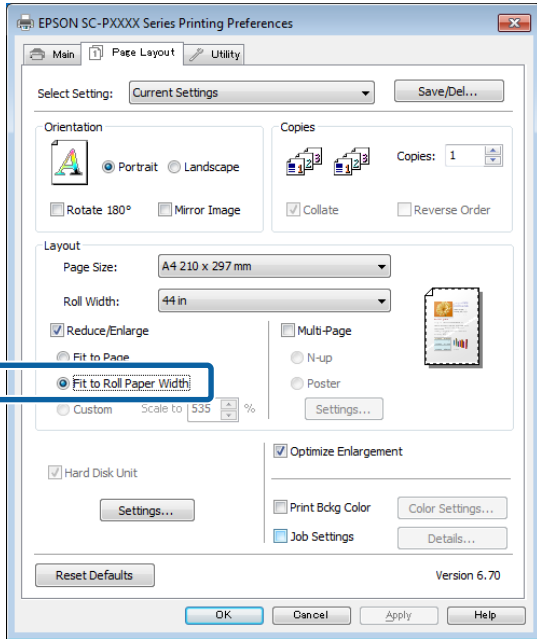

5 Select the width of the roll paper loaded in the printer from the Roll Width list.

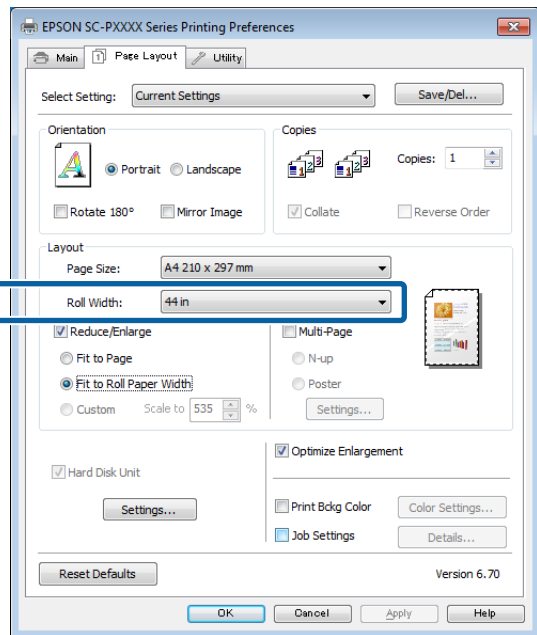

6 Check other settings, and then start printing.

Custom Scale Setting

Making Settings in Windows

1 When the printer driver's **Layout** screen is displayed, set the same paper size as the data's paper size in **Page Size** or **Paper Size**.

[“Printing \(Windows\)” on page 53](#)

2 Select the size of the paper loaded in the printer from the **Output Paper** list.

Fit to Output Size is selected as **Reduce/Enlarge**.

3 Select **Specify Size**, and then set the **Scale** to value.

Enter a value directly or click the arrows to the right of the scale box to set the value.

Select the scale within a range of 10 to 650 %.

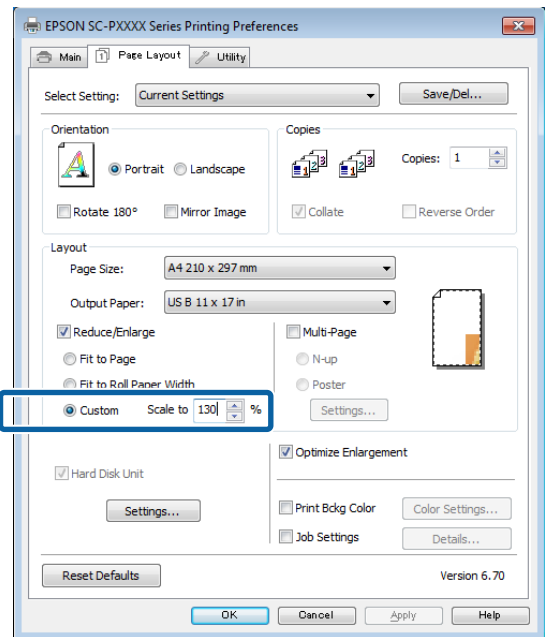

4 Check other settings, and then start printing.

Printing Varieties

Settings in Mac

- 1 When the Print screen is displayed, select the size of the paper loaded in the printer from the **Paper Size** list.

[“Performing Printing \(Mac\)” on page 54](#)

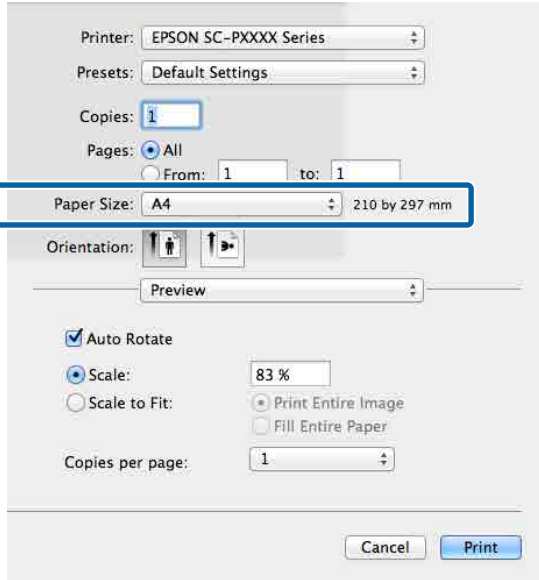

- 2 Click **Scale**, and then enter the scale.

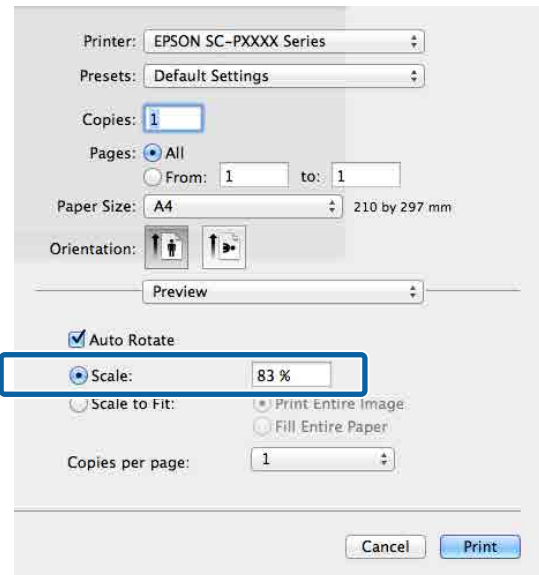

If the Print screen in the application you are using does not have an input item for the scale that you want to use, display the Layout screen and make settings.

[“Performing Printing \(Mac\)” on page 54](#)

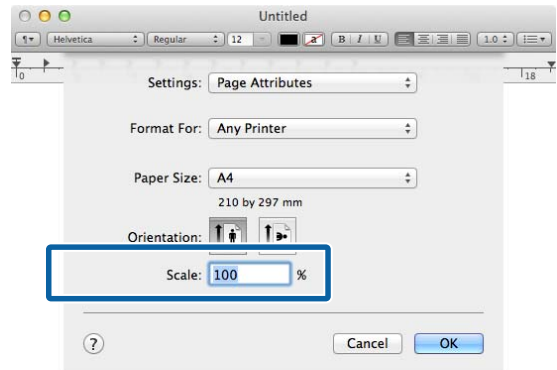

Printing Varieties

Multi-Page Printing

You can print multiple pages of your document on one sheet of paper.

If you print continuous data prepared at A4 size, it is printed as shown below.

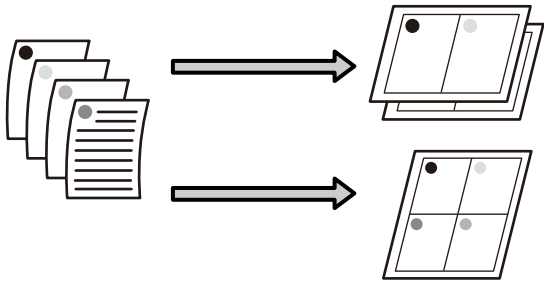

Note:

- In Windows, you cannot use the Multi-Page printing function when performing borderless printing.
- In Windows, you can use the reduce/enlarge function (Fit to Page) to print the data on different sizes of paper.

[“Enlarged/Reduced Printing” on page 85](#)

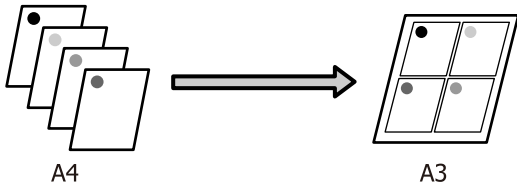

Making Settings in Windows

- 1** When the printer driver’s **Layout** screen is displayed, select **Multi-Page**, and then click **N-up - Settings**.

[“Printing \(Windows\)” on page 53](#)

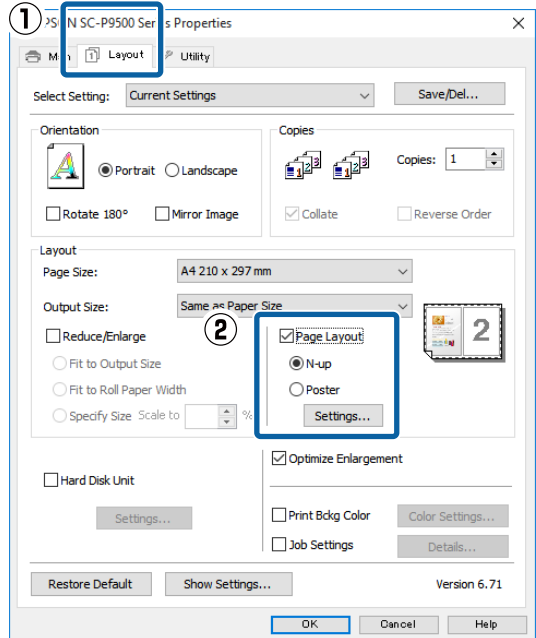

- 2** In the **Print Layout** screen, specify the number of pages per sheet and the page order.

If the **Print page frames** check box is selected, page frames are printed on each page.

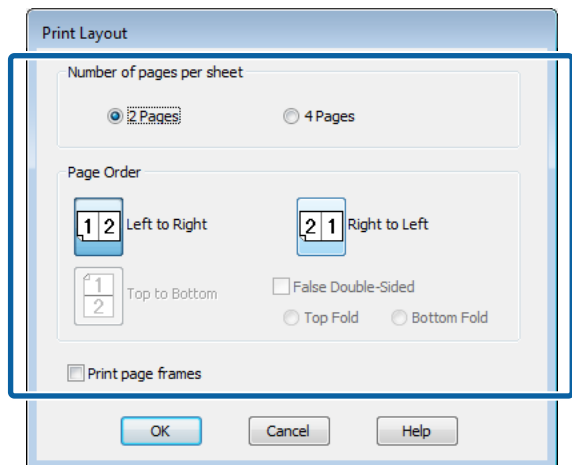

- 3** Check other settings, and then start printing.

Printing Varieties

Settings in Mac

- 1 When the Print screen is displayed, select **Layout** from the list, and then specify the number of pages per sheet and so on.

“Performing Printing (Mac)” on page 54

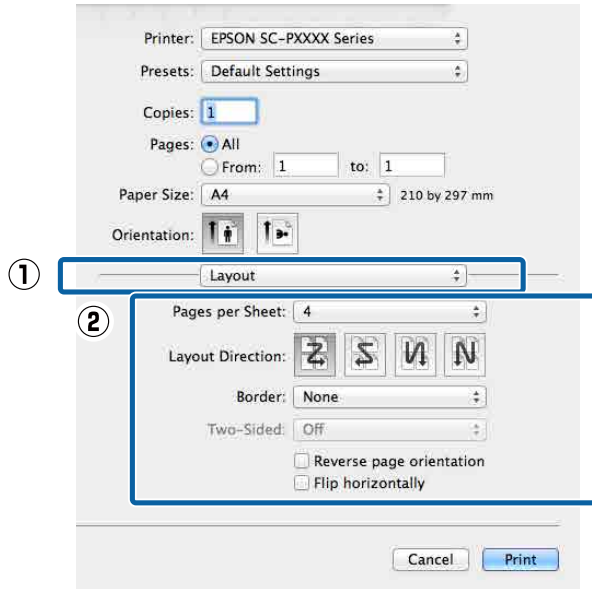

Note:
You can print frames around arranged pages using the **Border** function.

- 2 Check other settings, and then start printing.

Poster Printing (Enlarge to cover several sheets and print - Windows only)

The poster printing function automatically enlarges and divides the print data. You can join the printed sheets to create a large poster or calendar. Poster printing is available up to 16-fold (four sheets by four sheets) of normal printing size. There are two ways to print posters.

- Borderless poster printing**
This automatically enlarges and divides the print data and prints without margins. You can make a poster just by joining the output paper together. To perform borderless printing, the data is expanded so that it extends slightly over the paper size. Enlarged areas that exceed the paper are not printed. Therefore, the image may misalign at the joins. To join the pages precisely, perform the following poster printing with margins.



- Poster printing with margins**
This automatically enlarges and divides the print data and prints with margins. You need to cut the margins and then join the output paper together to make a poster. Although the final size is slightly smaller since you have to cut off the margins, the image joins fit precisely.

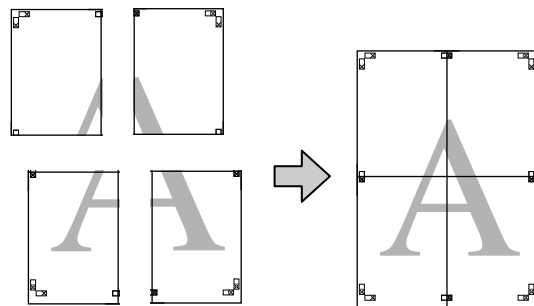

Printing Varieties

Setting Procedures for Printing

- 1 Prepare the print data using applications.
The printer driver automatically enlarges the image data when printing.
- 2 When the printer driver's **Layout** screen is displayed, select **Multi-Page**, and then click **Poster Settings - Settings**.

☞ "Printing (Windows)" on page 53

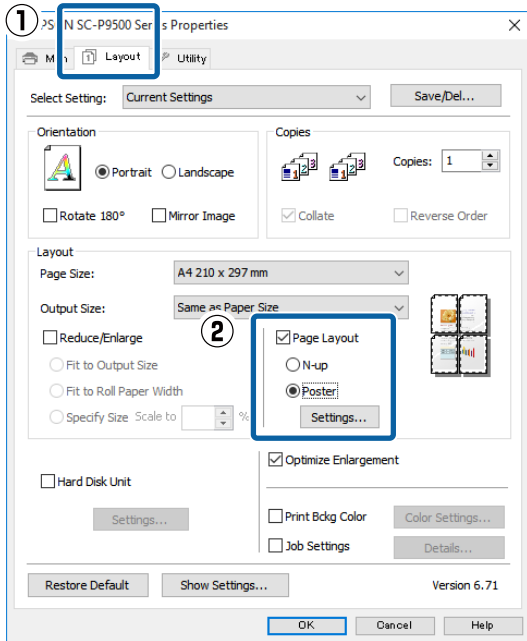

- 3 Set the number of panels on the **Poster Settings** screen.

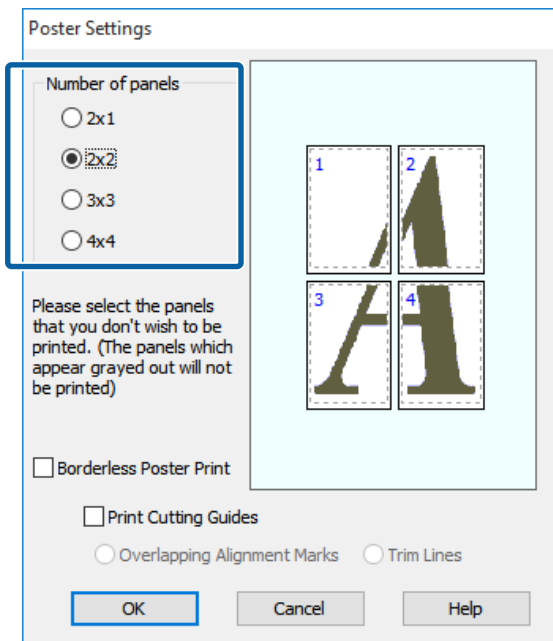

- 4 Select borderless poster printing or poster printing with margins, and then select any pages that you do not want to print.

When borderless is selected:

Select **Borderless Poster Print**.

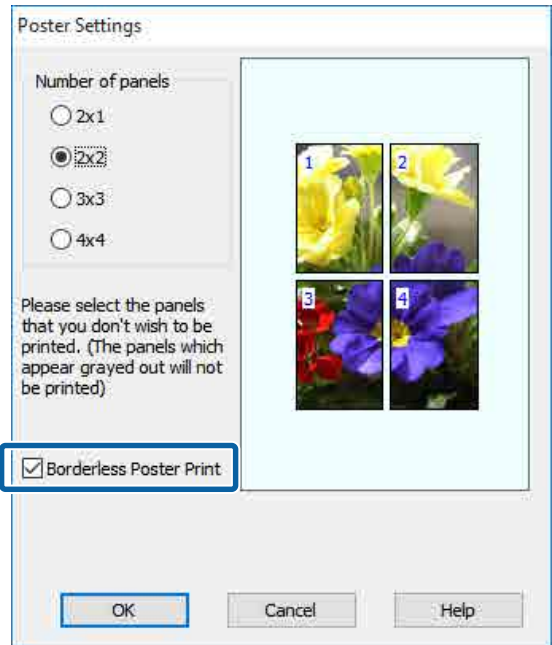

Note:

If **Borderless Poster Print** is grayed out, the selected paper or the size does not support borderless printing.

☞ "Epson Special Media Table" on page 168

☞ "Supported Commercially Available Paper" on page 179

Printing Varieties

When with margins is selected:

Clear **Borderless Poster Print**.

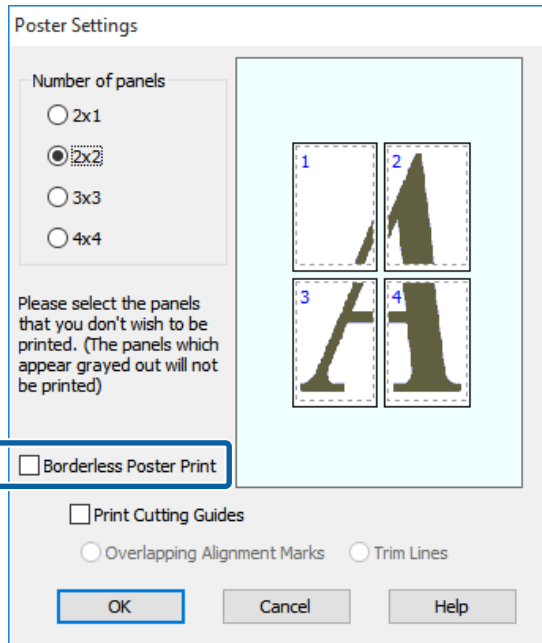

Note:
 Regarding the size after joining together:
 When **Borderless Poster Print** is cleared and printing with margins is selected, the **Print Cutting Guides** items are displayed.
 The finished size is the same whether or not **Print page frames** is selected. However, if **Overlapping Alignment Marks** is selected, the finished size is smaller with an overlap.

- 5 Check other settings, and then start printing.

Joining the output paper together

The steps for joining the output paper together differ between borderless poster printing and poster printing with margins.

For borderless poster printing

This section describes how to join four printed pages together. Check and match the printed pages, and join them in the order indicated below using an adhesive tape on the back of the sheets.

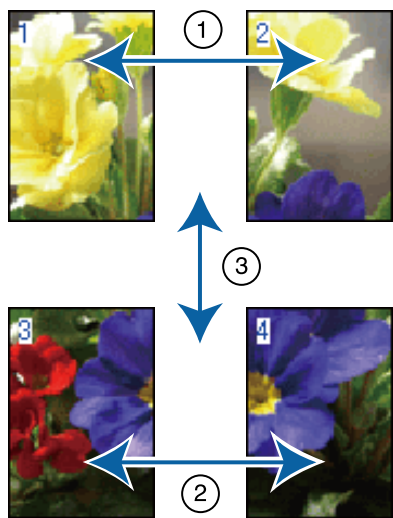

For poster printing with margins

If **Overlapping Alignment Marks** is selected, join guides (indicated by the lines drawn through and around the X marks in the illustration below) will be printed on each sheet.

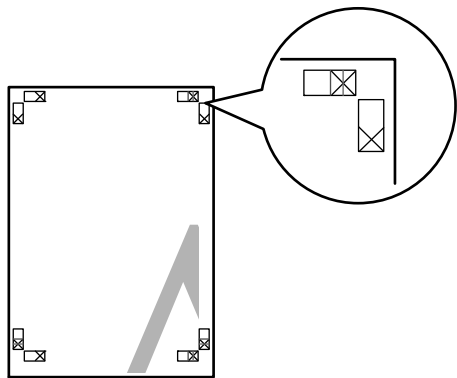

Note:
 The alignment marks are black for black-and-white printing.

Printing Varieties

The following section describes how to join four printed pages together.

- 1 Ready the two top sheets and trim the excess from the left sheet by cutting along the line joining the two join guides (the centers of the X marks).

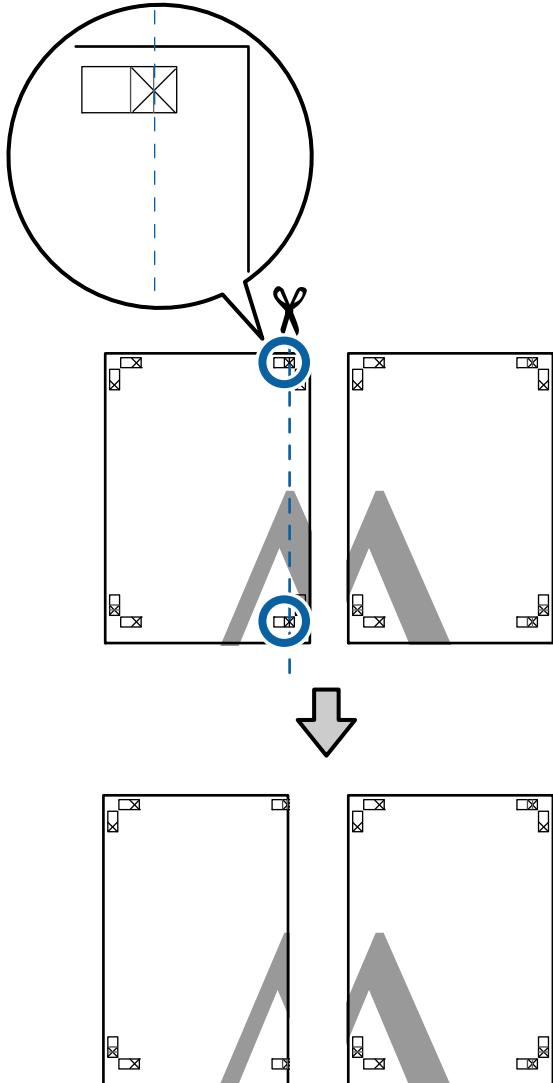

- 2 Lay the upper left sheet on top of upper right sheet. Lineup the X marks as shown in the illustration below, and temporarily fasten them using an adhesive tape on the back.

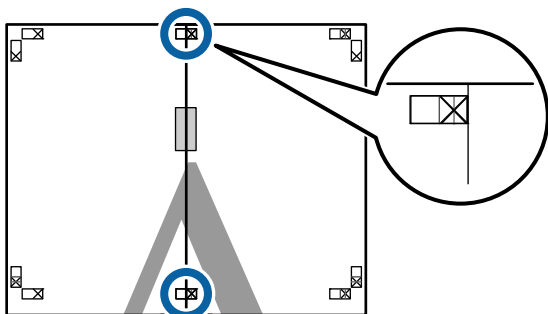

- 3 With the two sheets overlapping, trim the excess by cutting along the line joining the two cut guides (the lines to the left of the X marks).

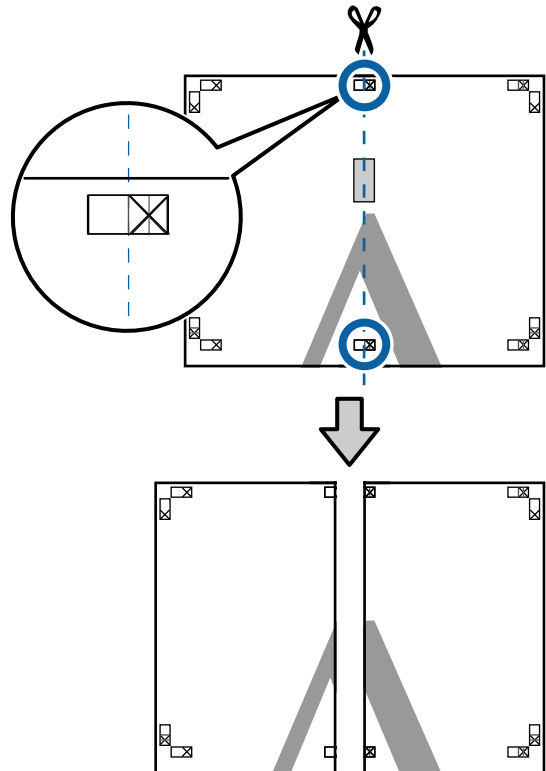

- 4 Rejoin the two sheets. Use an adhesive tape to stick the backs of the sheets together.

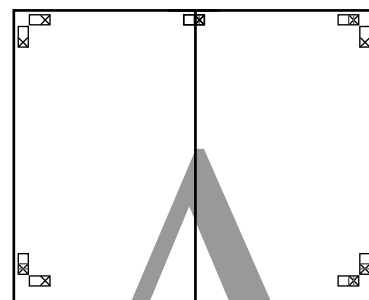

- 5 Repeat Steps 1 to 4 for the lower sheets.

Printing Varieties

- 6** Trim the bottom from the upper sheets by cutting along the line joining the two guides (the lines above the X marks).

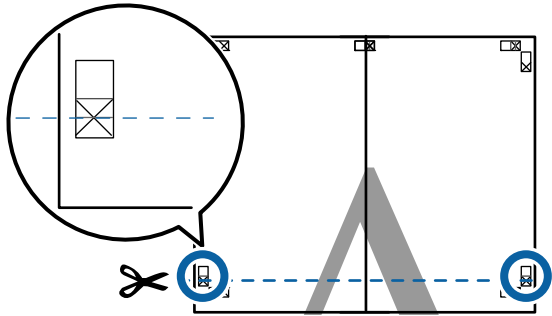

- 7** Lay the upper sheet on top of the lower sheet. Lineup the X marks as shown in the illustration below, and temporarily fasten them using an adhesive tape on the back.

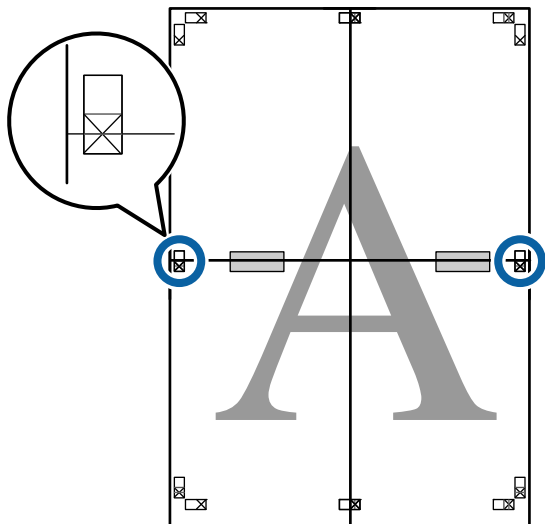

- 8** With the two sheets overlapping, trim the excess by cutting along the line joining the two guides (the lines above the X marks).

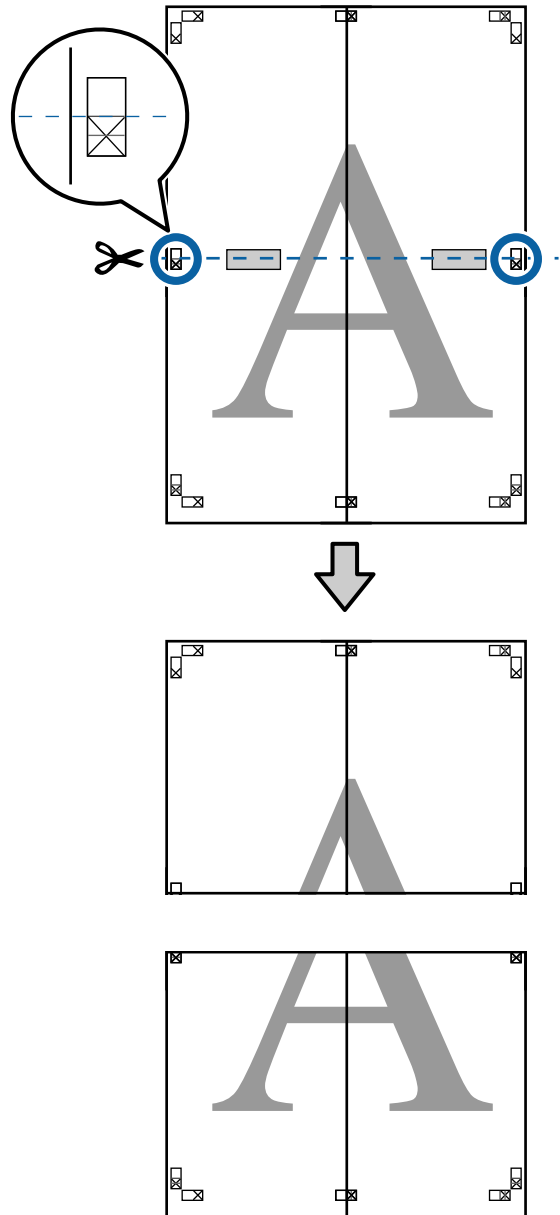

Printing Varieties

- 9** Join the upper and lower sheets together.
Use an adhesive tape to stick the backs of the sheets together.

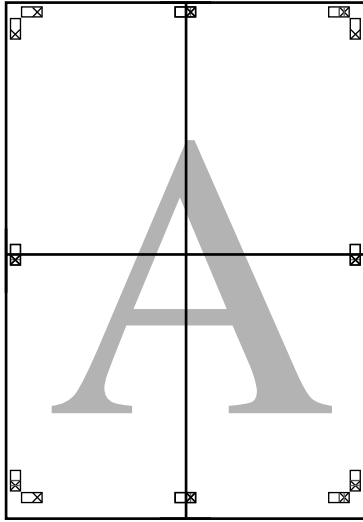

- 10** After joining all the sheets, trim off the borders by cutting along the cut guides (outside the X marks).

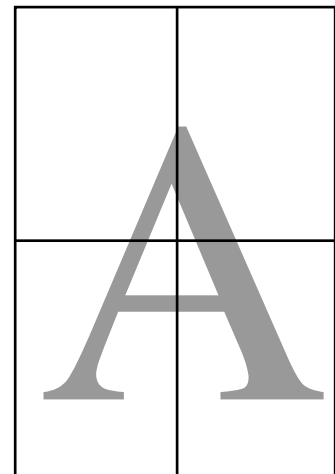
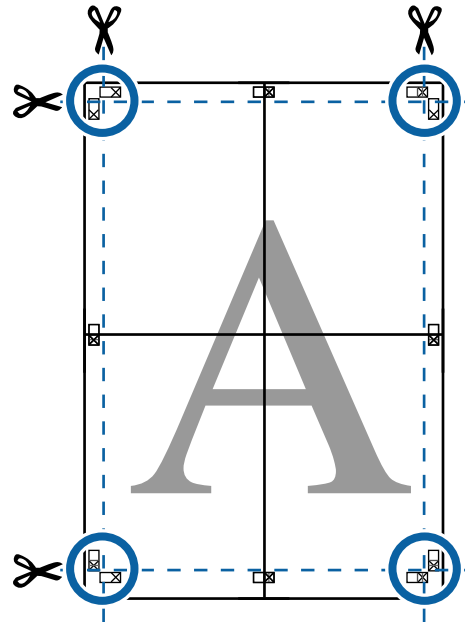

Printing Varieties

Printing at Non-Standard Sizes

Before printing at non-standard sizes, including vertical or horizontal banners and documents with equal sides, save the desired paper size in the printer driver. Once they have been saved in the printer driver, custom sizes can be selected in the application **Page Layout** and other print dialogs.

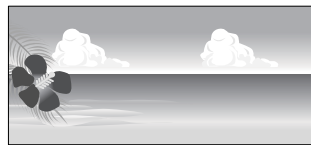

Supported paper sizes

The following table shows the paper sizes that can be set in the printer driver. See the following for paper sizes supported by the printer.

“Printable area” on page 58

Paper Width	SC-P9500 Series	89*1 to 1118 mm
	SC-P7500 Series	89*1 to 610 mm
Paper Height	Windows: 127*1 to 18,000 mm Mac: 127*1 to 18,000 mm*2	

- *1 The smallest size supported by the printer is 182 mm wide by 254 mm long. If a smaller size is entered in the printer driver as a Custom Paper Size, the document will print with wider-than-expected margins, which must be trimmed.
- *2 For Mac OS X **Custom Paper Sizes**, although you can specify a large paper size which cannot be loaded on this printer, it will not be printed properly.

Important:

When using commercially available software, the possible output sizes are restricted. If you are using applications that support banner printing, you can set a longer paper length. See the application's manual for details.

Making Settings in Windows

1 When the printer driver's **Main** screen is displayed, click **User Defined**.

“Printing (Windows)” on page 53

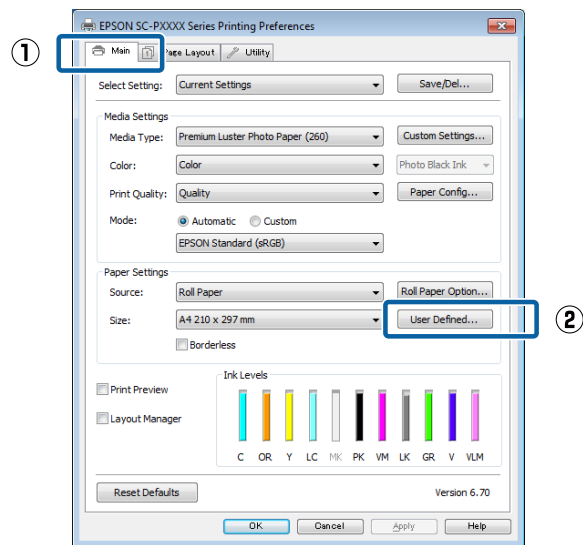

2 In the **User-Defined Paper Size** screen, set the paper size you want to use, and then click **Save**.

- ❑ You can enter up to 24 single-byte characters for the **Paper Size Name**.
- ❑ The length and width values for a pre-defined size close to the desired custom size can be displayed by selecting the appropriate option in the **Base Paper Size** menu.

Printing Varieties

- If the length and width ratio is the same as a defined paper size, select the defined paper size from **Fix Aspect Ratio** and select either **Landscape** or **Portrait** for the **Base**. In this case, you can only adjust either the paper width or paper height.

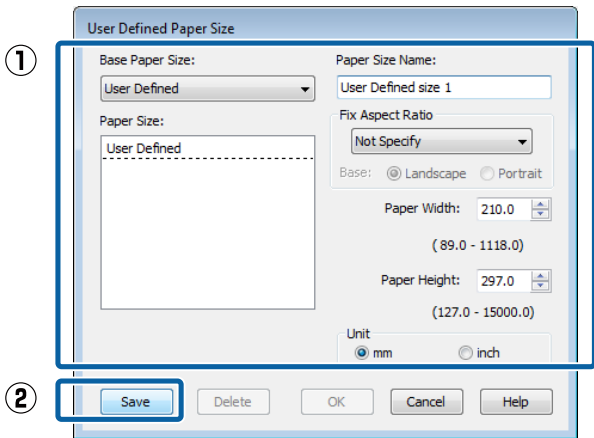

Note:

- To change the paper size you saved, select the paper size name from the list on the left.
- To delete the user-defined size you saved, select the paper size name from the list on the left, and then click **Delete**.
- You can save up to 100 paper sizes.

3 Click **OK**.

You can now select the new paper size from the **Paper Size** menu in the **Main** tab.

You can now print as normal.

Settings in Mac

1 When the Print screen is displayed, select **Manage Custom Sizes** from the **Paper Size** list.

If page setting options are not available in the application's print dialog, display the page settings dialog.

[“Performing Printing \(Mac\)” on page 54](#)

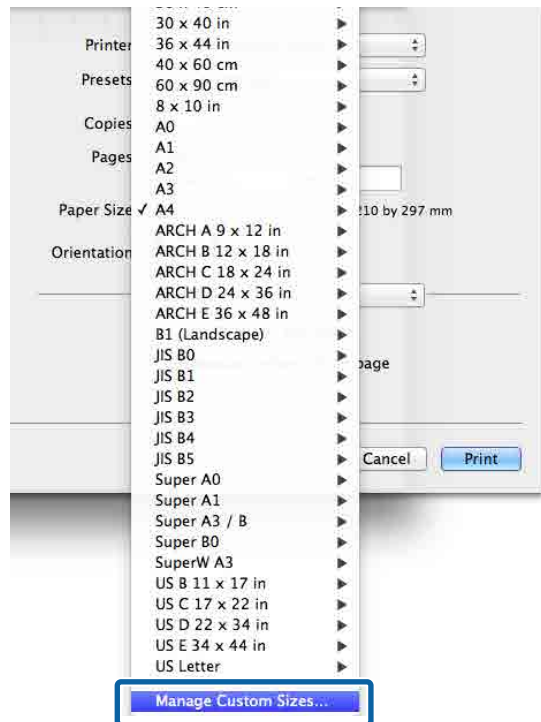

2 Click **+**, and then enter the paper size name.

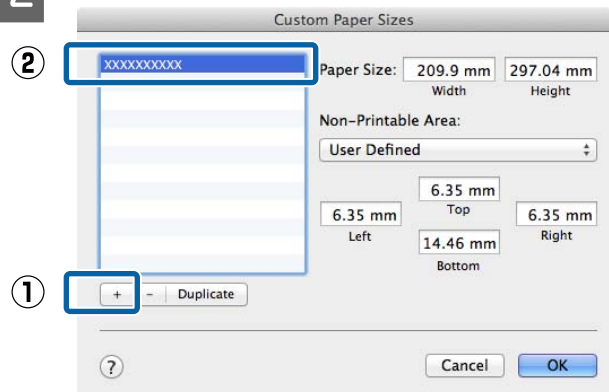

3 Enter the **Width**, **Height** for the **Paper Size**, enter the margins, and then click **OK**.

You can set the page size and printer margins depending on the printing method.

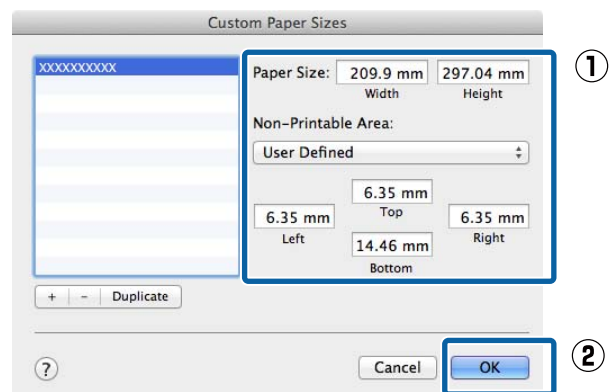

Printing Varieties

Note:

- ❑ To edit a saved custom size, choose its name from the list on the left.
- ❑ To copy a saved custom size, select the size in the list on the left and click **Duplicate**.
- ❑ To delete a saved custom size, select it in the list on the left and click **-**.
- ❑ The custom paper size setting differs depending on the operating system version. See your operating system's documentation for details.

4 Click **OK**.

You can select the paper size you saved from the Paper Size pop-up menu.

You can now print as normal.

Banner printing (on roll paper)

You can print banners and panoramic pictures if you create and set print data for banner printing in your application.

There are two ways to print a banner.

Printer Driver Source	Supported Applications
Roll Paper	Document preparation software, image editing software, and so on*
Roll paper (Banner)	Applications that support banner printing

* Create print data at a size supported by the given application while maintaining the printing length and width ratio.

See the following for available paper sizes.

[“Printing at Non-Standard Sizes” on page 97](#)

Making Settings in Windows

1 In the printer driver's **Main** screen, select **Media Type**.

[“Printing \(Windows\)” on page 53](#)

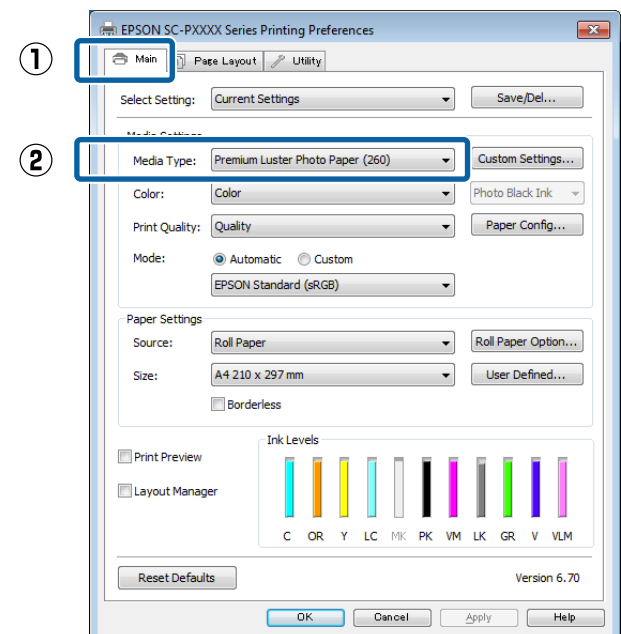

Printing Varieties

- 2** Select **Roll Paper** or **Roll Paper (Banner)** from the **Source** list.

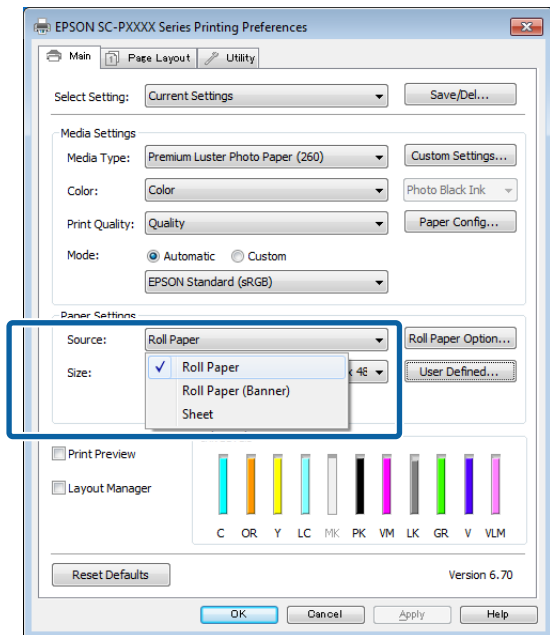

Note:

- You can only use **Roll Paper (Banner)** for applications that support banner printing.
- Selecting **Roll Paper (Banner)** sets the top and bottom margins of the paper to 0 mm.

- 3** Click **User Defined** and match the paper size to the size of the data if necessary.

Note:

If you are using applications that support banner printing, you do not need to set **User-Defined Paper Size** if you select **Roll Paper (Banner)** as the **Source**.

- 4** On the **Layout** screen make sure the **Monitoring Preferences** check box is selected.

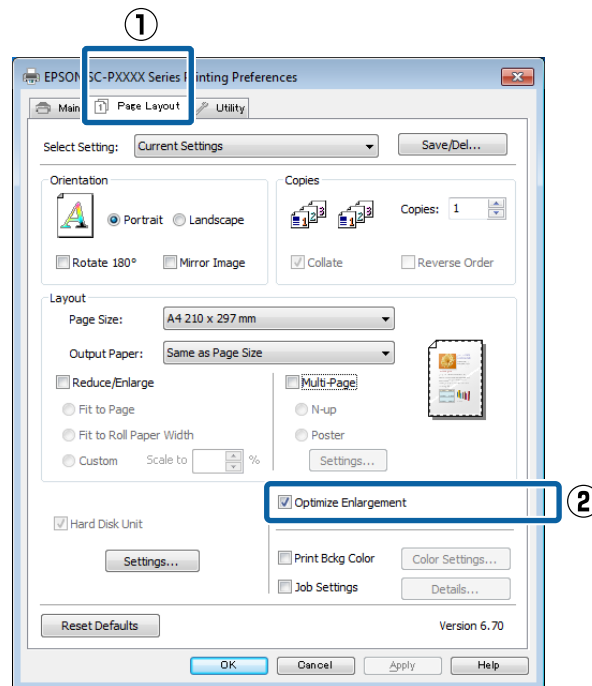

- 5** Check other settings, and then start printing.

Settings in Mac

- 1** When the **Print** screen is displayed, select the size of the data created with the application in **Paper Size**.

If page setting options are not available in the application's print dialog, display the page settings dialog.

[“Performing Printing \(Mac\)” on page 54](#)

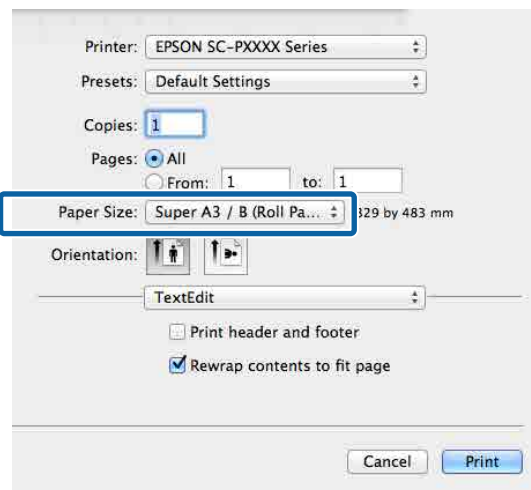

- 2** Check other settings, and then start printing.

Printing Varieties

Layout Manager (Windows Only)

The Layout Manager function allows you to place multiple pieces of print data created in different applications on the paper freely and print them at once.

You can create a poster or display material by placing multiple pieces of print data where you like. Also, Layout Manager allows you to use paper effectively.

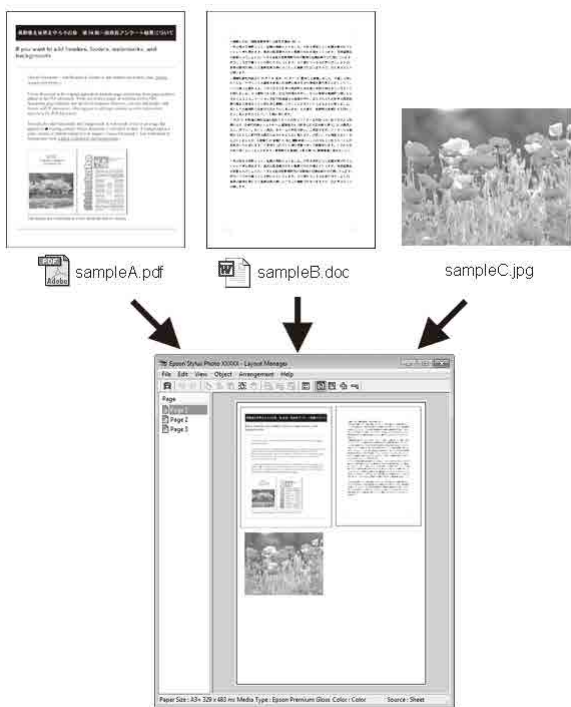

The following is a layout example.

Placing multiple data items

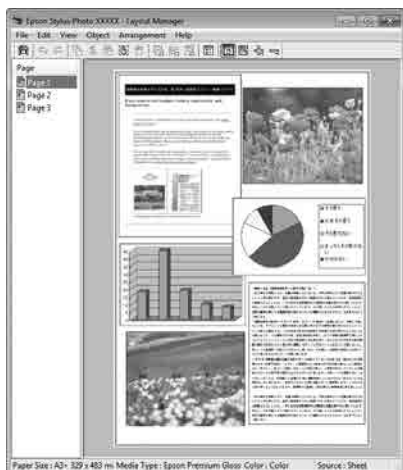

Placing the same data

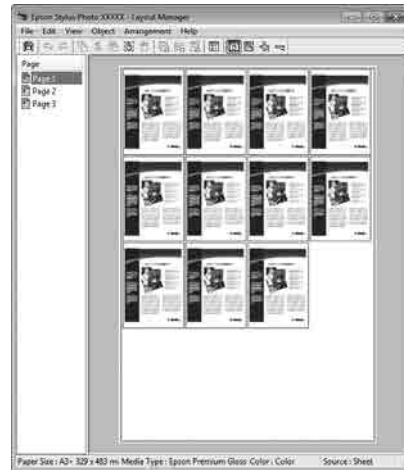

Placing data freely

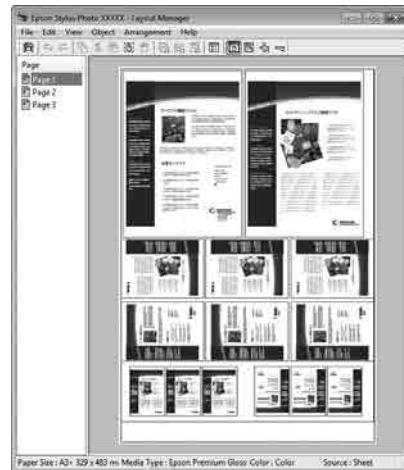

Placing data on roll paper

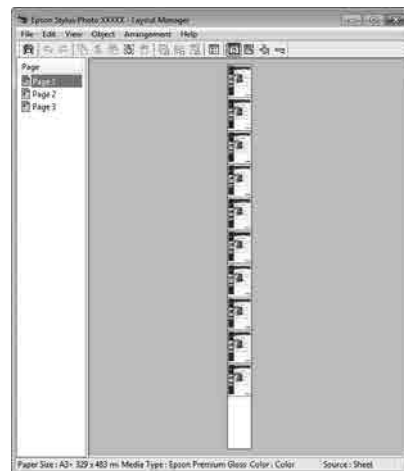

Setting Procedures for Printing

- 1 Check that the printer is connected and ready to print.

Printing Varieties

- 2 Open the file you want to print in your application.
- 3 Select **Layout Manager** in the **Main** tab of the printer driver and choose an option for **Paper Size** that matches the size of the document created in the application.

"Printing (Windows)" on page 53

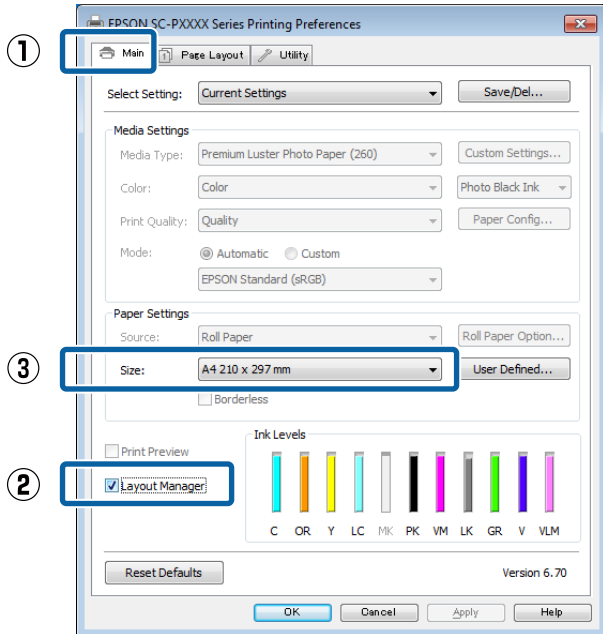

Note:

The option selected for **Paper Size** is the size used in the **Layout Manager**. The actual printing paper size is set in the screen in Step 7.

- 4 Click **OK**. When printing with an application, the **Layout Manager** screen opens.
The print data is not printed, but one page is placed on the paper of the **Layout Manager** screen as one object.
- 5 Leave the **Layout Manager** screen open and repeat steps 2 to 4 to arrange the next pieces of data.
The objects are added to the **Layout Manager** screen.
- 6 Arrange the objects on the **Layout Manager** screen.
Objects can be dragged to new positions and resized; in addition, they can be rearranged or rotated using the options in the Object menu.

The overall size and placement of the objects can be changed using the **Preferences** and **Arrangement** options in the File menu.

See the **Layout Manager** screen help for more details on each function.

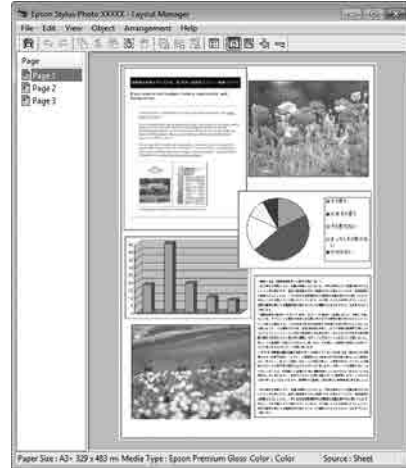

Printing Varieties

- Click **File - Properties**, and make print settings on the printer driver screen.

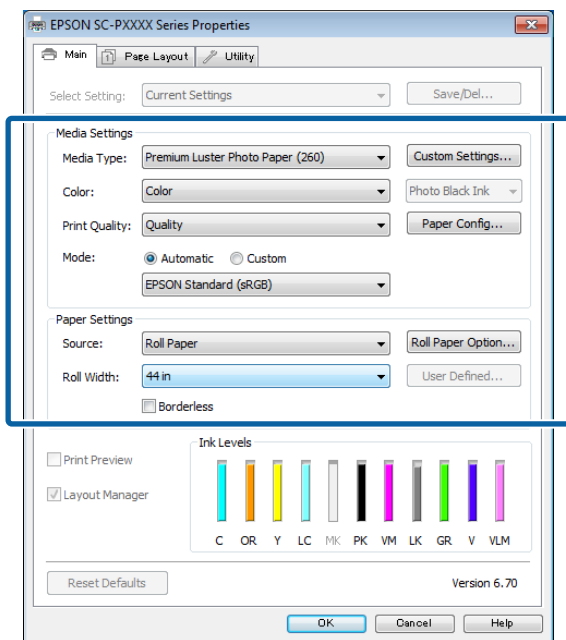
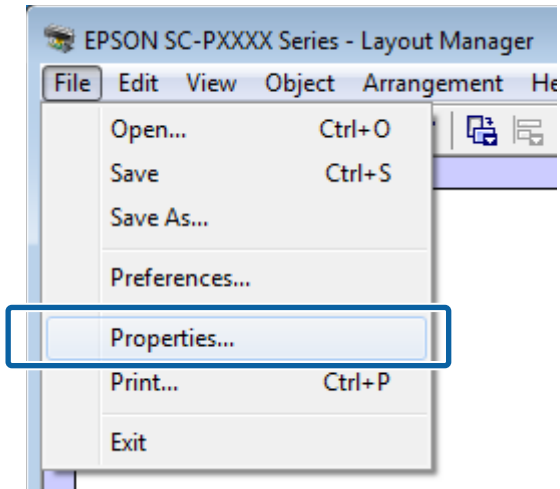

Set **Media Type, Source, Paper Size or Page Size**, and so on.

- Click the **File** menu on the **Layout Manager** screen, and then click **Print**.

Printing starts.

Saving and Recalling Settings

You can save the **Layout Manager** screen arrangement and setting contents to a file. If you need to close your application in the middle of a job, you can save it to a file and then open it later to continue your work.

Saving

- On the **Layout Manager** screen, click **File** menu and then **Save as**.
- Enter the file name, select the location, and then click **Save**.
- Close the **Layout Manager** screen.

Opening saved files

- Right-click the utility icon () in the Windows taskbar and select **Layout Manager** from the menu that appears.

The **Layout Manager** screen is displayed.

If the Utility shortcut icon is not displayed on the Windows Taskbar

 [“Summary of the Utility Tab” on page 69](#)

- On the **Layout Manager** screen, click **File** menu and then **Open**.
- Select the location and open the required file.

Color Management Printing

About Color Management

Even when using the same image data, the original image and the displayed image may look different, and the printed results may look different to the image you see on the display. This occurs due to the difference in characteristics when input devices such as scanners and digital cameras capture colors as electronic data, and when output devices such as display screens and printers reproduce colors from the color data. The color management system is a means to adjust differences in color conversion characteristics among input and output devices. As well as applications for image processing, each operating system is equipped with a color management system, such as ICM for Windows and ColorSync for Mac OS X.

In a color management system, a color definition file called a "Profile" is used to perform color matching between devices. (This file is also called an ICC profile.) The profile of an input device is called an input profile (or source profile), and the profile of an output device, such as a printer, is called a printer profile (or output profile). A profile is prepared for each media type in this printer's driver.

The color conversion areas by the input device and the color reproduction area by the output device differ. As a result, there are color areas that do not match even when performing color matching using a profile. In addition to specifying profiles, the color management system also specifies conversion conditions for areas where color matching failed as "intent". The name and type of intent vary depending on the color management system you are using.

You cannot match the colors on the printed results and display by color management between the input device and the printer. To match both colors, you need to perform color management between the input device and the display as well.

Color Management Print Settings

You can perform color management printing using this printer's printer driver in the following two ways.

Choose the best method according to the application you are using, the operating system environment, the aim of the print out, and so on.



Setting color management with the applications

This method is for printing from applications that support color management. All color management processes are carried out by the application's color management system. This method is useful when you want to obtain the same color management print results using a common application among different operating system environments.

 ["Setting color management with the applications" on page 105](#)

Setting color management with the printer driver

The printer driver uses the operating system's color management system and carries out all color management processes. You can make color management settings in the printer driver using the following two methods.

- ❑ Host ICM (Windows) / ColorSync (Mac OS X)
Set when printing from applications that support color management. This is effective in producing similar print results from different applications under the same operating systems.
 ["Color management printing by Host ICM \(Windows\)" on page 107](#)
 ["Color Management Printing by ColorSync \(Mac\)" on page 108](#)
- ❑ Driver ICM (Windows only)
This allows you to perform color management printing from applications that do not support color management.
 ["Color management printing by Driver ICM\(Windows Only\)" on page 108](#)

Color Management Printing

Setting profiles

Settings for the input profile, printer profile, and intent (matching method) vary between three types of color management printing since their color management engines are used differently. This is because color management usage differs between the engines. Make settings in the printer driver or application as described in the following table.

	Input profile settings	Printer profile settings	Intent settings
Driver ICM (Windows)	Printer Driver	Printer Driver	Printer Driver
Host ICM (Windows)	Application	Printer Driver	Printer Driver
ColorSync (Mac OS X)	Application	Printer Driver	Application
Application	Application	Application	Application

Printer profiles for each paper type that is needed when performing color management are installed with the printer's printer driver. You can select the profile from the printer driver's settings screen.

You can select the profile from the printer driver's settings screen.

[🔗 “Color management printing by Driver ICM\(Windows Only\)” on page 108](#)

[🔗 “Color management printing by Host ICM \(Windows\)” on page 107](#)

[🔗 “Color Management Printing by ColorSync \(Mac\)” on page 108](#)

[🔗 “Setting color management with the applications” on page 105](#)

Setting color management with the applications

Print using applications with a color management function. Make the color management settings in the application and disable the printer driver's color adjustment function.

- 1 Make color management settings in the applications.

Setting example for Adobe Photoshop CS5

Open the **Print** screen.

Select **Color Management** and then **Document**. Select **Photoshop Manages Colors** as the **Color Handling** setting, select the **Printer Profile** and the **Rendering Intent**, and then click **Print**.

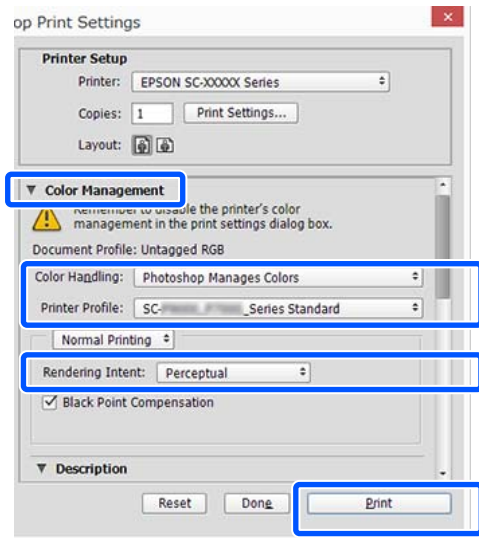

- 2 Display the printer driver's settings screen (Windows) or Print screen (Mac).

Make printer driver settings.

For Windows

[🔗 “Printing \(Windows\)” on page 53](#)

For Mac

[🔗 “Performing Printing \(Mac\)” on page 54](#)

Color Management Printing

3

Set color management to off.

For Windows

In the **Main** screen, select **Specify Size** as the **Mode** setting, and select **Off (No Color Adjustment)**.

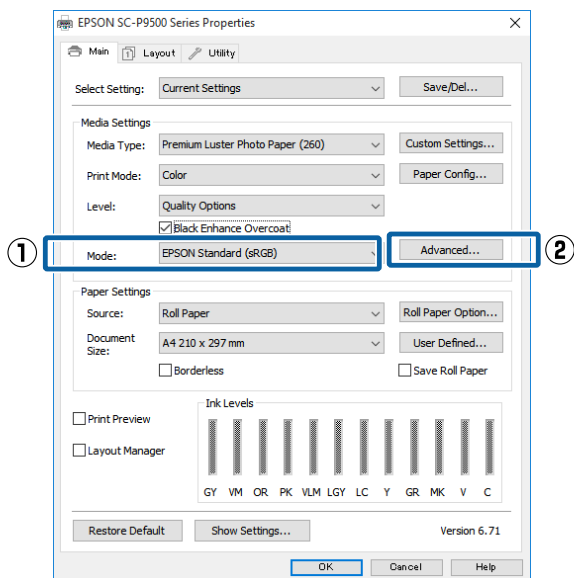

Note:

In Windows 7, Windows Vista, and Windows XP (Service Pack 2 or later and .NET 3.0) Off (No Color Adjustment) is selected automatically.

For Mac

Select **Print Settings** from the list, and then select **Off (No Color Adjustment)** as the **Printer Color Adjustment** setting.

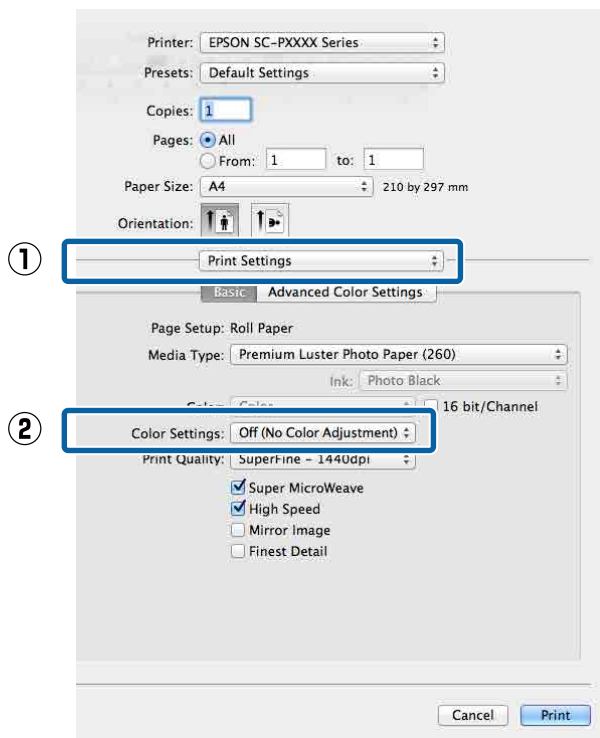

4

Check other settings, and then start printing.

Color Management Printing

Setting color management with the printer driver

Color management printing by Host ICM (Windows)

Use image data in which an input profile has been embedded. Also, the application must support ICM.

1 Make the settings for color adjustment using the application.

Depending on the type of the application, make the settings following the table below.

Adobe Photoshop CS3 or later
 Adobe Photoshop Elements 6.0 or later
 Adobe Photoshop Lightroom 1 or later

OS	Color Management Settings
Windows 10, Windows 8.1, Windows 8, Windows 7, Windows Vista	Printer Manages Colors
Windows XP (Service Pack 2 or later and .NET 3.0 or later)	Printer Manages Colors
Windows XP (other than the above)	No Color Management

In other applications, set **No Color Management**.

Note:
 For information on supported platforms, see the website for the application in question.

Setting example for Adobe Photoshop CC

Open the **Print** screen.

Select **Color Management** and then **Document**. Select **Printer Manages Colors** as the **Color Handling** setting, and then click **Print**.

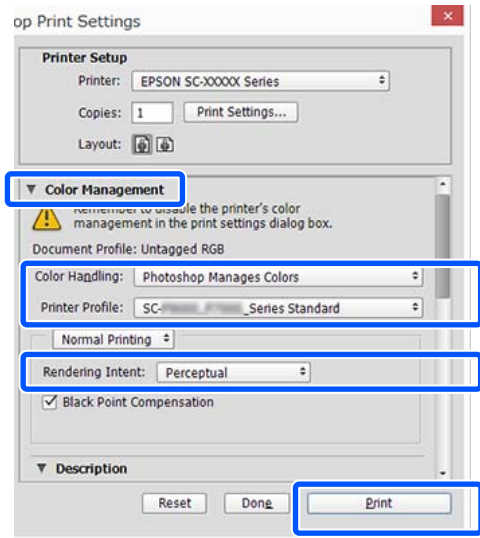

When using applications without a color management function, start from step 2.

2 In the printer driver's **Main** screen, select **Specify Size** as the **Mode**, select **ICM**, and then click **Settings**.

[“Printing \(Windows\)” on page 53](#)

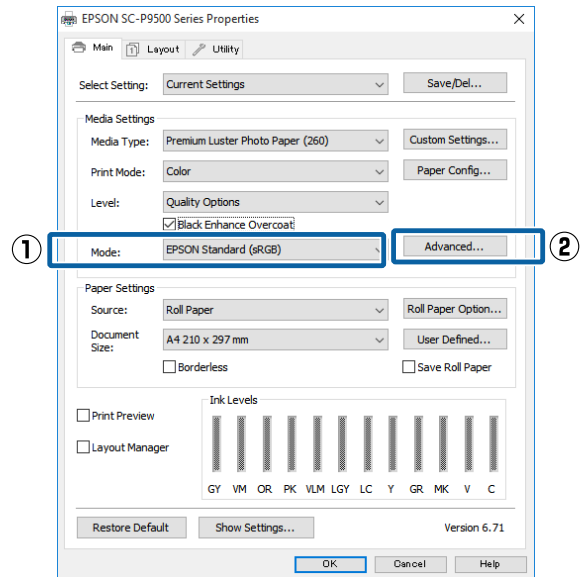

3 Select **ICM Mode** in Printer Color Adjustment. See the printer driver help for more details.

Color Management Printing

When Epson special media is selected for **Media Type** in the **Main** screen, the printer profile corresponding to the media type is automatically selected and displayed in the **Printer Profile Description** box.

To change the profile, select **Show all profiles** at the bottom.

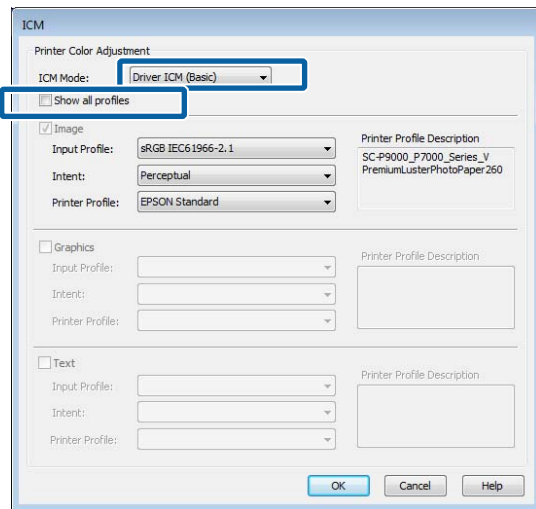

- 4 Check other settings, and then start printing.

Color Management Printing by ColorSync (Mac)

Use image data in which an input profile has been embedded. Also, the application must support ColorSync.

Note:
Depending on the application, color management printing by **ColorSync** may not be supported.

- 1 Disable the color management functions in the application.
- 2 Display the Print screen.
 [“Performing Printing \(Mac\)” on page 54](#)

- 3 Select **Color Matching** from the list, and then click **ColorSync**.

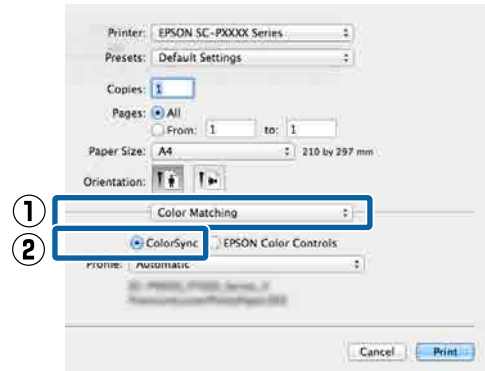

- 4 Check other settings, and then start printing.

Color management printing by Driver ICM (Windows Only)

The printer driver uses its own printer profiles to perform color management. You can use the following two color correction methods.

- Driver ICM (Basic)**
Specify one type of profile and intent for processing the entire image data.
- Driver ICM (Advanced)**
The printer driver distinguishes the image data into the **Image**, **Graphics**, and **Text** areas. Specify three types of profiles and intents for processing each area.

When using applications featuring a color management function

Make the settings for color processing using the application before making printer driver settings.

Depending on the type of the application, make the settings following the table below.

Adobe Photoshop CS3 or later
Adobe Photoshop Elements 6.0 or later
Adobe Photoshop Lightroom 1 or later

Color Management Printing

OS	Color Management Settings
Windows 10, Windows 8.1, Windows 8, Windows 7, Windows Vista	Printer Manages Colors
Windows XP (Service Pack 2 or later and .NET 3.0 or later)	Printer Manages Colors
Windows XP (other than the above)	No Color Management

In other applications, set **No Color Management**.

Note:

For information on supported platforms, see the website for the application in question.

Setting example for Adobe Photoshop CS5

Open the **Print** screen.

Select **Color Management** and then **Document**. Select **Printer Manages Colors** as the **Color Handling** setting, and then click **Print**.

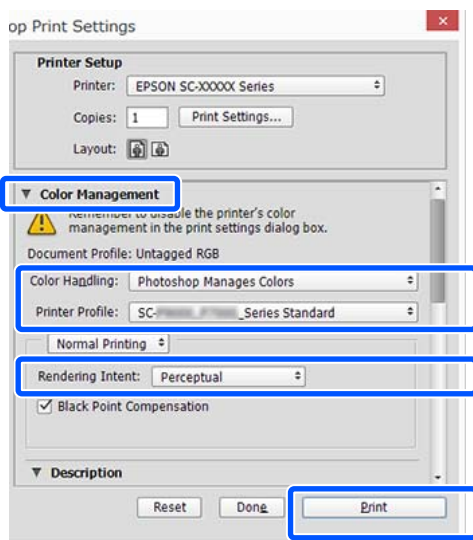

1 In the printer driver's **Main** screen, select **Specify Size** as the **Mode**, select **ICM**, and then click **Settings**.

["Printing \(Windows\)" on page 53](#)

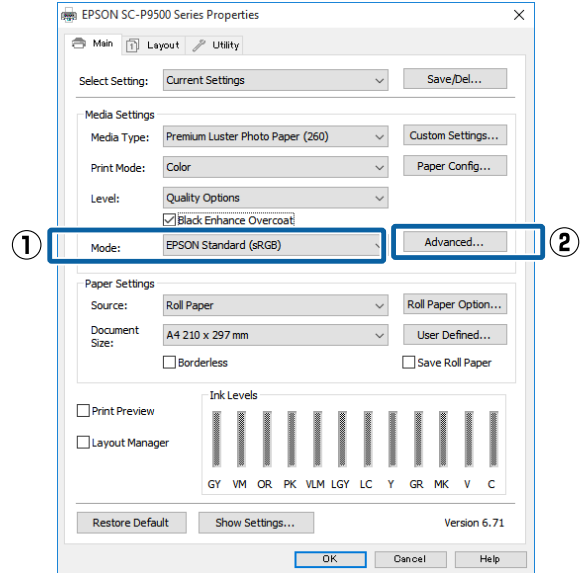

2 From **ICM Mode** in the **ICM** screen, select **Driver ICM (Basic)** or **Driver ICM (Advanced)**.

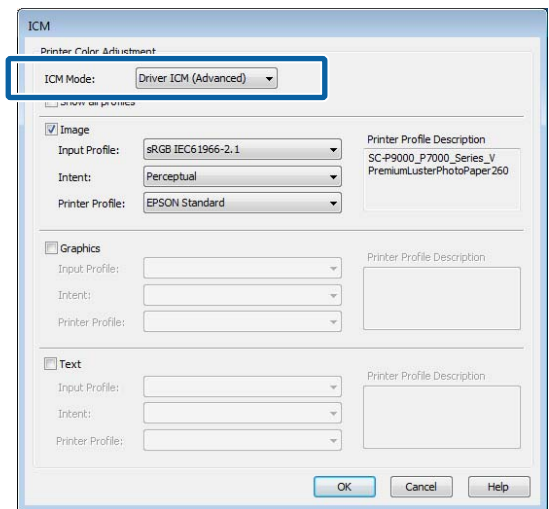

If you select **Driver ICM (Advanced)**, you can specify the profiles and intent for each image such as photos, graphics, and text data.

Intent	Explanation
Saturation	Keeps the current saturation unchanged and converts the data.

Color Management Printing

Intent	Explanation
Perceptual	Converts the data so that a more visually natural image is produced. This feature is used when a wider gamut of color is used for image data.
Relative Colorimetric	Converts the data so that a set of color gamut and white point (or color temperature) coordinates in the original data match their corresponding print coordinates. This feature is used for many types of color matching.
Absolute Colorimetric	Assigns absolute color gamut coordinates to the original and print data and converts the data. Therefore, color tone adjustment is not performed on any white point (or color temperature) for the original or print data. This feature is used for special purposes such as logo color printing.

3

Check other settings, and then start printing.

Menu List

Menu List

Paper Setting

Settings item	Setting/Additional Explanation
Roll Paper	
Remove	Roll paper is ejected. After the paper has been ejected, information on how to remove the roll paper is displayed.
Feed/Cut Paper	Backward, Forward, Cut Touch Cut to cut the paper.
Prepare for Take-up	This item is only displayed when the take-up reel unit is connected. Roll paper take-up preparation starts.
Print Adjustments	
Paper Feed Adjust	Quality First, Length Accuracy First
Print Head Alignment	Uni-D Alignment, Bi-D Alignment You can adjust automatically or manually. Perform print head alignment when the print results look grainy or out-of-focus. Normally, select Auto. If you are not satisfied with the results of auto adjustment, perform manual adjustments. See the following for details on the adjustment method.  "Print Head Alignment" on page 129

Menu List

Settings item	Setting/Additional Explanation
Advanced Paper Settings	
Confirm ICC profile	Displays the ICC profile name. This is only displayed when the optional PS unit is connected and a custom paper is set.
Confirm Color Density	Displays the Color Density. This is only displayed when the optional PS unit is connected and a custom paper is set.
Paper Thickness	0.01 - 1.50 mm (0.01 mm units)/0.4 - 59.1 mil (0.1 mil units) This item is only displayed for Custom Paper Setting.
Platen Gap	Auto, 1.2, 1.6, 1.9, 2.1, 2.4 Select a wider setting if print results are scratched or smudged.
Top Margin	3 mm, 15 mm, 20 mm, 45 mm If the margin at the leading edge of the paper is small, colors may be uneven depending on the paper and printing environment. If this occurs, print a larger margin at the leading edge of the paper.
Bottom Margin	3 mm, 15 mm
Margin Between Pages	Standard, 6 mm, 30 mm, 65 mm
Paper Suction	-4 to +3 Thin or soft paper may not be fed correctly. If this occurs, reduce the setting.
Back Tension	Standard, High, Extra High Adjust this when paper gets wrinkled during printing.
Drying Time	Drying Time per Pass, Drying Time per Page You can set the drying time for each print head movement (pass) or the drying time for each page.
Paper Size Check	Change the setting after loading paper (before the paper is fed).
Auto Cut	Follow Paper Source Settings, Never Cut
Skew Reduction	On, Off Select whether to enable (On) or disable (Off) paper skew reduction while printing on roll paper.
Lateral Feed Adjustment	On, Off Set this to On to correct differences in the left or right of the paper feed.
Paper Eject Roller	Auto, Use, Do Not Use
Roll Core Diameter	2inch, 3inch Set the paper core size for the roll paper being loaded.
Paper Feed Offset	-1.0 to +1.53% This item is only displayed for custom paper.

Menu List

Settings item		Setting/Additional Explanation
	Paper Feed Amount Adjustment	Print Speed Priority, Quality First If image quality declines when printing multiple pages, select Quality First . Additionally, set Printer Settings - Paper Source Settings - Roll Paper Setup - Cut Settings - Quick Cut to Off from the General Settings menu. Selecting Quality First slows down the printing speed.
	Restore Default Settings	The advanced paper settings are saved for the paper type. Select this when you want to restore the default settings. This is not displayed when Custom Paper is selected.
Remaining Amount Management		
	Remaining Amount Management	On, Off
	Remaining Amount	Enter the amount of paper remaining.
	Remaining Alert	A warning is displayed when the amount of remaining roll paper is running low. Enter the amount of remaining roll paper that will trigger the warning.
	Change Paper Type	You can change the set paper type.
Change Paper Type/Paper Width		
	Paper Type	Recently Used Paper, Recently Added Media, More Paper Types (Photo Paper, Proofing Paper, Fine Art Paper, Matte Paper, Canvas, Plain Paper, Others, Custom Paper)
	Paper Width	A Series, US-ANSI, US-ARCH, B Series (ISO), B Series (JIS), Photo Series, Others, User-Defined This item is only displayed when Custom Paper is set and Paper Size Check is turned off.
Cut Sheet		
	Remove	Ejects cut sheets. After the paper is ejected, information on how to remove the cut sheets is displayed.
Print Adjustments		
	Paper Feed Adjust	Quality First, Length Accuracy First
	Print Head Alignment	Uni-D Alignment, Bi-D Alignment You can adjust automatically or manually. Perform print head alignment when the print results look grainy or out-of-focus. Normally, select Auto. If you are not satisfied with the results of auto adjustment, perform manual adjustments. See the following for details on the adjustment method.  "Print Head Alignment" on page 129

Menu List

Settings item	Setting/Additional Explanation
Advanced Paper Settings	
Confirm ICC profile	Displays the ICC profile name. This is only displayed when the optional PS unit is connected and a custom paper is set.
Confirm Color Density	Displays the Color Density. This is only displayed when the optional PS unit is connected and a custom paper is set.
Paper Thickness	0.01 - 1.50 mm (0.01 mm units)/0.4 - 59.1 mil (0.1 mil units) This item is only displayed for Custom Paper Setting.
Platen Gap	Auto, 1.2, 1.6, 1.9, 2.1, 2.4 Select a wider setting if print results are scratched or smudged.
Paper Suction	-4 to +3 Thin or soft paper may not be fed correctly. If this occurs, reduce the setting.
Drying Time	Drying Time per Pass, Drying Time per Page You can set the drying time for each print head movement (pass) or the drying time for each page.
Paper Size Check	On, Off When this is set to On , the width of the loaded paper is automatically detected.
Skew Reduction	On, Off Select whether to enable (On) or disable (Off) paper skew reduction while printing on paper.
Paper Eject Roller	Auto, Use, Do Not Use
Paper Feed Offset	-1.0 to +1.53% This item is only displayed for custom paper.
Restore Default Settings	The advanced paper settings are saved for the paper type. Select this when you want to restore the default settings. This item is not displayed when Custom Paper is selected.
Change Paper Type/Paper Size	
Paper Type	Recently Used Paper, Recently Added Media, More Paper Types (Photo Paper, Proofing Paper, Fine Art Paper, Matte Paper, Canvas, Plain Paper, Others, Custom Paper)
Paper Size	A Series, US-ANSI, US-ARCH, B Series (ISO), B Series (JIS), Photo Series, Others, User-Defined
Poster Board	

Menu List

Settings item	Setting/Additional Explanation
Remove	Poster board is ejected. After the paper has been ejected, information on how to remove the poster board is displayed.
Print Adjustments	
Paper Feed Adjust	Quality First, Length Accuracy First
Print Head Alignment	Uni-D Alignment, Bi-D Alignment You can adjust automatically or manually. Perform print head alignment when the print results look grainy or out-of-focus. Normally, select Auto. If you are not satisfied with the results of auto adjustment, perform manual adjustments. See the following for details on the adjustment method. 🔗 "Print Head Alignment" on page 129
Advanced Paper Settings	
Confirm ICC profile	Displays the ICC profile name. This is only displayed when the optional PS unit is connected and a custom paper is set.
Confirm Color Density	Displays the Color Density. This is only displayed when the optional PS unit is connected and a custom paper is set.
Paper Thickness	0.01 - 1.50 mm This item is only displayed for Custom Paper Setting.
Paper Suction	-4 to +3 Thin or soft paper may not be fed correctly. If this occurs, reduce the setting.
Drying Time	Drying Time per Pass, Drying Time per Page You can set the drying time for each print head movement (pass) or the drying time for each page.
Paper Size Check	On, Off When this is set to On , the width of the loaded paper is automatically detected.
Skew Reduction	On, Off Select whether to enable (On) or disable (Off) paper skew reduction while printing on paper.
Paper Feed Offset	-1.0 to +1.53% This item is only displayed for custom paper.
Restore Default Settings	The advanced paper settings are saved for the paper type. Select this when you want to restore the default settings. This item is not displayed when Custom Paper is selected.
Change Paper Type/Paper Size	
Paper Type	Recently Used Paper, Recently Added Media, More Paper Types (Photo Paper, Proofing Paper, Fine Art Paper, Matte Paper, Canvas, Plain Paper, Others, Custom Paper)
Paper Size	A Series, US-ANSI, US-ARCH, B Series (ISO), B Series (JIS), Photo Series, Others, User-Defined

Menu List

General Settings

Settings item	Setting/Additional Explanation
Basic Settings	
LCD Brightness	1 to 9
Sounds	
Button Press	0 to 10
Paper Set	0 to 10
Completion Notice	0 to 10
Error Notice	0 to 10
Sound Type	Pattern1, Pattern2
Inside Light	Auto, Manual
Alert Lamp Notice	On, Off
Sleep Timer	1 to 60
Power Off Timer	Off, 30minutes, 1h, 2h, 4h, 8h, 12h
Circuit Breaker Interlock Startup	On, Off
Date/Time Settings	Date/Time, Time Difference
Language	Dutch, English, French, German, Italian, Japanese, Korean, Portuguese, Russian, Simplified Chinese, Spanish, Traditional Chinese
Screen Customization	
Background Color	You can change the color of the Home screen.
Print Screen	Professional, Simple
Operation Time Out	When this is set to On , the initial screen is automatically displayed when no operations are performed on the control panel for approximately 90 seconds.
Length Unit	m, ft / in
Default Screen(Job/Status)	When the optional hard disk and PS unit are not connected: Log, Printer Status When the optional hard disk and PS unit are connected: Job Status, Log, Printer Status
Printer Settings	

Menu List

Settings item	Setting/Additional Explanation
Paper Source Settings	
Roll Paper Setup	
Auto Loading	On, Off
Cut Settings	
Auto Cut	On, Off
Print Cutting Guideline	On, Off If Auto Cut is set to Off , you can choose whether or not (On/Off) to print cutting lines on roll paper. Cutting lines are not printed if Auto Cut is set to On or when printing cut sheets or poster board.
Wait for Cut Between Pages	On, Off
Cut for Borderless Print	Two Cuts, One Cut
Quick Cut	On, Off
Cut Mode	Normal, Quiet
Margin Refresh	On, Off Before printing with borders, select whether or not (On/Off) to automatically cut the leading edge to remove ink stains that may have been left by previous borderless printing.
Roll End Option	Continue, Stop Printing, Reprint Select the action to perform for a roll after replacement: print the remaining data (Continue) / do not print (Stop Printing) / print again from the beginning (Reprint). Reprint is only available when the optional hard disk unit is installed.
Take-up After Cut	On, Off This item is only displayed when the take-up reel unit is connected.  "Removing Paper from the Auto Take-up Reel Unit" on page 51
Error Notice	
Paper Size Notice	On, Off
Paper Type Notice	On, Off
Detect Paper Meandering	On, Off
Platen Gap Offset	Standard, Wide, Wider, Widest
Custom Paper Setting	
01 to 30	Display Registered Number & Registered Media Name From the printer, you cannot change paper setting information registered using the driver or other software.
Change Name	Displays the media name registration screen
Change Reference Paper	Displays the reference paper type

Menu List

Settings item	Setting/Additional Explanation
Advanced Paper Settings	
Confirm ICC profile	Displays the ICC profile name. This item is only displayed when the PS option is connected.
Confirm Color Density	Displays the Color Density. This item is only displayed when the PS option is connected.
Paper Thickness	0.01 - 1.50 mm (0.4 - 59.1 mil) (0.01 mm units)
Platen Gap	Auto, 1.2, 1.6, 1.9, 2.1, 2.4
Top Margin	3 mm, 15 mm, 20 mm, 45 mm If the margin at the leading edge of the paper is small, colors may be uneven depending on the paper and printing environment. If this occurs, print a larger margin at the leading edge of the paper.
Bottom Margin	3 mm, 15 mm
Margin Between Pages	Standard, 6 mm, 30 mm, 65 mm
Paper Suction	-4 to +3 Thin or soft paper may not be fed correctly. If this occurs, reduce the setting.
Back Tension	Standard, High, Extra High Adjust this when paper gets wrinkled during printing.
Drying Time	Drying Time per Pass, Drying Time per Page You can set the drying time for each print head movement (pass) or the drying time for each page.
Paper Size Check	On, Off When this is set to On , the width of the loaded paper is automatically detected.
Auto Cut	Follow Paper Source Settings, Never Cut
Skew Reduction	On, Off Select whether to enable (On) or disable (Off) paper skew reduction while printing on paper.
Roll Core Diameter	2inch, 3inch Set the paper core size for the roll paper being loaded.
Lateral Feed Adjustment	On, Off Set this to On to correct differences in the left or right of the paper feed.
Paper Eject Roller	Auto, Use, Do Not Use
Paper Feed Offset	-1.0 to +1.53% This item is only displayed for Custom Paper Setting.

Menu List

Settings item		Setting/Additional Explanation
Auto Cleaning		
On		Set the timing that you want the printer to check the status of the nozzles, and if clogged nozzles are detected. If the nozzles are not clogged, cleaning is not performed.
Standard		Sets normal automatic cleaning.
Custom		You can set the timing and frequency for auto cleaning.
Nozzle Check Schedule		During Print, After Print
Nozzle Check Sensitivity		Standard, High Sensitivity
Nozzle Check Result Notice		On, Off
Off		Turns off auto cleaning.
Printing Language (This is only displayed when the optional PS unit is connected.)		
USB		Auto, PS3
Network		Auto, PS3

Menu List

Settings item	Setting/Additional Explanation
PS3 Menu (This is only displayed when the optional PS unit is connected.)	
Version	Displays the PostScript/PDF version.
Output Size	Auto, A Series, US-ANSI, US-ARCH, B Series (ISO), B Series (JIS), Photo Series, Others, User-Defined
Margin Options	Standard, Add Margins, Clip By Margins Select the difference between the size of the print data and the size of the output paper.
Quality	Draft, Standard, Fine
Color Mode	Color, B&W Only displayed when a paper type that supports color printing and monochrome printing is selected.
CMYK Simulation	You can select the CMYK ink color you want to simulate when reproducing CMYK ink colors for an offset printer.
RGB Source	When printing RGB data, you can select the RGB color definition you want to simulate.
Rendering Intent	Absolute, Relative, Perceptual, Saturation You can select how to convert color spaces during CMYK simulations and RGM simulations.
Black Point Compensation	On, Off Normally, select On . Select Off if you notice that shadows are too bright when converting from a wide color space to a narrow color space.
Auto Rotate	On, Off When this is set to On , the print data is automatically rotated 90 degrees to the right depending on conditions such as the paper width and data size.
Caching To HDD	On, Off Normally, select Off . Set this to On if the print head stops frequently while printing. This may solve the problem.
Save To HDD	Print And Save, Print Only, Save Only
PS Error Sheet	On, Off When this is set to On , the contents of the error are printed when a PostScript error occurs.
Optimize Edge Quality	On, Off When this is set to On, everything is printed in single head mode. The print quality at the edges is improved, but the print speed is reduced and the margin at the leading edge is increased by about 35 mm compared to when this is set to Off. When this is set to Off, everything is printed in dual head mode. Select On if you are worried about the print quality at the leading edge of the paper.
PDF Rendering Level	Level 1 to 5 Normally, this is set to 5. Although this may create a PS that reproduces the PDF as faithfully as possible, you may not be able to print. If this occurs, try lowering the rendering level.
Clear All Settings	Restore 120 PS settings to their default settings.

Menu List



Settings item	Setting/Additional Explanation
Print Nozzle Check Pattern during Print	Every Pages, Off Prints a nozzle check pattern for any page. When this is set, a check pattern for clogged nozzles is printed at the top of the page. See the following for details on the nozzle check pattern.  "Print Head Nozzle Check" on page 125
Store Held Job	On, Off Only available when the optional hard disk unit is installed. When this is set to Off, an error occurs and printing is suspended if there are any differences between items such as the paper source settings and the print job settings. When this is set to On, printing is not suspended when an error occurs. Also, print jobs that do not match the print settings are saved to the hard disk as Held Jobs. Saved held jobs can be resumed from the Print Job menu after performing operations such as replacing the paper.
PC Connection via USB	Enable, Disable
USB I/F Timeout Setting	20 to 600 seconds This is only displayed when the optional PS unit is connected.
all Wi-Fi/network settings	
Network Status	
Wired LAN Status	Displays the network connection status.
Print Status Sheet	Prints a network status sheet.
Connection Check	Diagnoses the network connection status.
Advanced	
Device Name	Displays the device name.
TCP/IP	Set the IP address of the printer.
Proxy Server	Use, Do Not Use When this is set to Use, you can configure a proxy server.
IPv6 Address	Enable, Disable Select whether to enable or disable the IPv6 function.
Link Speed & Duplex	Auto, 100BASE-TX Auto, 10BASE-T Half Duplex, 10BASE-T Full Duplex, 100BASE-TX Half Duplex, 100BASE-TX Full Duplex
Redirect HTTP to HTTPS	Enable, Disable When this is set to Enable , HTTP is automatically converted to HTTPS for access.
Disable IPsec/IP Filtering	Enable, Disable
Disable IEEE802.1X	Displays the disabled IEEE802.1X settings.
System Administration	

Menu List

Settings item	Setting/Additional Explanation
Security Settings	
Admin Settings	
Admin Password	Register, Change, Clear All Settings
Lock Setting	On, Off
Password Encryption	<p>On, Off</p> <p>Select On to encrypt the password. You need to restart the printer to apply the password encryption settings. Do not turn off the power while the printer is restarting. If the power does turn off while the printer is restarting, you need to set the password again.</p> <p>Keep the Admin Password in a safe place. If you forget the password, contact your dealer or Epson Support.</p>
Format Hard Disk	<p>Non-Secure (Quick), Secure (Quick), Secure (Sanitizing)</p> <p>This is only displayed when the optional HDD is installed. You can select from the following three types of formatting.</p> <ul style="list-style-type: none"> <input type="checkbox"/> Non-Secure (Quick): Deletes file management information for data on the hard disk. Use this when you want to use the printer with a hard disk that has been used with other printers. <input type="checkbox"/> Secure (Quick): Overwrites the entire hard disk with a random character pattern. Erases data more securely than Non-Secure (Quick). However, it is possible that data could be recovered by using a dedicated data recovery tool. <input type="checkbox"/> Secure (Sanitizing): Overwrites data with random 00/FF/ data, and then checks using an algorithm based on the U.S. Department of Defense standard (DoD5220-22m). This option takes longer than the others to finish formatting, however it does provide the securest method of erasing data. Select this when you need to erase confidential data.
Paper Feed Adjustment Mode	
RIP Priority	<p>On, Off</p> <p>When On is selected, paper feed adjustment is performed while prioritizing RIP information. Set this to On if the print position shifts when using a RIP from another company. Set this to Off if you are not using a RIP from another company.</p> <p> "Problem Solver" on page 139</p>
Restore Default Settings	all Wi-Fi/network settings, Clear All Data and Settings



Supply Status

Displays the amount of ink remaining or the model number and amount of free space in the maintenance box.

 is displayed when the amount of ink remaining or the amount of free space in the maintenance box is running low. Even if  is displayed, you can continue printing until you are instructed to replace the part. Prepare new cartridges or a maintenance box as soon as possible.

Menu List

Maintenance

Settings item	Setting/Additional Explanation
Print Head Nozzle Check	Select the paper feed method to print the nozzle check pattern. See the following for details on the nozzle check pattern.  "Print Head Nozzle Check" on page 125
Head Cleaning	Cleans the selected color. Only run this when the nozzles are clogged.  "Cleaning the print head" on page 127
Power Cleaning	Cleans the selected color. Only run this when you cannot clear the clogged nozzles even after repeating normal print head cleaning several times.  "Cleaning the print head" on page 127
Remove Paper	Removes any scraps of paper that remain inside the printer.
Ink Cartridge(s) Replacement	Displays the amount of ink remaining and the model number for the cartridge. Touch How To... to view the replacement instructions on the screen.
Replace Maintenance Box	Displays the amount of free space remaining and the model number of the maintenance box. Touch How To... to view the replacement instructions on the screen.
Replace Cutter	You can replace the cutter. Touch How To... to view the replacement instructions on the screen.
Adjust Cut Position	-3.0 to +3.0 mm
SpectroProofer Setting	This is only displayed when a SpectroProofer is installed.
Cleaning the Maintenance Parts	
Wiping the Print Head	You can clean the print head. Touch Start to move the print head to the cleaning position.
Wiping around the Cap	You can clean around the caps. Touch Start to move the print head to the cleaning position.
Keeping/Transporting Preparation	
Keeping Preparation	Touch Start to discharge ink. When the ink has been discharged, the printer is automatically turned off.
Personal Transport Preparation	Touch Start to discharge ink. When the ink has been discharged, the printer is automatically turned off.

Language

You can select the language displayed on the panel. Select from the following languages.

Menu List

Dutch, English, French, German, Italian, Japanese, Korean, Portuguese, Russian, Simplified Chinese, Spanish, Traditional Chinese

Status

Settings item	Setting/Additional Explanation
Firmware Version	Displays the firmware versions for the printer, Adobe PS3 expansion unit, SpectroProofer mounter, ILS30EP, and the auto take-up unit.
Hard Disk Unit	Displays the connection status for the hard disk unit.
Adobe PS3 Expansion Unit	Displays the connection status for the Adobe PS3 expansion unit.
SpectroProofer	Calibration Tile S/N, Device Temperature, Air Temperature, Backing Color This is only displayed when a SpectroProofer is installed.
Auto Take-up Reel Unit	Only displayed when the auto take-up reel unit is installed.
Platen Gap Value for Last Print Job	Displays the platen gap value the last time printing was performed.
Network	You can display the LAN connection status and print a status sheet.

Maintenance

Print Head Maintenance

You need to perform print head maintenance if white lines appear in your print outs or if you notice the print quality has declined.

Maintenance Operations

You can perform the following printer maintenance functions for maintaining the print head in good condition to ensure the best print quality. Carry out appropriate maintenance depending on the print results and situation.

Auto Cleaning

When this is set to On, the printer automatically checks for clogged nozzles and performs cleaning if it detects clogged nozzles.

Note:

- ❑ This function does not guarantee 100% detection of clogged nozzles.
- ❑ A small amount of ink is consumed when detecting clogged nozzles.
- ❑ Ink is consumed when performing automatic cleaning.

You can change the timing for the nozzle check in Auto Cleaning. Set this to Off if you do not want to perform auto cleaning.

[“General Settings” on page 116](#)

Note:

Even when Auto Cleaning is set to Off, auto cleaning may be performed to maintain printer quality.

Print Head Nozzle Check

Print a nozzle check pattern to check for clogged nozzles if you have not used the printer for an extended period or before printing an important job. Visually inspect the printed check pattern and clean the print head if you notice faint or missing areas.

[“Print Head Nozzle Check” on page 125](#)

Cleaning the print head

Use this if you notice faint or missing areas in the prints. Cleans the surface of the print head to improve the print quality. There are two types of cleaning available depending on the level of cleaning required; normal head cleaning and powerful head cleaning.

[“Cleaning the print head” on page 127](#)

Normally, perform Normal head cleaning. If nozzles are clogged even after performing Normal head cleaning several times, perform Powerful Cleaning.

Print Head Alignment

Adjust the position of the print head when lines are misaligned or when the print results appear grainy. Print Head Alignment corrects print head misalignments during printing.

[“Print Head Alignment” on page 129](#)

Adjusting the paper feed (Paper Feed Adjust)

Use this setting if you are unable to resolve banding issues (horizontal striped lines or uneven colors) in the standard print area (for cut sheets, the area excluding the 1 to 2 cm strip at the bottom of the paper) even after cleaning the print head or performing head alignment.

[“Paper Feed Adjust” on page 132](#)

Print Head Nozzle Check

Nozzle checks can be performing from a computer or using printer's control panel.

From the printer

1

Make sure that the roll paper or a cut sheet of A4 size or larger is loaded in the printer.

[“Loading and Removing the Roll Paper” on page 30](#)

[“Loading and Removing Cut Sheets/Poster Board” on page 37](#)

Maintenance

- 2 Choose a paper type that matches the paper in the printer.

 [“Setting Loaded Paper” on page 38](#)

- 3 Touch **Menu - Maintenance - Print Head Nozzle Check**.

- 4 Touch **Start** to start printing a check pattern.

- 5 Review the printed check pattern while referring to the following section.

Example of clean nozzles

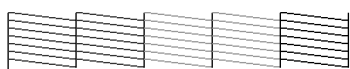

If none of the pattern is missing, then the print head nozzles are not clogged. Touch  to end the nozzle clogging check.

Example of clogged nozzles

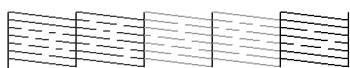

If any segments are missing in the nozzle check pattern, touch  to perform head cleaning.

- 6 Select the row of nozzles you want to clean, and then touch **OK**.

Cleaning starts. Cleaning takes about 4 to 9 minutes.

Note:

The more color pairs selected, the longer it takes to perform cleaning. Also, depending on the status of the nozzles, it can take up to about 32 minutes.

- 7 Follow the on-screen instructions to print a check pattern, and inspect the results to determine if the problem has been resolved.

From the computer

Explanations in this section use the Windows printer driver as an example.

Use Epson Printer Utility 4 for Mac.

 [“Epson Printer Utility 4 Functions” on page 72](#)

- 1 Make sure that the roll paper or a cut sheet of A4 size or larger is loaded in the printer.

 [“Loading and Removing the Roll Paper” on page 30](#)

 [“Loading and Removing Cut Sheets/Poster Board” on page 37](#)

- 2 Choose a paper type that matches the paper in the printer.

 [“Setting Loaded Paper” on page 38](#)

- 3 Click **Nozzle Check** from the **Utility** tab in the printer driver's **Properties** (or **Printing preferences**) screen.

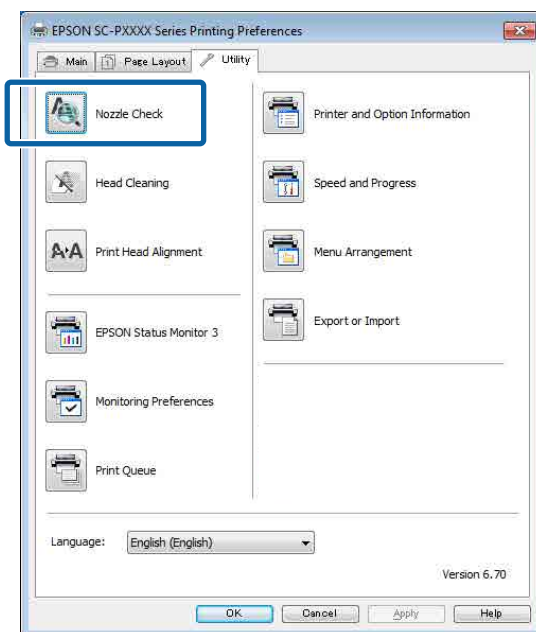

- 4 Click **Print**.

The nozzle check pattern is printed.

- 5 Check the nozzle check pattern.

If there is no problem: click **Finish**.

If there is a problem: click **Clean**.

After printing a nozzle check pattern, make sure that the nozzle check pattern printing is complete before printing your data or cleaning the print head.

Maintenance

Cleaning the print head

Although head cleaning can be performed from the computer or the printer, the cleaning procedures differ as explained below.

From the printer

You can select two levels of cleaning strength.

 [“From the printer” on page 127](#)

From the computer

 [“From the computer” on page 128](#)

Notes on Print Head Cleaning

Ink is consumed during head cleaning.

Clean the print head only if print quality declines; for example, if the printout is blurry or the color is incorrect or missing.

When cleaning all nozzles, ink is consumed from all colors.

Even if you are using only black inks for black and white printing, color inks are also consumed.

Prepare a new maintenance box if there is not enough empty space in the box.

If you repeat head cleaning several times in a short period, the ink in the maintenance box may become full soon as ink does not evaporate quickly from the maintenance box.

Power Cleaning consumes much more ink than Print Head Cleaning in the Maintenance menu.

Check the remaining ink level in advance, and prepare a new ink cartridge before you start cleaning if the ink is low.

Print head cleaning cannot be performed unless the temperature conditions are correct. See the following for the appropriate temperature conditions.

 [“Specifications Table” on page 188](#)

If the nozzles are still clogged after performing Power Cleaning, turn off the printer and leave it overnight or longer.

When left for some time, the clogged ink may dissolve.

If the nozzles are still clogged, contact your dealer or Epson Support.

From the printer

Before starting this procedure, be sure to read the following:

 [“Notes on Print Head Cleaning” on page 127](#)

- 1** Select **Menu - Maintenance - Cleaning the Maintenance Parts - Wiping the Print Head** on the control panel.
- 2** Select nozzle arrays for cleaning.
Select the color pairs with faint or missing segments in the check pattern.
- 3** Touch **OK** to start cleaning.
Head cleaning takes about 4 to 9 minutes.

Note:

The more color pairs selected, the longer it takes to perform cleaning. Depending on the status of the nozzles and the Auto Clean Max Repeat setting, this function can take up to 32 minutes.

A confirmation message is displayed when cleaning is complete.

- 4** Touch **Yes** to print a check pattern and check for clogging.
If you do not want to perform a nozzle check, touch **No** to exit.

If the nozzles are still clogged, repeat steps 1 to 3 several times. If you cannot clear the clogged nozzles even after repeating cleaning several times, see the following to perform **Power Cleaning**.

Power Cleaning

Before starting this procedure, be sure to read the following:

Maintenance

 [“Notes on Print Head Cleaning” on page 127](#)

- 1 Select **Menu - Maintenance - Power Cleaning** on the control panel.
- 2 Select the nozzle arrays for Power Cleaning.
Select the color pairs with faint or missing segments in the check pattern.
- 3 Press the **OK** button to start Power Cleaning.
Power Cleaning takes about 8 minutes.

Note:

The more color pairs selected, the longer it takes to perform cleaning. Also, depending on the status of the nozzles, it can take up to about 27 minutes.

When Power Cleaning is complete, you are returned to the screen displayed before cleaning was performed.

- 4 Touch **Yes** to print a check pattern and check for clogging.
If you do not want to perform a nozzle check, touch **No** to exit.

From the computer

Before starting this procedure, be sure to read the following:

 [“Notes on Print Head Cleaning” on page 127](#)

Explanations in this section use the Windows printer driver as an example.

Use Epson Printer Utility 4 for Mac.

 [“Using Epson Printer Utility 4” on page 72](#)

1

Click **Head Cleaning** from the **Utility** tab in the printer driver's **Properties** (or **Printing preferences**) screen.

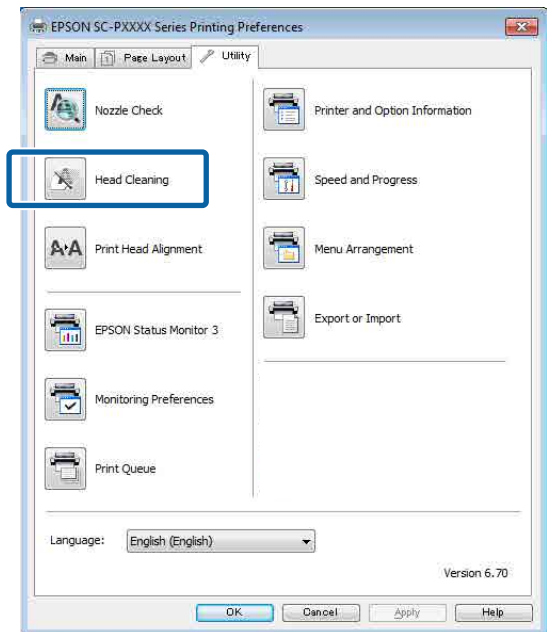

Select **Clean All Colors** to clean all of the print heads (nozzles).

When you select **Auto Select**, a nozzle check is performed and only the clogged print heads (nozzles) are cleaned. Cleaning is not performed if the print heads (nozzles) are not clogged.

2

Click **Start**.

Head cleaning starts. Head cleaning takes about 4 to 9 minutes.

Note:

*When **Auto Cleaning** is set to **On**, the nozzles are checked after head cleaning, and if clogging is detected, auto cleaning is performed. Depending on the status of the nozzles and the **Auto Clean Max Repeat** setting, this function can take up to 32 minutes.*

3

Click **Print Nozzle Check Pattern**.

Confirm the nozzle check pattern.

If you see any faint or missing segments in the nozzle check pattern, click **Cleaning**.

If you cannot clear the clogged nozzles even after repeating cleaning several times in succession, select **Power Cleaning** from **Print Head Cleaning** on the printer's control panel.

Maintenance

[“From the printer” on page 127](#)

Print Head Alignment

If lines are misaligned or print results are grainy, perform Print Head Alignment.

The print head fires ink when moving to the left and to the right while printing. Since there is a short distance (gap) between the paper surface and the print head, a print misalignment may occur due to the paper thickness, changes in temperature or humidity, and internal inertia while the print head moves.

Select from Uni-D Alignment or Bi-D Alignment.

Item Name	Explanation
Uni-D Alignment	Adjusts differences in the print position for each color.
Bi-D Alignment	Adjusts differences in the print position for bi-directional printing for each color.

You can also select automatic adjustment and manual adjustment for each menu.

- Auto adjustment
We normally recommend using this method as it rarely causes any problems and is easy to execute. It takes about 13 to 45 minutes to complete the adjustments. The time required varies depending on the menu selected.
- Manual adjustment
Use this if you cannot perform auto adjustment, or if you are not satisfied with the adjustment results when using Auto. Visually check the adjustment patterns printed on the paper, and enter the optimal adjustment values.

Notes on print head alignment

Adjustments are made depending on the paper loaded in the printer.

Make sure that the paper is loaded correctly, and that a **Select Paper Type** is selected.

[“Loading and Removing the Roll Paper” on page 30](#)

[“Loading and Removing Cut Sheets/Poster Board” on page 37](#)

When adjusting using commercially available paper, make sure you register the custom paper in advance.

[“Before Printing on Commercially Available Paper” on page 180](#)

Make sure that nozzles are not clogged.

If nozzles are clogged, adjustment may not be performed correctly. Print the check pattern, perform a visual inspection, and perform head cleaning if necessary.

[“Print Head Nozzle Check” on page 125](#)

Auto adjustment cannot be performed when using the following paper.

- Plain Paper
- Enhanced Matte Poster Board
- Transparent or colored paper

Perform manual adjustment when using these types of paper.

[“Adjusting the print head position” on page 129](#)

When performing auto adjustment, make sure that no external light (direct sunlight) enters the printer.

Otherwise, the printer’s sensors may not read the adjustment pattern correctly. If auto adjustment cannot be performed even after making sure no external light is entering the printer, perform manual adjustment.

[“Adjusting the print head position” on page 129](#)

Adjusting the print head position

Before starting this procedure, be sure to read the following:

[“Notes on print head alignment” on page 129](#)

Maintenance

1 When automatically adjusting the print head position, load paper with a width of 388 mm or more. When manually adjusting the print head position, load paper of A4 size or more.

When adjusting using commercially available paper, make sure you register the Custom Paper in advance.

"Before Printing on Commercially Available Paper" on page 180

2 Choose a paper type that matches the paper in the printer.

"Setting Loaded Paper" on page 38

3 Select **Menu - Paper Setting - Print Adjustments - Print Head Alignment** on the control panel.

4 Select **Uni-D Alignment** or **Bi-D Alignment**.

Item Name	Explanation
Uni-D Alignment	Adjusts differences in the print position for each color. It takes about 35 to 45 minutes to complete the adjustments. The time required varies depending on the menu selected.
Bi-D Alignment	Adjusts differences in the print position for bi-directional printing for each color. It takes about 13 to 18 minutes to complete the adjustments. The time required varies depending on the menu selected.

5 Select Auto or Manual.

When you select Auto, go to step 6.

When you select Manual, go to step 7.

Item Name	Explanation
Auto	The sensor reads the adjustment pattern printed on the paper, and automatically registers the optimum adjustment value to the printer. This method is normally recommended.

Item Name	Explanation
Manual	Visually check the adjustment patterns printed on the paper, and enter the optimal adjustment values. Use this if you cannot perform auto adjustment, or if you are not satisfied with the adjustment results when using Auto.

6 Press **Start** to start adjusting the position of the print head.

The sensor reads the adjustment pattern while it is printing, and automatically registers the optimum adjustment value to the printer.

When adjustment is complete, you are returned to the screen displayed before head alignment was performed. Check the adjustment results to confirm if graininess or misalignment recurs in the printed image.

If you are not satisfied with the results of the adjustment, try adjusting manually.

7 Press **Start** to start adjusting the position of the print head.

The adjustment pattern is printed on the loaded paper.

Note:
Multiple adjustment patterns are printed for cut sheets. Once printing the first sheet is complete, load the next sheet of paper.

8 Check the printed adjustment pattern, and then enter the set value into the control panel.

Uni-D Alignment

(1) Check the adjustment position for #1 VLM1.

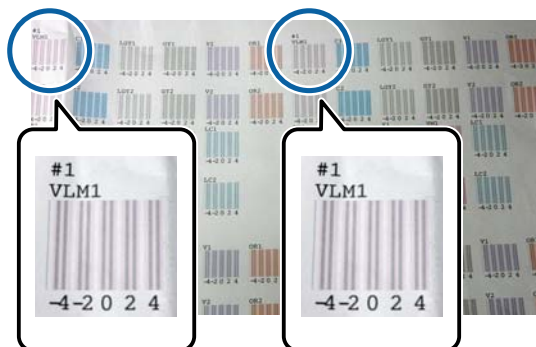

Maintenance

In the photo above, you can see #1 VLM1 in two places, but the number printed varies depending on the paper width.

(2) Note the numbers of the patterns with the fewest white lines or in which the white lines are most evenly spaced.
In the following example image, "0" is the best choice.

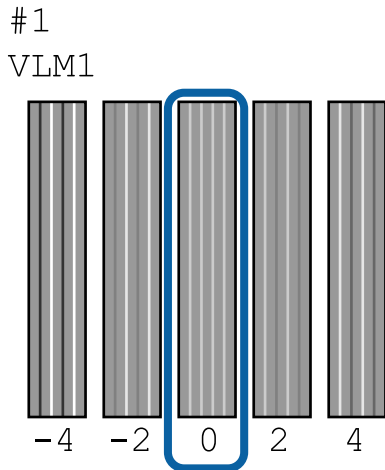

(3) Find the average value of all #1 VLM1 adjustment patterns.

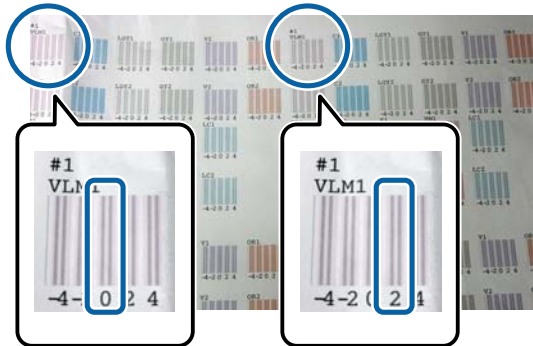

$$(0+2) / 2 = 1$$

If the values you found are not whole numbers, round to the nearest whole number.

$$(1+2) / 2 = 1.5 \rightarrow 2$$

- (4) Enter the setting value on the control panel.
- (5) Follow the instructions on the panel to enter the setting value for all colors in the same way.

Bi-D Alignment

(1) Check the adjustment position for #1 A.



In the photo above, you can see #1 A in two places, but the number printed varies depending on the paper width.

(2) Note the number of the pattern with the fewest lines (the lines essentially overlap).
In the following example image, "0" is the best choice.

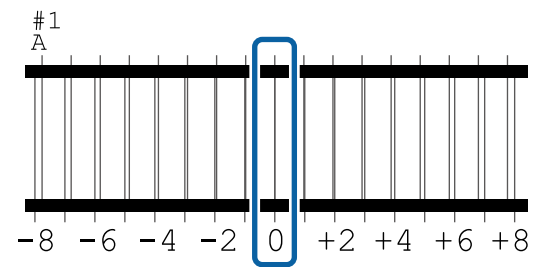

(3) Find the average value of all #1 A adjustment patterns.

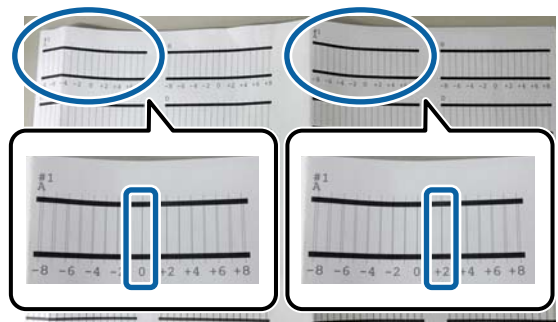

$$(0+2) / 2 = 1$$

Maintenance

If the values you found are not whole numbers, round to the nearest whole number.

$$(1+2) / 2 = 1.5 \rightarrow 2$$

(4) Enter the setting value on the control panel.

(5) Follow the instructions on the panel to enter the setting value for all colors in the same way.

- 9** After entering values for all ink colors, you are returned to the screen displayed before head alignment was performed. Check the adjustment results to confirm if graininess or misalignment recurs in the printed image.

Note:

You can only save one adjustment result. Since you cannot save the adjustment results for each paper type, when you do change the paper type, try printing using the current settings without adjusting the print head position right away.

Only adjust the print head position along with the changed paper type when the lines are misaligned or the print results are noticeably grainy.

Paper Feed Adjust

Use this setting if you are unable to resolve banding issues (horizontal striped lines or uneven colors) in the standard print area (for cut sheets, the area excluding the 1 to 2 cm strip at the bottom of the paper) even after cleaning the print head or performing head alignment.

Select from **Quality First** and **Length Accuracy First** for adjustment. We normally recommend adjusting using **Quality First**.

Quality First

The adjustment patterns are printed. Make adjustments while visually checking the adjustment patterns. This is suitable for printing images that require an emphasis on image quality.

Length Accuracy First

Prints the measurement positions. Measure and adjust the distance for the measurement positions. This is suitable for printing images that require an emphasis on dimensions and length such as CAD.

Selecting paper feed adjustment

- 1** Load the paper.
Load paper that is 400 mm or wider and 560 mm or longer.
[“Loading and Removing the Roll Paper” on page 30](#)
[“Loading and Removing Cut Sheets/Poster Board” on page 37](#)
When adjusting using commercially available paper, make sure you register the Custom Paper in advance.
[“Before Printing on Commercially Available Paper” on page 180](#)
- 2** Choose a paper type that matches the paper in the printer.
[“Setting Loaded Paper” on page 38](#)
- 3** Select **Menu - Paper Setting - Print Adjustments - Paper Feed Adjust** on the control panel.
- 4** Select **Quality First** or **Length Accuracy First**.
- 5** Touch **Start** button to print an adjustment pattern or measurement positions.
- 6** Check the printed adjustment pattern or measurement positions, and then enter the set value into the control panel.

Quality First

(1) Check the adjustment pattern. Look for the pattern with the least visible lines and note the pattern number. For example, the following illustration shows that "0" has the least lines. Enter "0" into the control panel, and then press **OK**.

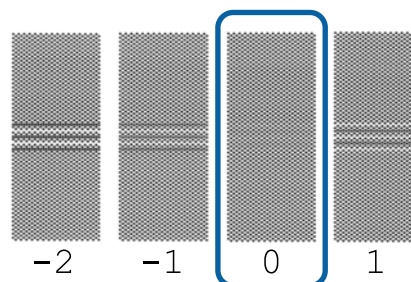

Maintenance

(2) the second adjustment pattern is printed. Check the adjustment pattern in the same way as (1).

Note:**When lines are visible in all adjustment patterns**

*If there are visible lines in all of the adjustment patterns printed when **Quality First** is selected, repeat paper feed correction until a pattern with no visible stripes is printed near the center of the adjustment pattern.*

Length Accuracy First

(1) Measure the distance of the measurement positions with a ruler. Use a ruler that can measure in increments of 0.5 mm.

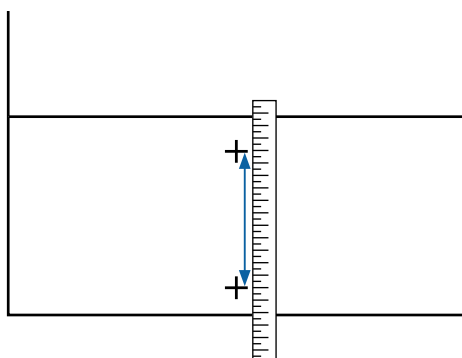

(2) Enter the measurement positions into the control panel, and then press **OK**.

Replacing Consumables

Replacing Ink Cartridges

If one of the installed ink cartridges is expended, printing cannot be performed.

If an ink cartridge is expended while printing, you can continue printing after replacing the ink cartridge.

If you continue to use ink cartridges that are running low, you may need to replace the ink cartridge while printing. If you replace the ink cartridge while printing, colors may look different depending on how the ink dries. If you want to avoid issues such as this, we recommend replacing the cartridge before printing. You can still use the removed ink cartridge in the future until the ink cartridge is expended.

Supported ink cartridges

 [“Options and Consumable Products” on page 163](#)

How to replace

You can use the same procedure to replace all ink cartridges.

Important:

Epson recommends the use of genuine Epson ink cartridges. Epson cannot guarantee the quality or reliability of non-genuine ink. The use of non-genuine ink may cause damage that is not covered by Epson's warranties, and under certain circumstances, may cause erratic printer behavior. Information about non-genuine ink levels may not be displayed, and use of non-genuine ink is recorded for possible use in service support.

Note:

*You can replace the Maintenance Box while viewing the procedure on the screen. To view the procedure on the screen, touch **MENU - Maintenance - Ink Cartridge(s) Replacement** from the Home screen.*

Maintenance

- 1** Open the ink cover.

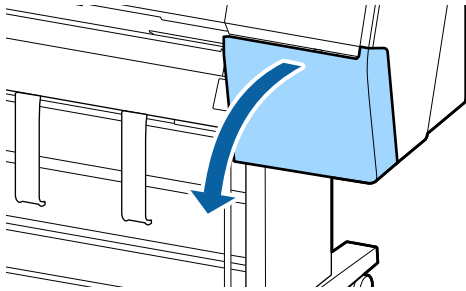

- 2** Pull out the ink cartridge.

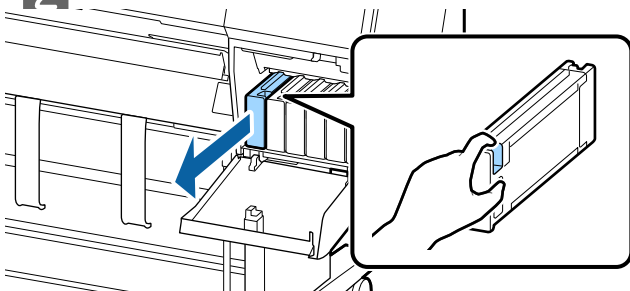

! **Important:**

Removed ink cartridges may have ink around the ink supply port, so be careful not to get any ink on the surrounding area when removing the cartridges.

- 3** Remove the new ink cartridge from the bag. Shake the ink cartridge for 10 seconds 30 times horizontally in approximately 10 cm movements as shown in the illustration.

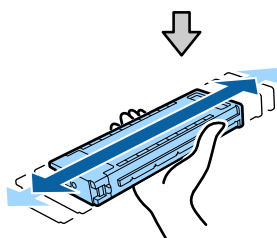

! **Important:**

Do not touch the IC chips on the ink cartridges. You may not be able to print properly.

- 4** Push the ink cartridge in firmly.

Match the color of the ink cartridge to the color of the label on the back of the ink cover.

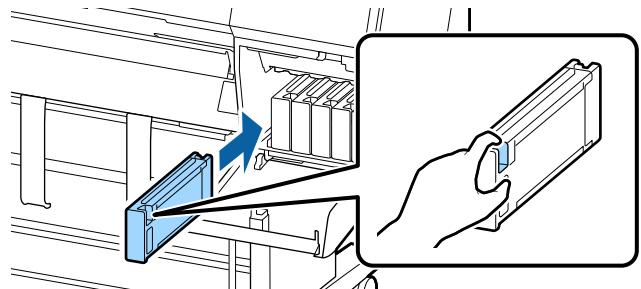

! **Important:**

Install all ink cartridges into each slot. You cannot print if any of the slots are empty.

- 5** Close the ink cover.

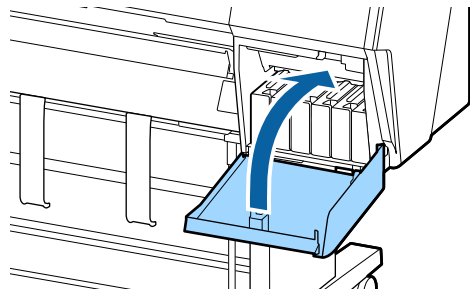

Replacing Maintenance Box

If a message is displayed warning you that there is not enough space in the maintenance box, replace the specified Maintenance Box.

Supported Maintenance Box

[“Options and Consumable Products” on page 163](#)

! **Important:**

Do not reuse maintenance boxes that have been removed and left out in the open for a long period of time. The ink on the inside will be dry and hard and will be unable to absorb enough ink.

How to replace the Maintenance Box

The following shows the number of maintenance boxes and the installation positions.

Maintenance

SC-P9500 Series: 2 (left and right)

SC-P7500 Series: 1 (right only)

Replace the Maintenance Box on the side with the **Not Enough Space** message displayed. The replacement procedure is the same for both sides. When you need to replace both sides, repeat Steps 2 to 5.

! **Important:**

Do not replace the Maintenance Box while printing. Waste ink may leak.

Note:

*You can replace the Maintenance Box while viewing the procedure on the screen. To view the procedure on the screen, touch **MENU - Maintenance - Replace Maintenance Box** from the Home screen.*

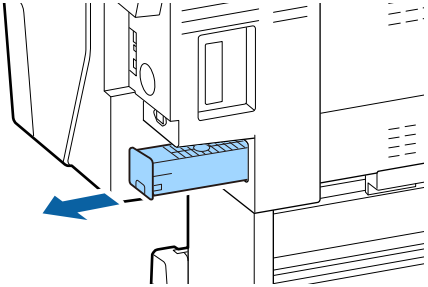
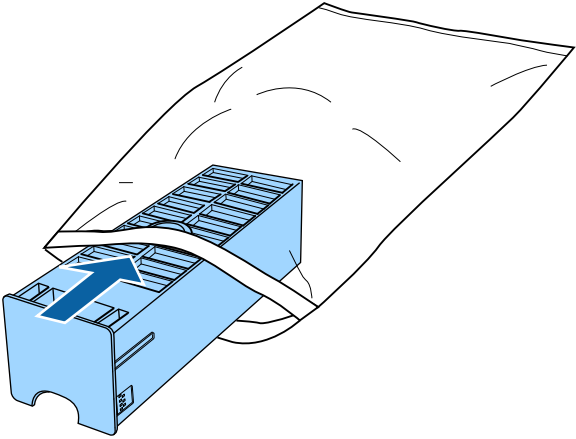
- 1** Remove the new maintenance box from the package.
- 2** Remove the maintenance box without tilting it.
 
- 3** Place the used maintenance box in the clear bag included with your new maintenance box, and make sure that the zipper is closed tight.
 

- 4** Insert the new maintenance box.

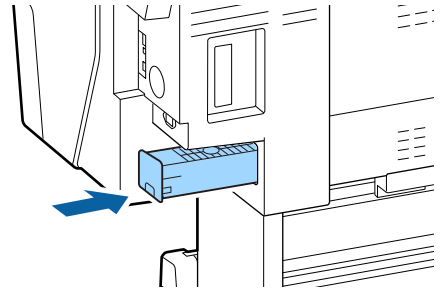

! **Important:**

Do not touch the IC chip on the maintenance box. Doing so may prevent normal operation and printing.

Replacing the Cutter

Replace the cutter when it is not cutting paper cleanly.

Supported cutter

 ["Options and Consumable Products" on page 163](#)

Use a cross-head screwdriver to replace the cutter. Make sure you have a cross-head screwdriver with you before replacing the cutter.

! **Important:**

Take care not to damage the cutter blade. Dropping it or knocking it against hard objects may chip the blade.

When the SpectroProofer mouter (option) is installed

You cannot open the cutter replacement cover when the SpectroProofer mouter is installed. Remove the SpectroProofer mouter before replacing the cutter, and then reinstall it afterwards. When removing, see the manual supplied with the mouter, and then follow the procedure in reverse to reinstall it.

 ["SpectroProofer Mouter 24"/44" Setup Guide" \(booklet\)](#)

- 1** Remove any paper from the printer.

 ["Removing Roll Paper" on page 35](#)

Maintenance

 “Removing Cut Sheets/Poster Board” on page 38

2 From the Home screen, touch **Menu - Maintenance - Replace Cutter**.

3 Touch **Start** to move the cutter to the replacement position.

4 Press down the knob on the cutter replacement cover, and pull it down and towards you to remove.

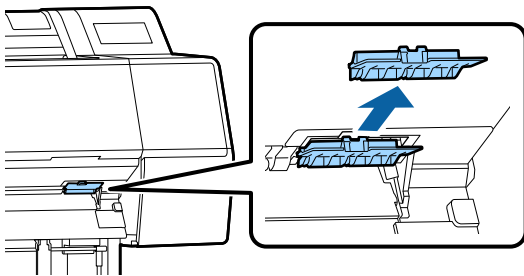

5 Loosen the screw that secures the cutter with a cross-head screwdriver.

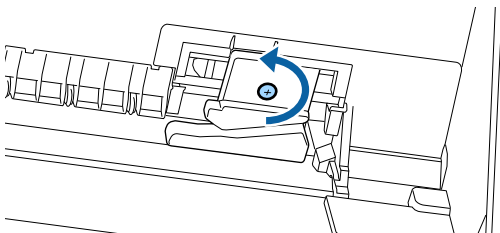

6 Remove the old cutter from the printer.

 **Caution:**

Do not store the cutter within the reach of children. The cutter's blade could cause an injury. Pay careful attention when replacing the cutter.

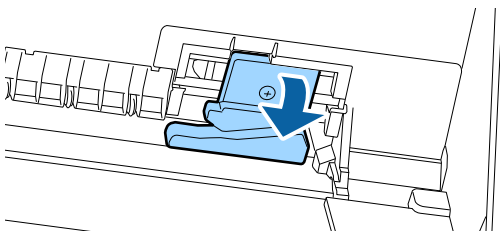

7 Install the new cutter.

Insert a screw into the cutter side of the hole on the printer.

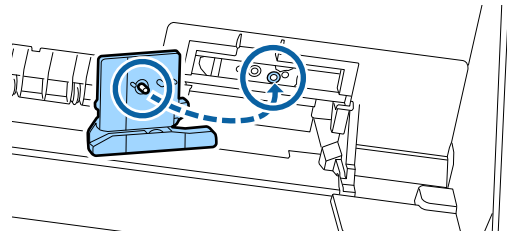

8 Tighten the screw with a cross-head screwdriver to secure the cutter.

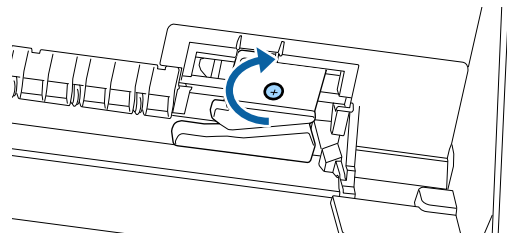

 **Important:**

Screw the cutter firmly, otherwise the cut position may be slightly shifted or skewed.

9 Insert the base of the cutter replacement cover in the correct place, and push in the top part.

Push until you hear it click into place.

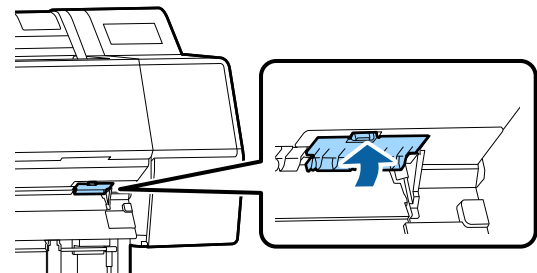

10 After replacing the cutter, press the OK button.

The cutter will return to its original position.

Cutter replacement is complete when the screen on the control panel returns to the screen displayed before you started replacement.

Maintenance

Cleaning the Printer

To keep your printer in optimum operating condition, clean it regularly (about once a month).

Cleaning the outside

- 1 Remove any paper from the printer.
- 2 Make sure the printer is turned off and the screen has turned off, and then unplug the power cable from the outlet.
- 3 Use a soft, clean cloth to carefully remove any dust or dirt.

To prevent dust from accumulating, be sure to clean the following areas on the back and sides. (In the following image, the optional Adobe PostScript 3 expansion unit is installed.)

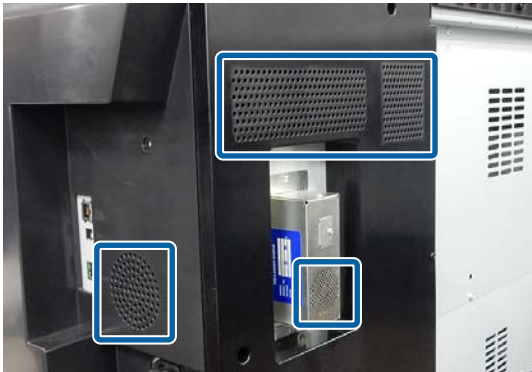

If the printer is particularly dirty, dampen the cloth with water containing a small amount of neutral detergent, and then firmly wring the cloth dry before using it to wipe the printer's surface. Next, use a dry cloth to wipe away any remaining moisture.

! Important:

Never use benzene, thinners, or alcohol to clean the printer. They could cause discoloration and deformities.

Cleaning the inside

Clean the pressure rollers if prints are smudged or soiled.

Ink and particles of paper adhering to the platen should be removed, as they may otherwise soil the paper.

! Important:

Failure to remove dust and particles of paper from the platen could result in clogged nozzles or damage to the print head.

Cleaning the roller

Follow the steps below to clean the roller by feeding plain paper.

- 1 Turn on the printer, and load it with widest available roll paper.
[“Loading and Removing the Roll Paper” on page 30](#)
- 2 Touch **⌘** - **Forward**.
Paper is fed while **Forward** is pressed. If the paper is not soiled, cleaning is complete.
- 3 Cut the paper after cleaning is done.
Touch **⌘** - **Cut** to cut the paper.

Cleaning Inside the Printer

- 1 Make sure the printer is turned off and the screen has turned off, and then unplug the power cable from the outlet.
- 2 Leave the printer for a minute.
- 3 Open the front cover and use a soft, clean cloth to carefully clean away any dust or dirt inside the printer.

Thoroughly wipe the area shown in blue in the illustration below. To avoid spreading the dirt, wipe from the top to the bottom. If the printer is particularly dirty, dampen the cloth with water containing a small amount of neutral detergent, and then firmly wring the cloth dry before using it to wipe the printer's surface. Then, dry off the inside of the printer with a dry, soft cloth.

Maintenance

! **Important:**

When cleaning, do not touch the rollers, the pads for borderless printing, or the ink tubes indicated in gray in the following illustration. Doing so may cause a malfunction or soiled prints.

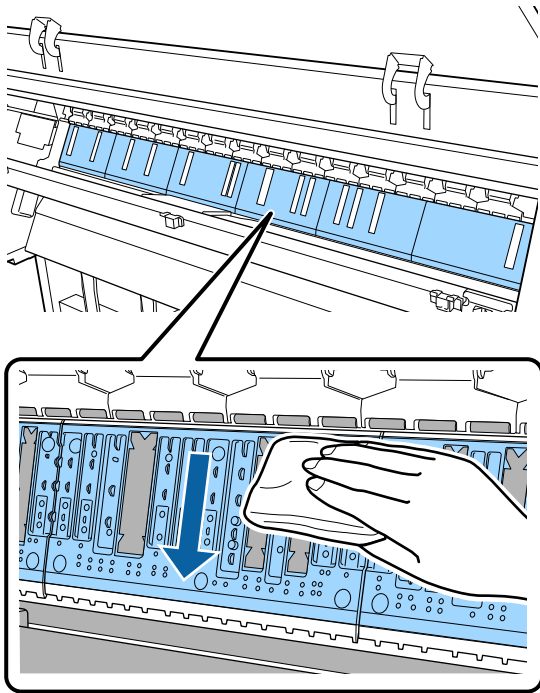

- 4** If any paper particles (that looks like white powder) accumulates on the platen, use something like a cocktail stick to push it in.

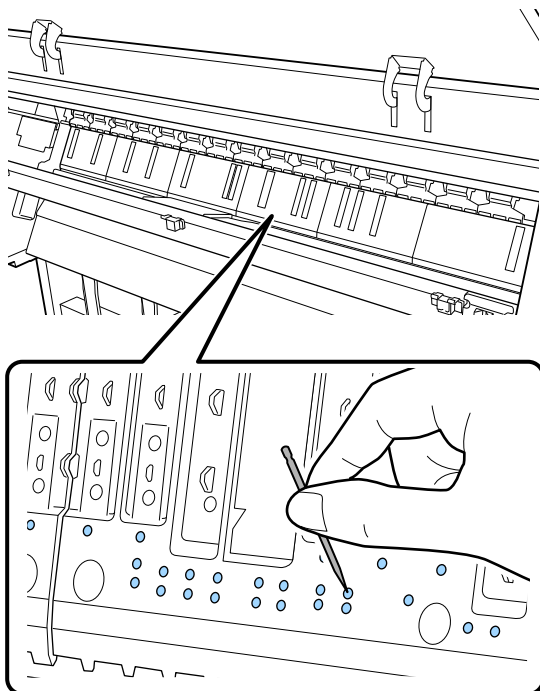

- 5** Use a commercially available cotton swab to wipe off the paper particles and dust from the inner edges of the pads for borderless printing as shown below.

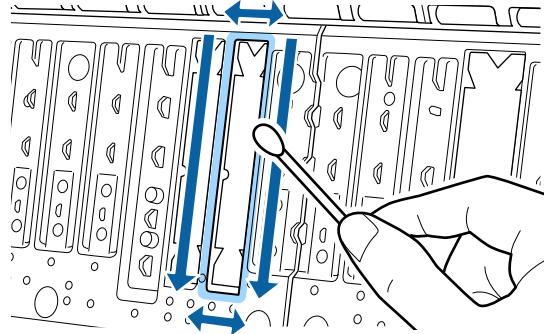

! **Important:**



Do not rub too strongly on the pads for borderless printing. Doing so could cause the pads for borderless printing to come off or lift up causing a malfunction or a paper jam to occur.

- 6** After cleaning, close the front cover.

Problem Solver

What to do When a Message is Displayed

If the printer displays one of the messages shown below, refer to the solution listed and take the necessary steps.



Messages	What to do
<p>Change paper settings Paper setting in the printer driver is different from paper information registered in the printer. Change paper setting from the application or the driver. For details, see your documentation.</p>	<p>To change paper information that was registered using Epson Media Installer, load the paper and then use the control panel.</p> <p>You can also use Epson Media Installer to change paper information for paper that has not been loaded.</p> <p>However, you may not be able to change the paper information depending on the version of Epson Media Installer you are using.</p>
<p>TCP/IP configuration failed The combination of the IP address and the subnet mask is invalid. See your documentation for more details.</p>	<p>Enter the correct values for the IP address and the default gateway. Check with your network administrator if you do not know the correct values.</p>
<p>SpectroProofer error NN The SpectroProofer is not working correctly. See the manual for more details. (where NN is the error number)</p>	<p>The solution depends on the error number. See the following table.</p> <p> "SpectroProofer Error" on page 140</p>
<p>Paper Meander Error Roll paper is meandering. Continue printing with the current roll paper?</p>	<p>The following outlines some of the causes for paper being fed askew.</p> <ul style="list-style-type: none"> <input type="checkbox"/> The roll paper may not have been loaded correctly. Reload the roll paper so that there are no gaps between the roll paper and the roll paper adapters.  "Loading and Removing the Roll Paper" on page 30 <input type="checkbox"/> Paper meander errors occur when using roll paper with uneven left and right edges, curled paper, or roll paper that has become slack. Use paper that has been stored correctly. If you are using roll paper that has become slack, cut off the slack part.  "Notes on handling paper" on page 15

Problem Solver

SpectroProofer Error

If SpectroProofer Error is displayed, see the two numbers at the end of the error number for the solution. See the manual supplied with the mounter for more information on removing, cleaning, and installing, the mounter.

If this message appears on the LCD panel again, contact your dealer or Epson Support.

Error Number	What to do
01	The mounter is not installed correctly. Turn off the printer, remove the mounter, and then install it again.
13, 15	<p>Check the following points.</p> <ul style="list-style-type: none"> <input type="checkbox"/> Is there an error in the backing? Remove the mounter and check the backing condition. If it is not installed correctly, install it again. Remove any packing material or foreign substances between the media holding plates and the backing. <input type="checkbox"/> Are there any errors in the carriage moving area? Remove the mounter and check the base and the interior. Remove any packing material or foreign substances. <input type="checkbox"/> Are there any errors in the calibration tile holder? Remove the mounter and check the status of the calibration tile holder. If it is not installed correctly, install it again. <input type="checkbox"/> Are you using paper that does not meet the required specifications? Do not use paper that is not supported by the mounter.  "Supported Media" on page 168 <input type="checkbox"/> Is the printer being used in an environment that does not meet the required specifications? Make sure you use the printer, mounter, and paper within the required specifications. See the manual supplied with the accessories for more information on the recommended environmental conditions for the mounter and paper. Recommended environment for the printer  "Specifications Table" on page 188
80	<p>Check the following points.</p> <ul style="list-style-type: none"> <input type="checkbox"/> Do the numbers on the ILS30EP and the calibration tile label match? Remove the mounter and check the ILS30EP and the label of the calibration tile. If you have multiple ILS30EP, make sure you install the one that matches the number on the calibration tile. <input type="checkbox"/> Is the lens of the ILS30EP or the calibration tile soiled? See the manual supplied with the mounter to clean the parts.
For numbers other than the above	<p>Make a note of the number displayed and contact customer support services for assistance. If customer support for your area is not listed below, contact the dealer where you purchased your product.</p> <p> See "Where To Get Help" on page 190</p>

Problem Solver

When an Error Message and Error Code are Displayed

Error messages	What to do
<p>A printer part needs to be replaced. Contact Epson Support. For details, see your documentation.</p> <p>XXXXXXXX (Where XXXXXXXX is a 6-digit or 8-digit alphanumeric code.)</p>	<p>A part used in the printer is nearing the end of its service life.</p> <p>Contact your dealer or Epson Support and tell them the maintenance request code.</p> <p>This cannot be cleared until the part is replaced. A printer error will occur if you continue to use the printer.</p>
<p>Printer error. Turn the power off and on again. If the problem persists, contact Epson Support.</p> <p>XXXXXXXX (Where XXXXXXXX is a 6-digit or 8-digit alphanumeric code.)</p>	<p>An error message is displayed in the following situations.</p> <ul style="list-style-type: none"> <input type="checkbox"/> The power cable is not connected securely <input type="checkbox"/> An error that cannot be cleared occurs <p>When a printer error has occurred, the printer automatically stops printing. Turn off the printer, disconnect the power cable from the outlet and from the AC inlet on the printer, and then reconnect. Repeat this several times if the error continues to occur.</p> <p>If the same call for service is displayed on the LCD panel, contact your dealer or EpsonSupport for assistance. Tell them the call for service code is "XXXXXXXX".</p>

Troubleshooting

You cannot print (because the printer does not work)

The printer does not turn on.

■ **Is the power cable plugged into the electrical outlet or the printer?**

Make sure the power cable is securely plugged into the printer.

■ **Is there a problem with the power outlet?**

Make sure your outlet works by connecting the power cable for another electric product.

The printer turns off automatically.

■ **Is Power Off Timer enabled?**

To prevent the printer turning off automatically, select **Off**.

 ["General Settings" on page 116](#)

The printer driver is not installed properly (Windows).

■ **Is the icon for this printer displayed in the Devices and Printers/Printer/Printers and Faxes folder?**

- Yes
The printer driver is installed. See "The printer is not connected correctly to the computer" on the next page.
- No
The printer driver is not installed. Install the printer driver.

■ **Does the printer port setting match the printer connection port?**

Check the printer port.

Click the **Port** tab in the printer Properties dialog and check the option selected for **Print to following port(s)**.

- USB: **USBxxx** (x stands for the port number) for the USB connection
- Network: The correct IP address for the network connection

If it is not indicated, the printer driver is not installed correctly. Delete and reinstall the printer driver.

 ["Uninstalling Software" on page 28](#)

The printer driver is not installed properly (Mac).

■ **Is the printer added to the printer list?**

Click the Apple menu - **System Preferences** - **Printers & Scanners** (or **Print & Fax**).

If the printer name is not displayed, add the printer.

The printer is not communicating with the computer.

■ **Is the cable plugged in properly?**

Confirm that the interface cable is securely connected to both the printer port and the computer. Also, make sure the cable is not broken nor bent. If you have a spare cable, try connecting with the spare cable.

■ **Does the interface cable specification match the specifications for the computer?**

Make sure the interface cable specifications match the specifications for the printer and the computer.

 ["System Requirements" on page 185](#)

Problem Solver

■ When using a USB hub, is it being used correctly?

In the USB specification, daisy-chains of up to five USB hubs are possible. However, we recommend that you connect the printer to the first hub connected directly to the computer. Depending on the hub you are using, the operation of the printer may become unstable. If this should occur, plug the USB cable directly into your computer's USB port.

■ Is the USB hub recognized correctly?

Make sure the USB hub is recognized correctly on the computer. If the computer correctly detects the USB hub, disconnect all USB hubs from the computer and connect the printer directly to the computer USB port. Ask the USB hub manufacturer about USB hub operation.

You cannot print under the network environment.

■ Are the network settings correct?

Ask your network administrator for the network settings.

■ Connect the printer directly to the computer using a USB cable, and then try to print.

If you are able to print via USB, there is a problem with network settings. Ask your system administrator, or refer to the manual for your network system. If you cannot print via USB, see the appropriate section in this User's Guide.

The printer has an error.

■ View the message displayed in the control panel.

 ["Control panel" on page 11](#)

 ["What to do When a Message is Displayed" on page 139](#)

The printer stops printing.

■ Is the status of print queue Pause? (Windows)

If you stop printing or the printer stops printing because of an error, the print queue enters a **Pause** status. You cannot print in this status.

Double-click the printer icon in the **Devices and Printers, Printers**, or **Printers and Faxes** folder; if printing is paused, open the **Printer** menu and clear the **Pause** check box.

■ Does the current printer status show Paused? (Mac)

Open the status dialog for your printer and check whether printing is paused.

(1) Select **System Preferences > Printers & Scanners** (or **Print & Fax**) > **Open Print Queue**> from the **Apple** menu.

(2) Double-click the icon for any printer that is **Paused**.

(3) Click **Resume Printer**.

Problem Solver

Your problem is not listed here.

■ Decide whether the trouble is caused by the printer driver or the application. (Windows)

Perform a test print from the printer driver so that you can check that the connection between the printer and computer is correct and the printer driver settings are correct.

- (1) Make sure that the printer is turned on and in ready status, and load A4 or larger paper.
- (2) Open the **Devices and Printers, Printers, or Printers and Faxes** folder.
- (3) Right-click the target printer icon, and select **Properties**.
- (4) In the Properties dialog, select the **General** tab and click **Print Test Page**.

After a while the printer starts to print a test page.

- If the test page is printed correctly, the connection between the printer and computer is correct. Go to the next section.
- If the test page is not printed correctly, check the items above again.
[🔗 "You cannot print \(because the printer does not work\)" on page 142](#)

The "Driver Version" shown on the test page is the version number of the Windows internal driver. This differs from the Epson printer driver version that you installed.

The printer sounds like it is printing, but nothing prints

The print head moves, but nothing prints.

■ Confirm the printer operation.

Print a nozzle check pattern. Because a nozzle check pattern can be printed without connecting to a computer, you can check the operations and print status for the printer.

[🔗 "Print Head Nozzle Check" on page 125](#)

Check the next section if the nozzle check pattern is not printed correctly.

■ Is the message **Motor self adjustment running, displayed on the control panel's screen?**

The printer adjusts the internal motor. Wait for a while without turning off the printer.

The nozzle check pattern is not printed correctly.

■ Perform head cleaning.

The nozzles may be clogged. Print a nozzle check pattern again after performing head cleaning.

[🔗 "Cleaning the print head" on page 127](#)

■ Has the printer been left unused for a long time?

If the printer has not been used for a long time, the nozzles may have dried up and have been clogged.

The prints are not what you expected

Print quality is poor, uneven, too light, or too dark.

■ Are the print head nozzles clogged?

If the nozzles are clogged, specific nozzles do not fire ink and the print quality declines. Print a nozzle check pattern.

[🔗 "Print Head Nozzle Check" on page 125](#)

■ Has Print Head Alignment been performed?

With bidirectional printing, the print head prints while moving left and right. If the print head is misaligned, ruled lines may be misaligned accordingly. If vertical ruled lines are misaligned during bidirectional printing, perform Print Head Alignment.

[🔗 "Print Head Alignment" on page 129](#)

Problem Solver

■ Are you using a genuine Epson ink cartridge?

This printer is developed for use with Epson ink cartridges. If you use non-Epson ink cartridges, printouts may be faint, or the color of the printed image may be changed because the remaining ink level is not correctly detected. Be sure to use the correct ink cartridge.

■ Are you using an old ink cartridge?

The print quality declines when an old ink cartridge is used. Replace the old ink cartridge with a new one. We recommend using all the ink in the cartridge before the expiry date printed on the package (within six months of installation).

■ Have the ink cartridges been shaken?

The ink cartridges for this printer contain pigment inks. Shake the cartridges thoroughly before installing them in the printer.

 ["Replacing Ink Cartridges" on page 133](#)

■ Are the Media Type settings correct?

Print quality can be affected if the media settings in the printer driver/on the printer and the actual paper do not match. Be sure to match the media type setting with the paper that is loaded in the printer.

■ Did you select a low quality mode (such as Speed) as the Print Quality?

If the options selected for **Print Quality** > **Quality Options** place priority on speed, quality will be sacrificed for print speed, potentially causing print quality to decline. To improve print quality, select **Resolution** options that give priority to quality.

■ Is color management enabled?

Enable color management.

 ["Color Management Printing" on page 104](#)

■ Have you compared the printing result with the image on the display monitor?

Since monitors and printers produce colors differently, printed colors will not always match on-screen colors perfectly.

■ Did you open the printer cover while printing?

If the printer cover is opened while printing, the print head stops suddenly causing unevenness in the color. Do not open the printer cover while printing.

■ Is Ink is low. displayed in the control panel?

The print quality may decline when the ink is low. We recommend replacing the ink cartridge with a new one. If there is a difference in color after replacing the ink cartridge, try performing head cleaning a few times.

■ Are you printing at High Speed on commercially available paper?

If you have selected Custom Paper from **Paper Type** and the colors are uneven in your printouts, try the following.

- If you have not registered settings for the commercially available paper
See the following to register the settings.
 ["Before Printing on Commercially Available Paper" on page 180](#)
- If you have registered settings for the commercially available paper
Perform uni-directional printing. Follow the steps below to clear the checkbox for **High Speed** in the printer driver.
Windows: On the Main screen, select **Quality Options** from **Print Quality**.
Mac: Select **Print Settings** from the list, and then select the **Advanced Color Settings** tab.

The color is not exactly the same as another printer.

■ Colors vary depending on the printer type due to each printer's characteristics.

Because inks, printer drivers, and printer profiles are developed for each printer model, the colors printed by different printer models are not exactly the same.

You can achieve similar colors with the same color adjustment method or the same gamma setting by using the printer driver.

 ["Color Management Printing" on page 104](#)

To match the color precisely, use the color measurement device to perform color management.

Problem Solver

I am worried about different and/or uneven coloring the print quality at the leading edge of the paper.

- **Printing quality is dependent on multiple different factors as quality of paper and the printing environment. The margin at the leading edge of the paper can be small or colors may be uneven or different.**

Print a larger margin at the leading edge of the paper.

 ["Paper Setting" on page 111](#)

- **In Quality Options from the printer driver, set Optimize Edge Quality to Add Top Margin or Optimize Media Edge Print Quality.**

Add Top Margin prints everything in dual head mode, so it prints at the same print speed as normal, but the leading edge margin is larger than normal.

Since **Optimize Media Edge Print Quality** prints everything in single head mode, the print speed is slower than normal.

The print is not positioned properly on the media.

- **Have you specified the print area?**

Check the print area in the settings of the application and the printer.

- **Is the correct option selected for Page Size?**

If the option selected for **Page Size** or **Paper Size** in the printer driver does not match the paper loaded in the printer, the print may not be in the correct position or some of the data may be printed off the paper. In this case, check the print settings.

- **Is the paper skewed?**

If **Off** is selected for **Detect Paper Meandering** in the Printer Settings menu, printing will continue even if the paper is skewed, resulting in data being printed off the paper. Select **ON** for **Detect Paper Meandering** in the Printer Settings menu.

 ["Paper Setting" on page 111](#)

- **Does the print data fit within the paper width?**

Although under normal circumstances printing stops if the print image is wider than the paper, the printer may print outside the bounds of the paper when **Off** is selected for **Paper Size Check** in the Printer Settings menu. Change the setting to **ON**.

 ["Paper Setting" on page 111](#)

- **Are the settings for Top Margin/Bottom Margin too short?**

If the values set for **Top Margin/Bottom Margin** in the Paper menu are wider than the margins set in the application, priority will be given to the values selected for **Top Margin/Bottom Margin**. For example, if 15 mm is selected for the left and right margins in the printer's Paper menu and the document fills the page, the 15 mm at the left and right sides of the page will not be printed.

 ["Printable area" on page 58](#)

- **Are you using a RIP from another company?**

When using a RIP from another company, the Paper Feed Adjust value set in the RIP and in the Control panel menu are both applied, which may cause a shift in the printing position.

When **System Administration - Paper Feed Adjustment Mode - RIP Priority** in the printer's General Settings menu is set to **On**, RIP information is given priority for Paper Feed Adjust. After making this setting, readjusting the **Paper Feed Adjust** value of the RIP may improve misalignments in the printing position.

 ["General Settings" on page 116](#)

- **Are you printing multiple pages?**

If image quality declines when printing multiple pages, make the following two settings on the Control panel.

- From the Paper Setting menu, select **Roll Paper - Advanced Paper Settings - Paper Feed Amount Adjustment - Quality First**
- From the General Settings menu, select **Printer Settings - Paper Source Settings - Roll Paper Setup - Cut Settings - Quick Cut - Off**

Printing speed will now be slower than usual due to the Paper Feed Amount Adjustment operations between pages.

Problem Solver

Vertical ruled lines are misaligned.

■ Is the print head misaligned? (in bidirectional printing)

With bidirectional printing, the print head prints while moving left and right. If the print head is misaligned, ruled lines may be misaligned accordingly. If vertical ruled lines are misaligned with bidirectional printing, perform Print Head Alignment.

 ["Print Head Alignment" on page 129](#)

The printed surface is scuffed or soiled.

■ Is the paper too thick or too thin?

Check that the paper specifications are compatible with this printer.

 ["Supported Media" on page 168](#)

For information about the media types and appropriate settings for printing on paper from other manufacturers or when using RIP software, see the documentation supplied with the paper, or contact the dealer of the paper or the manufacturer of the RIP.

■ Is the paper creased or folded?

Do not use old paper or paper with folds in it. Always use new paper.

■ Is the paper wavy or warped?

If the paper becomes wavy or warped due to changes in temperature or humidity, the paper may be scuffed.

Check the following points.

- Insert the paper just before printing.
- Do not use wavy or warped paper. For roll paper, cut off any parts that are wavy or warped, and then load the paper again. For cut sheets, use new paper.

■ Is the print head scuffing the printed surface?

If the surface of the paper is scuffed, set **Custom Paper Setting** from **General Settings** or **Platen Gap** from **Paper Setting** to widen the gap. If print results still do not improve, try changing **Paper Eject Roller** to **Use** in **Custom Paper Setting**. However, when using glossy paper, setting **Paper Eject Roller** to **Use** may damage the printable surface.

 ["Paper Setting" on page 111](#)

 ["General Settings" on page 116](#)

■ Is the print head scuffing the edge of the paper?

In the Paper menu, set **Top 45 mm/Bottom 15 mm** as the **Roll Paper Setup - Top Margin/Bottom Margin** option.

 ["Paper Setting" on page 111](#)

■ Is the print head scuffing the trailing edge of the paper?

Depending on the paper itself as well as the environment during printing, storage conditions, and the content of the print data, the trailing edge may be scuffed when printing.

Create data with a wider bottom margin.

If the problem continues to occur, select **Optimize Edge Quality** in the printer driver before printing.

■ Is the print head scuffing the left or right edges of the paper?

Depending on the paper itself as well as the environment during printing, storage conditions, and the content of the print data, the left or right edges may be scuffed when printing.

Create data with a wider left or right margin. If the problem continues to occur, rotate the data 90 degrees in the printer driver or your software, and then print.

■ When printing multiple pages, is Auto Cut - Never Cut set?

If you print continuously without cutting the paper for each page, the pages may rub together causing scuffing to occur. Set **Margin Between Pages to 65 mm** in **Custom Paper Setting**.

 ["General Settings" on page 116](#)

Problem Solver

■ **Does the interior of the printer need cleaning?**

The rollers may need cleaning. Clean the rollers by feeding and ejecting paper.

🔗 "Cleaning the inside" on page 137

■ **Try cleaning the area around the print head.**

If the printing surface is dirty even after taking the measures described before this item, see the following to clean around the print head, caps, and wipers.

🔗 "Cleaning around the print head and caps" on page 148

■ **Widen the bottom margin**

Depending on the paper usage, storage conditions, and the content of the print data, the bottom edge may be scuffed when printing. In this situation it is best to create your data with a wider bottom margin.

■ **Does the interior of the printer need cleaning?**

The rollers may need cleaning. Clean the rollers by feeding and ejecting paper.

🔗 "Cleaning the inside" on page 137

■ **Try cleaning around the print head and the caps.**

If the printing surface is dirty even after taking the measures described before this item, see the following to clean around the print head, caps, and wipers.

🔗 "Cleaning around the print head and caps" on page 148

Cleaning around the print head and caps

If print head clogging cannot be cleared using automatic cleaning, clean the print head and the area around the caps.

! Important:

- ❑ Never touch any parts or circuit boards other than those that need to be cleaned. Doing so may cause the printer to malfunction or print quality to decline.
- ❑ Always use new cleaning sticks. Re-using a stick that has already been used may actually apply dirt to the printer.
- ❑ Do not touch the tip of the cleaning stick with your hand. Sebum may stick to it reducing the cleaning effect.
- ❑ Before starting work, touch a metal object to discharge static electricity.
- ❑ Do not wipe the caps with an organic solvent such as alcohol. Doing so may damage the print head.
- ❑ Do not move the print head by hand. Doing so could damage the printer.
- ❑ If paper is loaded in the printer, we recommend removing it before starting work.

Cleaning the Print Head

- 1** Touch **Cleaning the Maintenance Parts** on the printer's control panel.
- 2** Touch **Wiping the Print Head**.
The print head moves to the cleaning position. Wait for the print head to stop moving.
- 3** Remove the rear maintenance cover.

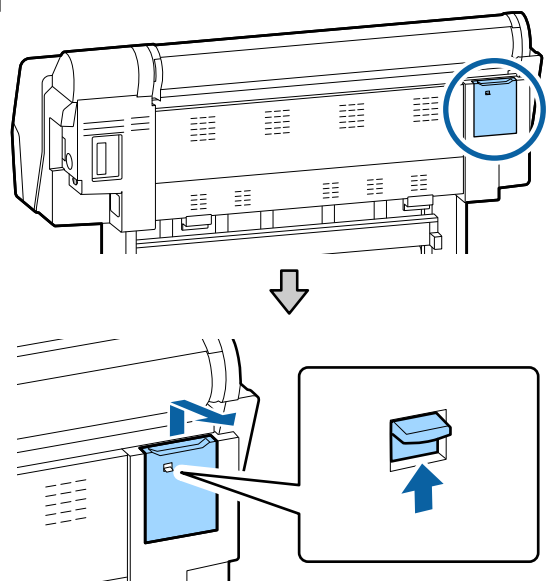

Problem Solver

- 4** Use the cleaning stick to wipe in the directions indicated by the arrows to remove any ink, fluff, or trash.

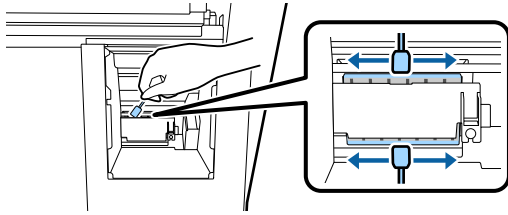

! Important:

Do not touch the parts indicated in the image. Doing so may cause the printer to malfunction or print quality to decline.



- 5** Replace the rear maintenance cover.

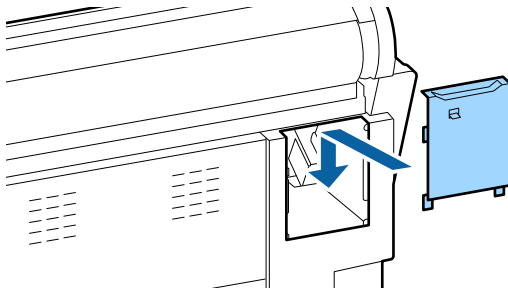

- 6** Press the OK button on the printer's control panel. The print head returns to its original position.

Cleaning Around the Caps

- 1** Touch **Cleaning the Maintenance Parts** on the printer's control panel.
- 2** Touch **Wiping around the Cap.**
The print head moves to the cleaning position.

- 3** Open the ink cover on the right.

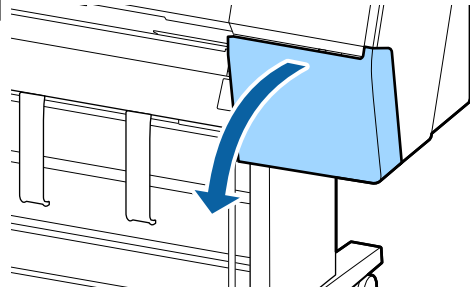

- 4** Remove the front maintenance cover.

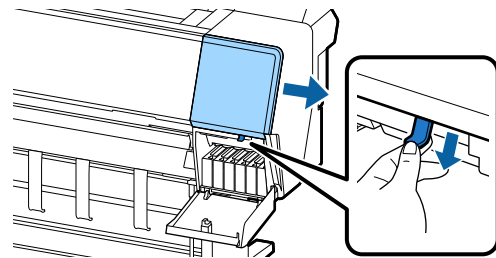

- 5** Open the front cover.

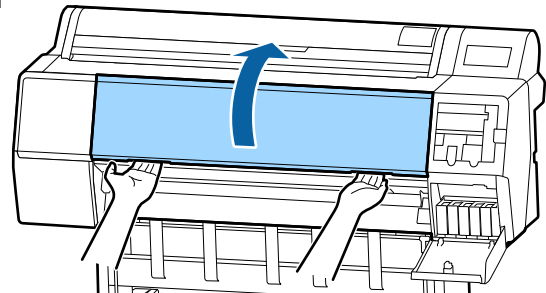

- 6** Use a new cleaning stick to wipe any dirt off the drying caps.

- (1) Hold the cleaning stick so that it is vertical, and wipe the inner areas of all of the drying caps.

! Important:

Do not press too hard on the edges or the area surrounding the caps with tweezers or cleaning sticks. Doing so could cause the parts to become deformed preventing capping from being performed correctly.

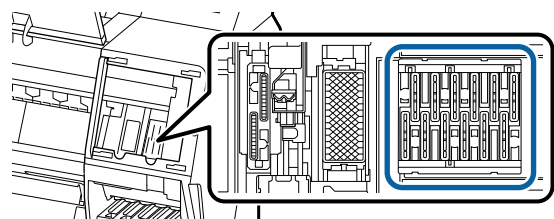

Problem Solver

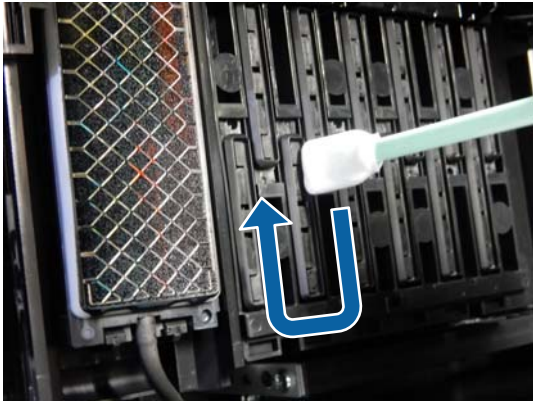

- (2) Hold the cleaning stick so that it is vertical, and wipe the outer areas of all of the drying caps.

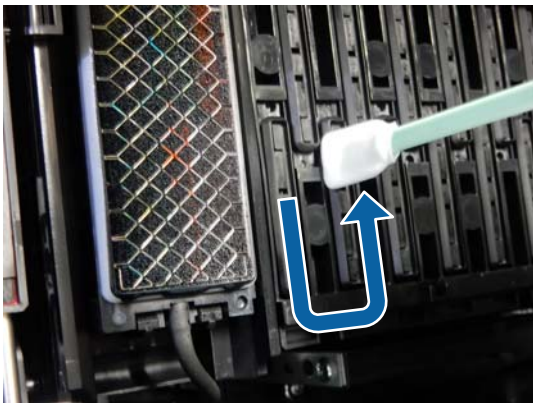

- (3) Flatten the cleaning stick and wipe all of the edges of the drying caps.

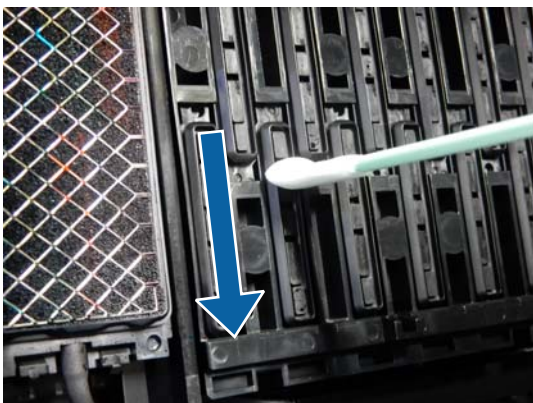

- (4) Hold the cleaning stick so that it is vertical, and wipe all of the guides.

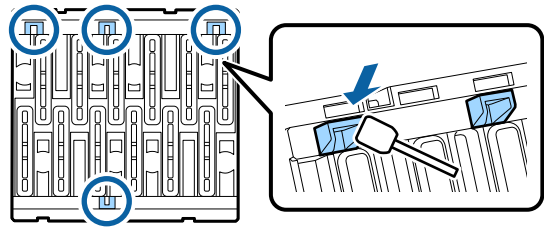

- (5) If there is any fluff or dust in the caps, remove it with the tip of the cleaning stick or with tweezers.

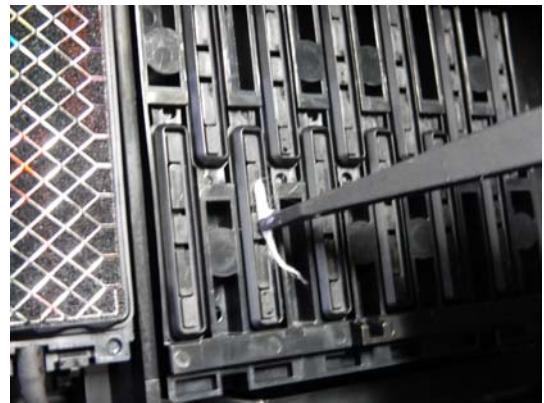

- 7** Use a new cleaning stick to wipe any dirt off the wipers (x 3).

- (1) Wipe any dirt off the outer edges of the wiper (two parts).

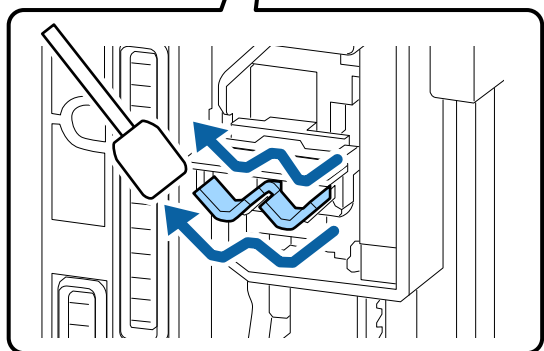
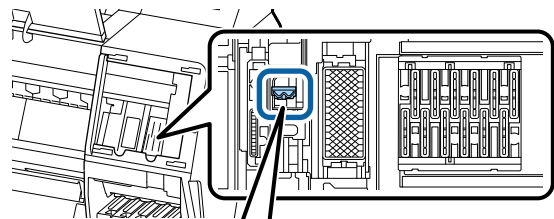

- (2) Wipe any dirt off the outer edges of the wiper (one part).

Problem Solver

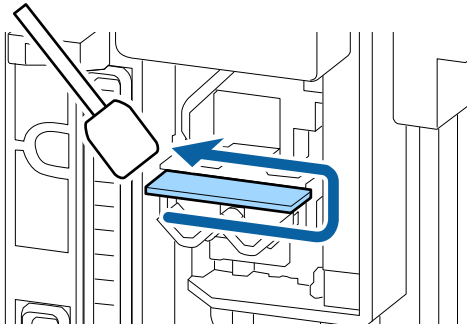

- (3) Wipe any dirt off the upper edge of the wiper (three parts).

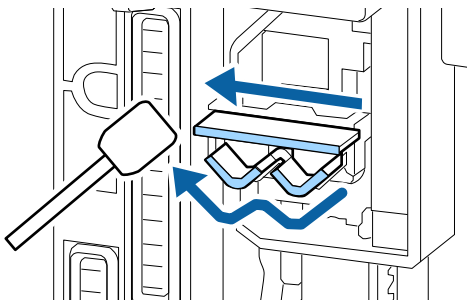

8 Use a new cleaning stick to wipe any dirt off the suction caps.

- (1) Hold the cleaning stick so that it is vertical, and wipe the outer areas of all of the suction caps.

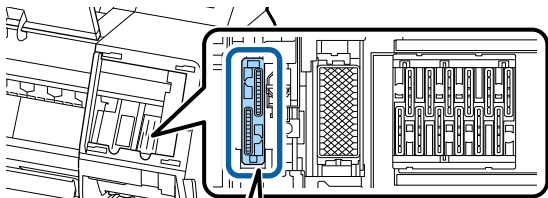

- (2) Flatten the cleaning stick and wipe all of the edges of the suction caps.

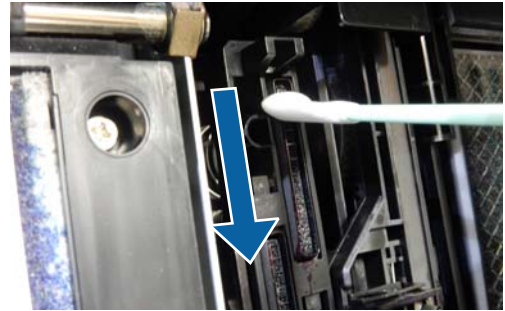

- (3) Hold the cleaning stick so that it is vertical, and wipe all of the guides.

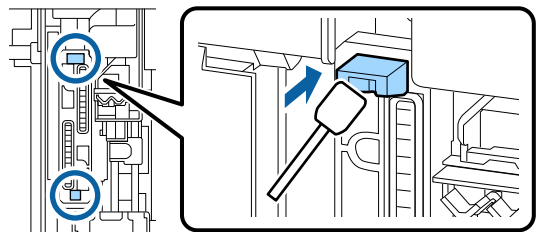

- (4) If there is any fluff or dust in the caps, remove it with the tip of the cleaning stick or with tweezers.

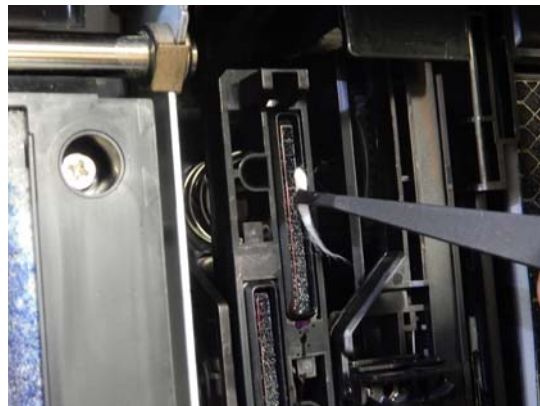

9 Close the front cover.

10 Attach the front maintenance cover, and then close the ink cover on the right.

11 Press the OK button on the printer's control panel. The print head returns to its original position.

Cleaning is performed automatically if the print head is clogged.

Problem Solver

The paper is creased.

■ **Are you using the printer at normal room temperature?**

Epson special media should be used at normal room temperature (temperature: 15 to 25°C, humidity: 40 to 60%). For information about paper such as thin paper from other manufacturers that requires special handling, see the documentation supplied with the paper.

■ **When using non-Epson special media, have you made the paper configuration?**

When using non-Epson special media, configure the paper characteristics (custom paper) before printing.

["Before Printing on Commercially Available Paper" on page 180](#)

Print outs are wrinkled



■ **Dry the paper after printing**

Drying the paper after printing may help to reduce wrinkles in the paper.

Rolling out the paper and stretching it can also improve any wrinkles in the paper.

■ **Lower the ink density used when printing**

The paper may wrinkle when printing using high density ink. Lower the density of the ink in "Paper Configuration" from the driver.

■ **Lower the resolution used when printing**

The paper may wrinkle when printing at a high resolution. Lower the resolution in "Print Quality" from the driver.

The reverse side of the printed paper is soiled.

■ **Select ON for Paper Size Check in the Settings menu.**

Although printing normally stops if the print image is wider than the paper, when **Off** is selected for **Paper Size Check** in the Printer Settings menu, the printer may print outside the bounds of the paper, getting ink on the inside of the printer in the process. This can be prevented by changing the setting to **ON**.

["Paper Setting" on page 111](#)

["Cleaning the inside" on page 137](#)

■ **Is ink dry on the printed surface?**

Depending on the printing density and media type, the ink may take a while to dry. Do not stack the paper until the printed surface is dry.

Also, if you set the **Drying Time per Head Pass** in **Paper Configuration** from the printer driver, you can stop the operation after printing (ejecting and cutting paper) and wait until the ink is dry. See the printer driver help for more details on the Paper Configuration dialog box.

■ **Follow the steps below to clean the platen and the outer edges of the pads for borderless printing, and replace the pads for borderless printing if necessary.**

① **Clean the platen and outer edges of the pads for borderless printing.**

["Cleaning the platen and outer edges of the pads for borderless printing" on page 153](#)



Soiling occurs on the back of the paper again right after cleaning

② **Replace the pads for borderless printing.**

["Replacing the pads for borderless printing" on page 154](#)

Problem Solver

! Important:

Continuing use with paper particles and dust adhered to the platen and the pads for borderless printing may cause a print head failure or nozzle clogging.

Cleaning the platen and outer edges of the pads for borderless printing

- 1** Make sure the printer is turned off and the screen has turned off, and then unplug the power cable from the outlet.
- 2** Leave the printer for a minute.
- 3** Open the front cover.

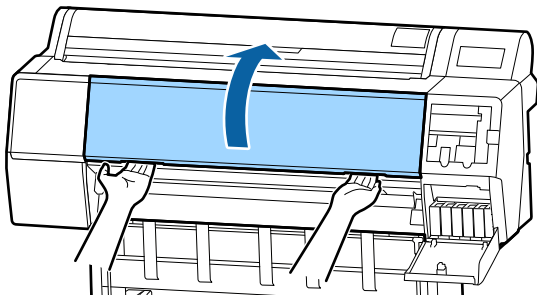

- 4** Clean the platen near the back where soiling occurs. Use a soft cloth to remove any dust or dirt.

Thoroughly wipe the area shown in blue in the illustration below. To avoid spreading the dirt, wipe from the top to the bottom. If the printer is particularly dirty, dampen the cloth with water containing a small amount of neutral detergent, and then firmly wring the cloth dry before using it to wipe the printer's surface. Then, dry off the inside of the printer with a dry, soft cloth.

! Important:

When cleaning, do not touch the rollers, the pads for borderless printing, or the ink tubes indicated in gray in the following illustration. Doing so may cause a malfunction or soiled prints.

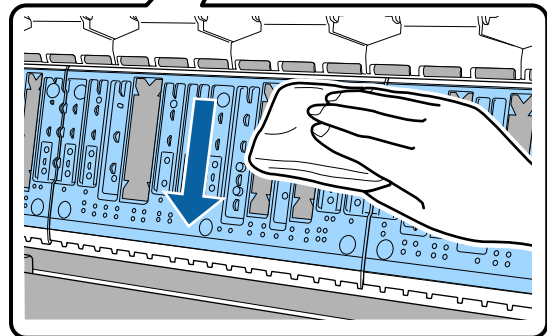
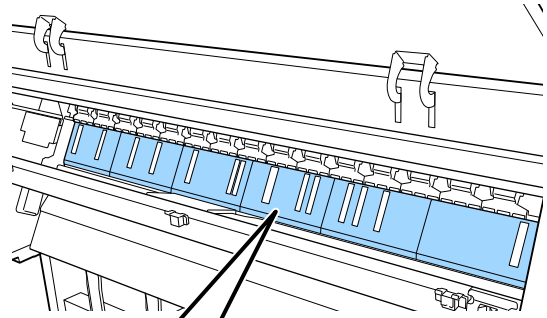

- 5** If any paper particles (resemble white powder) have accumulated in the holes shown in the illustration below, use a pointed object such as a toothpick to push them in.

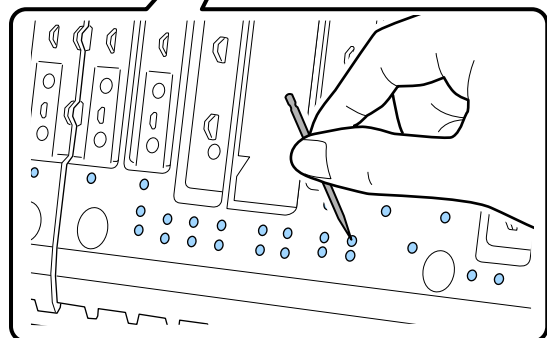
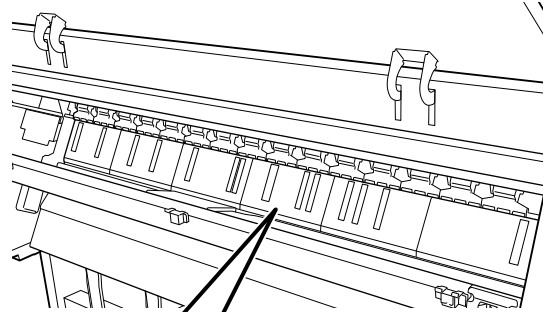

Problem Solver

- 6** Remove paper particles and dust around the outer edges with commercially available cotton swabs as shown below.

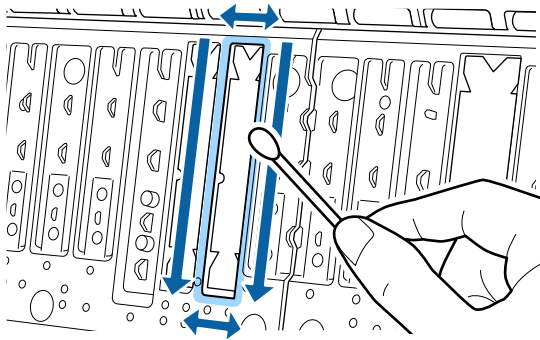

If the back of the paper is soiled immediately after cleaning, replace the pads for borderless printing.

Replacing the pads for borderless printing

Obtain the Borderless Replacement Pad Kit for this printer and then replace the pads for borderless printing.

 [“Options and Consumable Products” on page 163](#)

When replacing the pads for borderless printing, replace only the ones at the places where soiling occurs on the paper back side. There is no need to replace all of the pads for borderless printing.

- 1** Make sure the printer is turned off and the screen has turned off, and then unplug the power cable from the outlet.

- 2** Leave the printer for a minute.

- 3** Open the front cover.

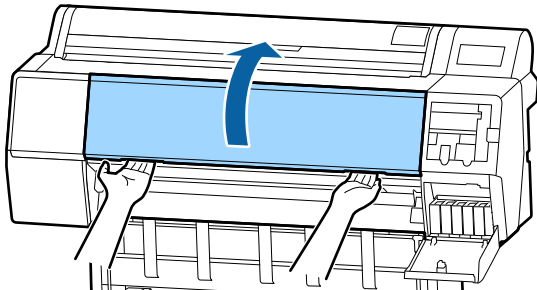

- 4** Prepare the replacement pads for borderless printing.

There are three types of pads for borderless printing. The type of pad depends on where the pads for borderless printing are installed. See the following for the installation positions.

 [“Options and Consumable Products” on page 163](#)

- 5** Use tweezers to pull out the pads for borderless printing that are located at the places where soiling occurs.

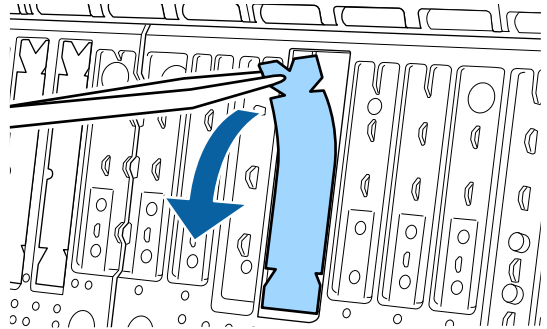

- 6** Use cleaning sticks to wipe off all ink that has accumulated at the following three places.

Bottom

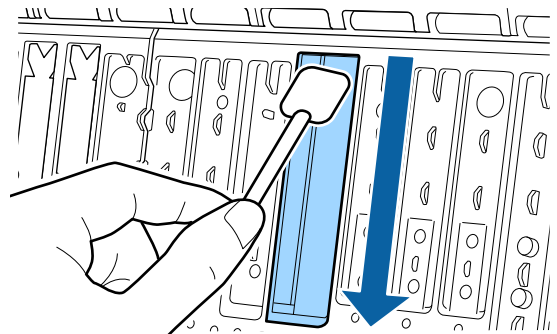

Center groove

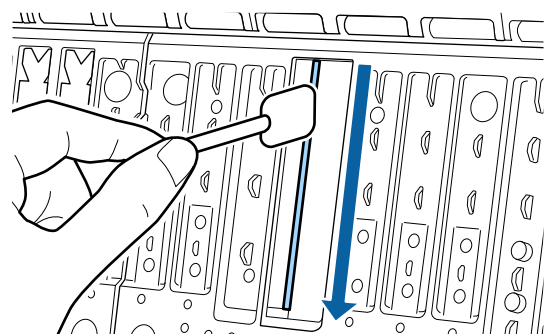

Problem Solver

Sides

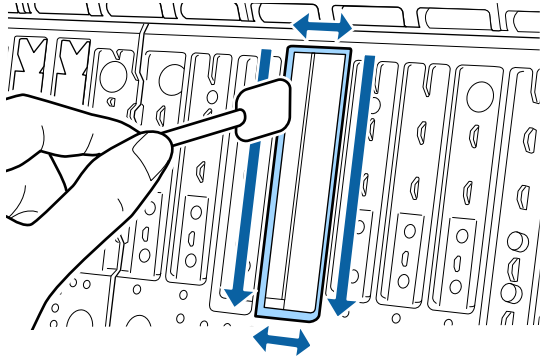

7 Bend a new pad for borderless printing.

The bending method varies depending on the installation position. See the following for the installation positions.

["Options and Consumable Products" on page 163](#)

! Important:

Do not bend the new pads for borderless printing at other than the specified place.

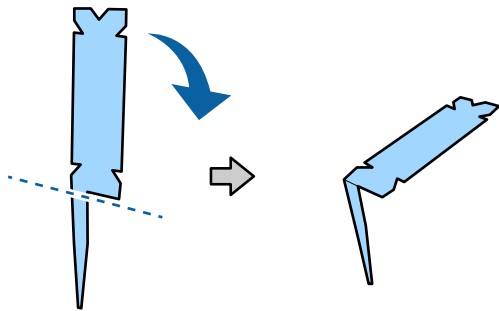

Bend the pad for borderless printing marked with an * in the "Consumables and Options" illustration as shown in the diagram.

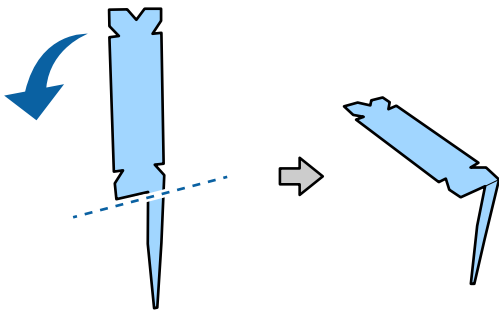

8 Insert the leg of the pad for borderless printing all the way into the hole.

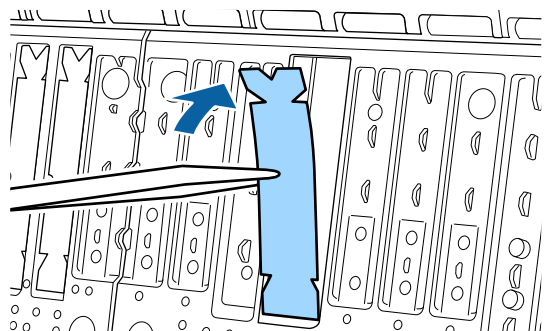
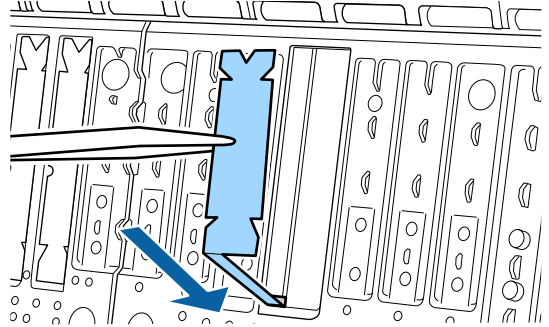

9 Press the pad for borderless printing into the pad section.

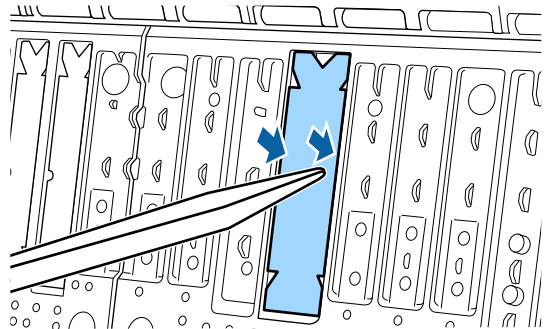

10 Gently press the pad for borderless printing until it is seated flatly in place.

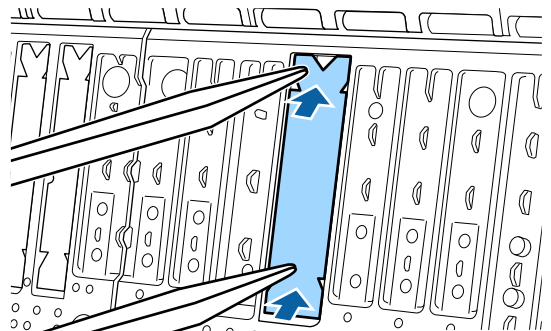

Problem Solver

Important:

Make sure that no portion of the pads for borderless printing is higher than the surrounding surface.

If any portion of the pads is higher than the surrounding surface, it will rub against the print head and may result in printer failure.

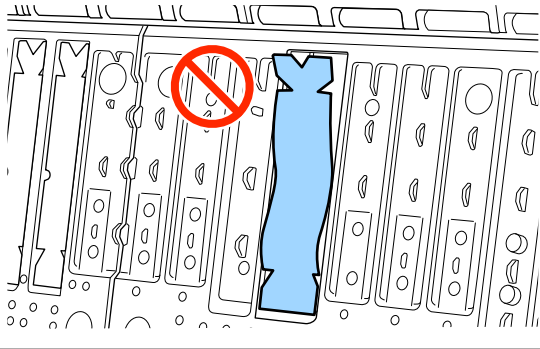

To store any unused new pads for borderless printing, return them into the bag and close the fastener.

Too much ink is fired.

■ **Are the Media Type settings correct?**

Make sure that the printer driver's **Media Type** settings match the paper that you are using. The amount of ink to be fired is controlled according to the media type. If the settings do not match the paper loaded, too much ink may be fired.

■ **Is the Color Density setting correct?**

Lower the density of the ink in the **Paper Configuration** dialog box from the printer driver. The printer may be firing too much ink for some paper. See the printer driver help for more details on the Paper Configuration dialog box.

■ **Are you printing on tracing paper?**

If too much ink is used when printing in **Gray** on tracing paper, you may get better results by choosing a lower print density in the **Paper Configuration** dialog box.

Margins appear in borderless printing.

■ **Are the settings for the print data in the application correct?**

Make sure that the paper settings in the application are correct as well as in the printer driver.

 ["Borderless Printing" on page 81](#)

■ **Are the paper settings correct?**

Make sure that the paper settings of the printer match the paper that you are using.

■ **Have you changed the amount of enlargement?**

Adjust the amount of enlargement for borderless printing. Margins may appear if you set the amount of enlargement to **Mid**.

 ["Borderless Printing" on page 81](#)

■ **Is the paper stored correctly?**

The paper may expand or contract if it is not stored correctly so that margins appear even when borderless is set. See the documentation supplied with the paper for more information on the storage method.

■ **Are you using paper that supports borderless printing?**

Paper that does not support borderless printing may expand or contract while printing so that margins appear even when borderless is set. We recommend using paper that is designed to support borderless printing.

■ **Try adjusting the cutter.**

When there are margins on the top and bottom of the roll paper while performing borderless printing, try performing **Adjust Cut Position**. It may reduce the margins.

 ["Cutting the roll paper" on page 33](#)

Problem Solver

Feeding or ejecting problems

Unable to feed or eject paper.

■ Is the paper loaded in the correct position?

See the following for the correct paper loading positions.

 ["Loading and Removing the Roll Paper" on page 30](#)

 ["Loading and Removing Cut Sheets/Poster Board" on page 37](#)

If the paper is loaded correctly, check the condition of the paper that you are using.

■ Is the paper loaded in the correct direction?

Load cut sheets vertically. If they are not loaded in the correct direction, the paper may not be recognized and an error may occur.

 ["Loading and Removing Cut Sheets/Poster Board" on page 37](#)

■ Is the paper creased or folded?

Do not use old paper or paper with folds in it. Always use new paper.

■ Is the paper damp?

Do not use paper that is damp. Also, Epson special media should be left in the bag until you intend to use it. If it is left out for a long time, the paper curls up and gets damp so that it does not feed properly.

■ Is the paper wavy or warped?

If the paper becomes wavy or warped due to changes in temperature or humidity, the printer may not be able to recognize the paper size correctly.

Check the following points.

- Insert the paper just before printing.
- Do not use wavy or warped paper.
For roll paper, cut off any parts that are wavy or warped, and then load the paper again.
For cut sheets, use new paper.

■ Is the paper too thick or too thin?

Check that the paper specifications are compatible with this printer. For information about the media types and appropriate settings for printing on paper from other manufacturers or when using RIP software, see the documentation supplied with the paper, or contact the dealer of the paper or the manufacturer of the RIP.

■ Are you using the printer at normal room temperature?

Epson special media should be used at normal room temperature (temperature: 15 to 25°C, humidity: 40 to 60%).

■ Is paper jammed in the printer?

Open the printer cover of the printer and check that there are no paper jams or foreign objects in the printer. If paper is jammed, see "Paper jams" below and clear the jammed paper.

■ Is the paper suction too strong?

If you continue to have problems with ejected paper, try lowering the Paper Suction (the amount of suction used to keep the paper on the paper feed path).

 ["Paper Setting" on page 111](#)

■ Are you using paper that curls easily?

When using paper that curls easily, make sure you are in an environment with a room temperature of 23 degrees or higher.

Problem Solver

■ **Is the roll paper installed correctly on the roll paper adapter?**

Feeding will not be performed correctly if the roll paper is not installed correctly on the roll paper adapter.

The roll paper cannot be installed correctly if there are any paper particles sticking to the roll paper adapter. Clean the roll paper adapter if there are any paper particles stuck to it.

Paper particles stuck to adapter



Cleaned adapter



Paper does not collect in the paper basket or is creased or folded when the paper basket is used.

■ **Does the print job require a lot of ink, or is the humidity of the workplace high?**

Depending on the job and the work environment, paper may not collect in the paper basket. Take the following measures as appropriate.

- ❑ Paper does not collect in the paper basket: Use your hands to lightly press the paper into the paper basket as it is ejected from the printer.
- ❑ The paper folds after it has been cut automatically: Select manual cutting and take the paper in both hands after it is cut.
- ❑ The paper creases and does not collect well in the paper basket: Resume printing after closing the paper basket. Before the paper ejected from the printer touches the floor, take it in both hands close to the paper eject guides and continue to lightly support it until printing is complete.

Roll paper jam

To remove jammed paper, follow the steps below:

- 1 Open the roll paper cover, and then cut the paper above the paper insertion slot using a commercially available cutter.

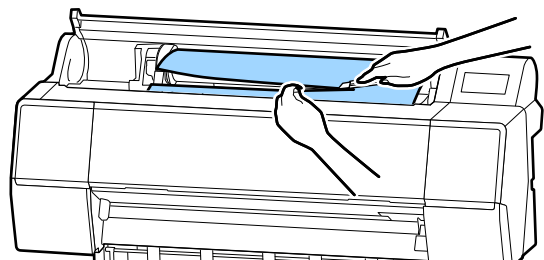

- 2 Rewind the roll paper.

- 3 Open the front cover.

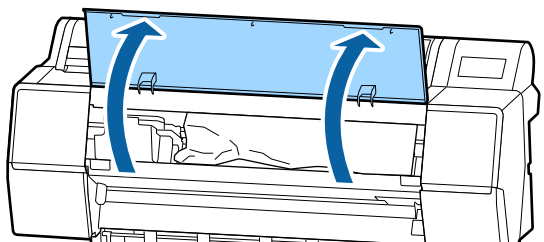

Problem Solver

! Important:

Do not touch the cables around the print head. Failure to observe this precaution could damage the printer.

- 4** Using your hand, slowly move the print head to the side that is not jammed with paper.

! Important:

Other than when you are removing paper jams, do not touch the print head. If you touch the print head with your hand, static electricity may cause a malfunction.

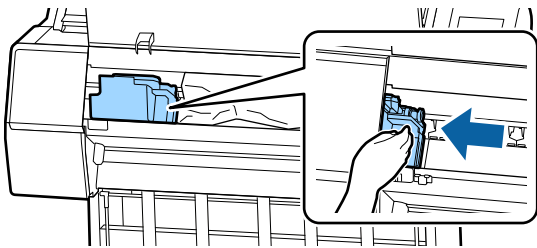

- 5** Remove the jammed paper. Do not touch the rollers, ink absorbing areas, or ink tubes.

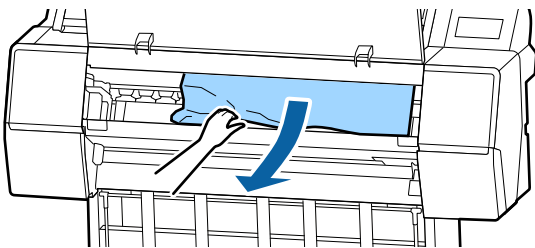
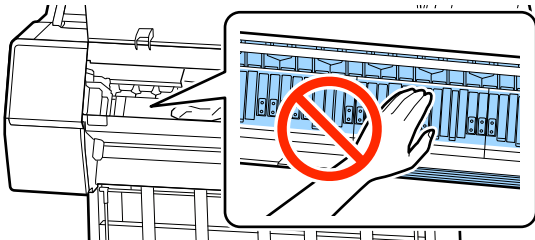

- 6** Close the front cover.
- 7** Turn the printer off and then back on.
- 8** Reload the paper and resume printing.
[“Loading Roll Paper” on page 30](#)

! Important:

Before you reload the roll paper, cut the edge straight horizontally. Cut any wavy or creased sections. If there is a problem at the edge, decreased print quality and paper jams may occur.

Cut sheets jam

To remove jammed paper, follow the steps below:

- 1** Open the front cover.

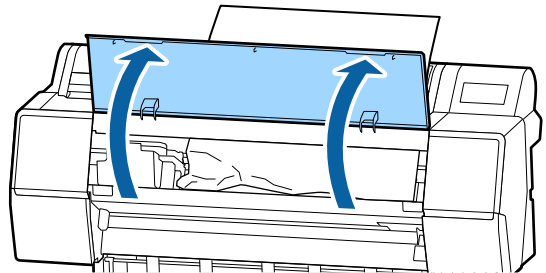

! Important:

Do not touch the cables around the print head. Failure to observe this precaution could damage the printer.

- 2** Using your hand, slowly move the print head to the side that is not jammed with paper.

! Important:

Other than when you are removing paper jams, do not touch the print head. If you touch the print head with your hand, static electricity may cause a malfunction.

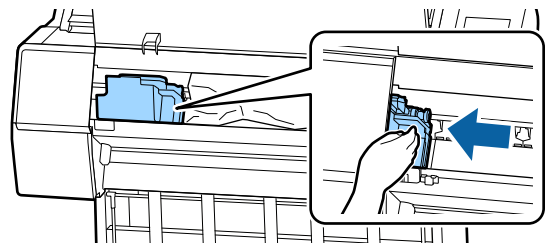

Problem Solver

- 3** Remove the jammed paper.
Do not touch the rollers, ink absorbing areas, or ink tubes.

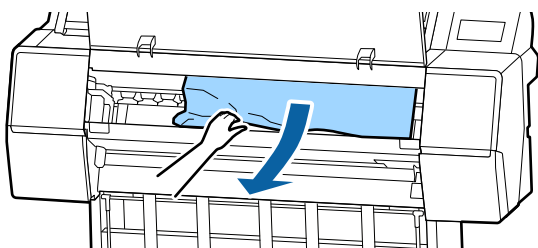

- 4** Close the front cover.
- 5** Turn the printer off and then back on.
- 6** Reload the paper and resume printing.

["Loading and Removing Cut Sheets/Poster Board" on page 37](#)

Others

The control panel display keeps turning off.

■ **Is the printer in sleep mode?**

Sleep mode is exited if a print job is received or the button on the control panel is pressed. The delay can be changed from the General Settings menu.

["General Settings" on page 116](#)

Color ink runs out quickly even when printing in the Black&White mode or when printing black data.

■ **Color ink is consumed during the head cleaning process.**

If all nozzles are selected when you perform **Print Head Cleaning** or **Power Cleaning**, inks of all colors will be used. (This is true even if you are currently printing in black and white.)

["Cleaning the print head" on page 127](#)

The paper is not cut cleanly.

■ **Replace the cutter.**

If the paper is not cut cleanly, replace the cutter.

["Replacing the Cutter" on page 135](#)

A light is visible inside the printer.

■ **This is not a failure.**

The light is a light inside the printer.

The administrator password has been lost

- Should you forget the administrator password, contact your dealer or Epson Support.

Head cleaning is performed automatically

- The printer may automatically perform head cleaning to ensure print quality.

The noise made by the drying fan during color measurement is slightly louder than in previous models.

■ **This is not a failure.**

Depending on the usage environment, the noise made by the drying fan during color measurement may be slightly louder than in previous models.

Problem Solver

When an error occurs during color measurement (when using the SpectroProofer mounter), the colors do not match even after performing color calibration

■ Are the temperature and humidity within the range specified for the printer (during operation) and paper?

If the color measurement chart is printed outside the recommended environmental conditions, the correct color measurement is not acquired. See the manuals supplied with the printer and paper for the recommended environmental conditions.

Recommended environment for the printer
 ["Specifications Table" on page 188](#)

■ Do the RIP or application print settings differ from the actual print conditions?

Printing cannot be performed correctly if the paper type or black ink type differ from the RIP or application settings. Check the paper type loaded in the printer and the black ink type settings are correct.

■ Was the color measurement chart printed with clogged nozzles?

Check that there is no visible banding (horizontal lines at regular intervals) in the color measurement chart. If a color measurement chart is printed with clogged nozzles, the correct color measurement result cannot be acquired. If there are clogged nozzles, perform head cleaning, and then print the color measurement chart again.

 ["Cleaning the print head" on page 127](#)

■ Are there stains or scratches on the color measurement chart, or does ink peel off?

If there are stains or scratches on the color measurement chart, or if ink peels off, the correct color measurement result cannot be acquired. Reprint the color measurement chart.

■ Is the color measurement chart sufficiently dry?

If the ink has not dried sufficiently, the correct color measurement result cannot be acquired. When using commercially available paper, if the drying time is not increased beyond the standard time, ink will not be dried sufficiently. Set a longer drying time in the RIP or application you are using. See the manual supplied with the RIP or application for more information in setting the drying time. See the manual supplied with the paper for more information on the drying condition.

■ Was custom paper information registered?

When performing calibration for commercially available paper, use one of the following methods to register custom paper information.

- Register using Epson Media Installer.
- Register using the printer's control panel.
 ["When there is no paper information on the control panel or in the driver" on page 39](#)

■ Is any external light (direct sunlight) entering the printer when performing color measurement?

If any external light enters the printer, the correct color measurement result cannot be acquired. Prevent external light from entering the printer.

Cannot update the firmware for the printer

■ Are there any jobs in progress or outstanding jobs on the printer?

Wait for the jobs to finish being processed or cancel the jobs.

Printing stops when printing in a VPN (Virtual Private Network) environment

■ Try setting the network setting to 100Base-TX Auto.

You can set this from Settings - General Settings - Network Settings - Quality Options on the control panel.

You can also change network settings in Web Config or Epson Device Admin.

Problem Solver

- **Print using the optional hard disk unit. Store the print data in the hard disk unit before printing.**

Select Print after Transmission Completed or Print Mode - Save only in the printer driver's Hard Disk Unit Settings.

The printer turned off due to a power cut

- **Turn off the printer, and then turn it back on.**

When the printer is not turned off normally, the print head may not be capped correctly. If the print head is left uncapped for a long time, the print quality may decline.

When you turn on the printer, capping is performed automatically after a few minutes.

Also, if the printer is turned off during calibration, data transmission and writing adjustment values may not be performed correctly. When the date is initialized, the adjustment values are also initialized.

Appendix

Options and Consumable Products

The following options and consumable products are available for use with your printer. (As of November, 2019)

For the latest information, see the Epson Web site.

Epson Special Media

 [“Epson Special Media Table” on page 168](#)

Ink cartridges

Epson recommends the use of genuine Epson ink cartridges. Epson cannot guarantee the quality or reliability of non-genuine ink. The use of non-genuine ink may cause damage that is not covered by Epson's warranties, and under certain circumstances, may cause erratic printer behavior.

Information about non-genuine ink levels may not be displayed, and use of non-genuine ink is recorded for possible use in service support.

 [“Replacing Ink Cartridges” on page 133](#)

SC-P9500/SC-P7500

Color Name	Part number	
	700 ml	350ml
Photo Black	T44J1	T44Q1
Cyan	T44J2	T44Q2
Vivid Magenta	T44J3	T44Q3
Yellow	T44J4	T44Q4
Light Cyan	T44J5	T44Q5
Vivid Light Magenta	T44J6	T44Q6
Light Black	T44J7	T44Q7
Matte Black	T44J8	T44Q8
Light Light Black	T44J8	T44Q9
Orange	T44JA	T44QA
Green	T44JB	T44QB
Violet	T44JD	T44QD

Appendix

SC-P9570/SC-P7570

Color Name	Part number		
	700 ml	350 ml	150ml
Photo Black	T44H1	T44P1	T44W1
Cyan	T44H1	T44P2	T44W2
Vivid Magenta	T44H3	T44P3	T44W3
Yellow	T44H4	T44P4	T44W4
Light Cyan	T44H5	T44P5	T44W5
Vivid Light Magenta	T44H6	T44P6	T44W6
Light Black	T44H7	T44P7	T44W7
Matte Black	T44H8	T44P8	T44W8
Light Light Black	T44H9	T44P9	T44W9
Orange	T44HA	T44PA	T44WA
Green	T44HB	T44PB	T44WB
Violet	T44HD	T44PD	T44WD

SC-P9580/SC-P7580

Color Name	Part number	
	700 ml	350 ml
Photo Black	T44L1	T44S1
Cyan	T44L2	T44S2
Vivid Magenta	T44L3	T44S3
Yellow	T44L4	T44S4
Light Cyan	T44L5	T44S5
Vivid Light Magenta	T44L6	T44S6
Light Black	T44L7	T44S7
Matte Black	T44L8	T44S8
Light Light Black	T44L9	T44S9
Orange	T44LA	T44SA
Green	T44LB	T44SB
Violet	T44LD	T44SD

Appendix

Others

Product	Part number	Explanation
Maintenance Box	T6997	Replacement part for when the message Not Enough Space is displayed for the maintenance box. ☞ "Replacing Maintenance Box" on page 134
Auto Cutter Spare Blade	C12C815331	☞ "Replacing the Cutter" on page 135
Roll Media Adapter	SCRPA3	When loading roll paper, these attach to both ends of the paper core. ☞ "Loading and Removing the Roll Paper" on page 30
Borderless Replacement Pad Kit	C13S210102	Absorption pads for borderless printing. ☞ "The reverse side of the printed paper is soiled." on page 152
SpectroProofer Mounter 44" ^{*1}	C12C890521	When the optional color measurement device ILS30EP is installed and attached to the printer, color measurement is automatically performed for printed material. See the manual supplied with the mounter for more information on installing. You need a commercially available software RIP to use the mounter.
SpectroProofer Mounter 24" ^{*2}	C12C890531	
ILS30EP	C12C932021	Color measurement device installed on the mounter. See the manual supplied with the color measurement device for more information on installing on the mounter.
Auto Take-up Reel Unit ^{*1}	C12C815323	Automatically winds printed roll paper around the paper core. See the manual supplied with the Auto Take-up Reel Unit for more information on installing. Use ☞ "Using the Auto Take-up Reel Unit (SC-P9500 Series Only)" on page 48
Hard Disk Unit	C12C934551	☞ "Using the Optional Hard Disk Unit" on page 61
Adobe® PostScript® 3™ Expansion Unit	C12C934571	This unit allows you to use the printer as a PostScript printer. For information on using the unit, see the documentation supplied with the Adobe PostScript 3 Expansion Unit.
Roll Paper Belt	C12C890121	This holder keeps roll paper from unrolling after it is removed from the printer. ☞ "Removing Roll Paper" on page 35
Epson Edge Print	C12C934181	Genuine Epson software RIP.

*1 Only for the SC-P9500 Series.

*2 Available for the SC-P7500 Series.

Appendix

Absorption pad replacement kit (absorption pads for borderless printing)

The pad replacement kit contains three types of borderless printing pad.

The type of pad depends on where the absorption pads for borderless printing are installed.

SC-P9500 Series

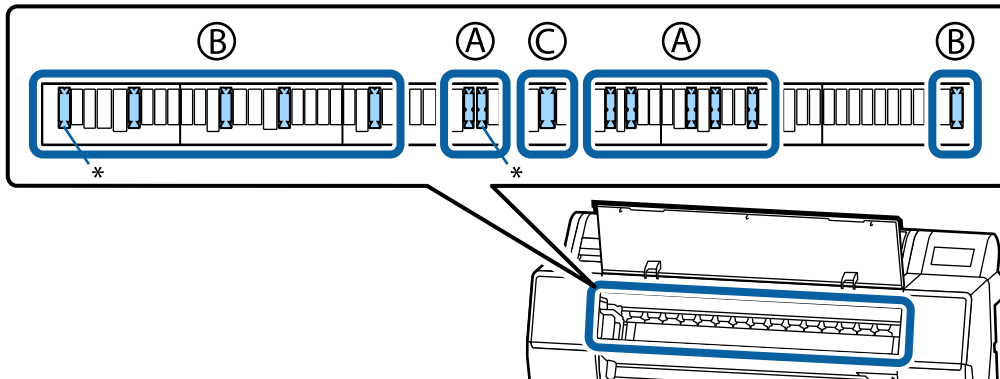

SC-P7500 Series

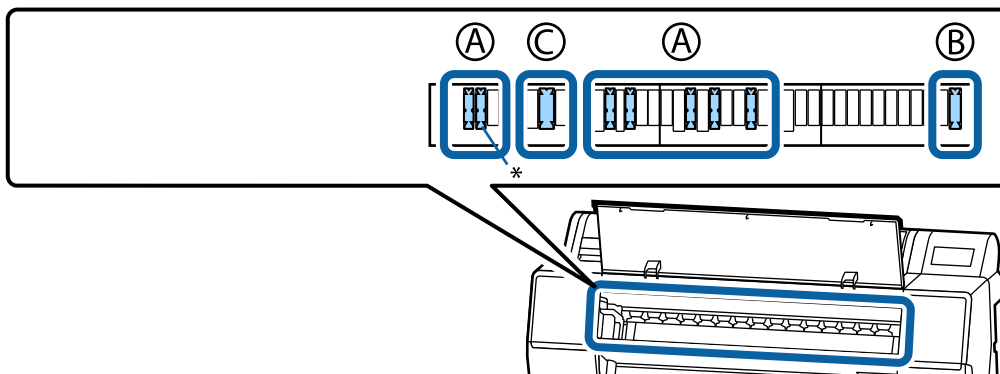

A: Notched type

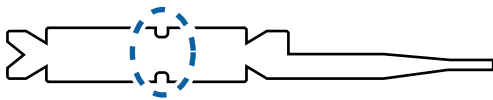

B: Straight type



C: Wide type



See the following for the installation instructions.

Appendix

 "The reverse side of the printed paper is soiled." on page 152

Appendix

Supported Media

We recommend you use the following Epson special media for high-quality printing results.

Note:

For information about the media types and appropriate settings for printing on paper other than Epson special media or when using raster image processing (RIP) software, see the documentation supplied with the paper, or contact the dealer of the paper or the manufacturer of the RIP.

Epson Special Media Table

Roll Paper

Premium Glossy Photo Paper (250)

Paper Thickness	0.27 mm
Roll core size	3 inches
Paper Type (printer driver)	Photo Paper - Premium Glossy Photo Paper (250)
Type of black ink	Photo Black (BK)
ICC profile	EPSON_SC-P9500_7500_PremiumGlossyPhotoPaper250.icc
Paper Width	406 mm/16 inches 610 mm/24 inches 914 mm/36 inches* 1118 mm/44 inches* * SC-P7500 Series is not supported.
Borderless Printing	Available for all paper widths.
Auto Color Measurement Device Mounter	Available for all paper widths.
Auto Take-up Reel Unit	Printed side out and printed side in winding is available for all paper widths.

Premium Semigloss Photo Paper (250)

Paper Thickness	0.27 mm
Roll core size	3 inches
Paper Type (printer driver)	Photo Paper - Premium Semigloss Photo Paper (250)
Type of black ink	Photo Black (BK)
ICC profile	EPSON_SC-P9500_7500_PremiumSemiglossPhotoPaper250.icc

Appendix

Paper Width	406 mm/16 inches 610 mm/24 inches 914 mm/36 inches* 1118 mm/44 inches* * SC-P7500 Series is not supported.
Borderless Printing	Available for all paper widths.
Auto Color Measurement Device Mounter	Available for all paper widths.
Auto Take-up Reel Unit	Printed side out and printed side in winding is available for all paper widths.

Premium Luster Photo Paper (260)

Paper Thickness	0.27 mm
Roll core size	3 inches
Paper Type (printer driver)	Photo Paper - Premium Luster Photo Paper (260)
Type of black ink	Photo Black (BK)
ICC profile	EPSON_SC-P9500_7500_PremiumLusterPhotoPaper260.icc
Paper Width	254 mm/10 inches 300mm 406 mm/16 inches 508 mm/20 inches 610 mm/24 inches 914 mm/36 inches* 1118 mm/44 inches* * SC-P7500 Series is not supported.
Borderless Printing	Paper that is 508 mm/20 inches wide is not supported. Available for other paper widths.
Auto Color Measurement Device Mounter	Available for all paper widths.
Auto Take-up Reel Unit	Paper that is 254 mm/10 inches wide is not supported. Printed side out and printed side in winding is available for other paper widths.

Premium Semimatte Photo Paper (260)

Thickness	0.268 mm
Roll core size	3 inches
Paper Type (printer driver)	Photo Paper - Premium Semimatte Photo Paper (260)
Type of black ink	Photo Black (BK)
ICC profile	EPSON_SC-P9500_7500_PremiumSemimattePhotoPaper250.icc

Appendix

Paper Width	406 mm/16 inches 610 mm/24 inches 914 mm/36 inches* 1118 mm/44 inches* * SC-P7500 Series is not supported.
Borderless Printing	Available for all paper widths.
Auto Color Measurement Device Mounter	Available for all paper widths.
Auto Take-up Reel Unit	Printed side out and printed side in winding is available for all paper widths.

Premium Glossy Photo Paper (170)

Paper Thickness	0.18 mm
Roll core size	2 inches
Paper Type (printer driver)	Photo Paper - Premium Glossy Photo Paper (170)
Type of black ink	Photo Black (BK)
ICC profile	EPSON_SC-P9500_7500_PremiumGlossyPhotoPaper170.icc
Paper Width	420 mm/A2 610 mm/24 inches 728 mm/B1* 914 mm/36 inches* 1118 mm/44 inches* * SC-P7500 Series is not supported.
Borderless Printing	Paper that is 420 mm/A2 wide is not supported. Available for all paper widths.
Auto Color Measurement Device Mounter	Available for all paper widths.
Auto Take-up Reel Unit	Printed side out and printed side in winding is available for all paper widths.

Premium Semigloss Photo Paper (170)

Paper Thickness	0.18 mm
Roll core size	2 inches
Paper Type (printer driver)	Photo Paper - Premium Semigloss Photo Paper (170)
Type of black ink	Photo Black (BK)
ICC profile	EPSON_SC-P9500_7500_PremiumSemiglossPhotoPaper170.icc
Paper Width	420 mm/A2 610 mm/24 inches 914 mm/36 inches* 1118 mm/44 inches* * SC-P7500 Series is not supported.

Appendix

Borderless Printing	Paper that is 420 mm/A2 wide is not supported. Available for other paper widths.
Auto Color Measurement Device Mounter	Available for all paper widths.
Auto Take-up Reel Unit	Printed side out and printed side in winding is available for all paper widths.

Photo Paper Gloss 250

Thickness	0.25 mm
Roll core size	3 inches
Paper Type (printer driver)	Photo Paper Gloss 250
Type of black ink	Photo Black (BK)
ICC profile	EPSON_SC-P9500_7500_PhotoPaperGloss250.icc
Paper Width	432 mm/17 inches 610 mm/24 inches 914 mm/36 inches* 1118 mm/44 inches* * SC-P7500 Series is not supported.
Borderless Printing	Available for all paper widths.
Auto Color Measurement Device Mounter	Available for all paper widths.
Auto Take-up Reel Unit	Printed side out and printed side in winding is available for all paper widths.

EPSON Proofing Paper White Semimatte

Paper Thickness	0.2 mm
Roll core size	3 inches
Paper Type (printer driver)	Epson Proofing Paper White Semimatte
Type of black ink	Photo Black (BK)
ICC profile	EPSON_SC-P9500_7500_ProofingPaperWhiteSemimatte.icc
Paper Width	329 mm/13 inches 432 mm/17 inches 610 mm/24 inches 914 mm/36 inches* 1118 mm/44 inches* * SC-P7500 Series is not supported.
Borderless Printing	Not supported
Auto Color Measurement Device Mounter	Available for all paper widths.
Auto Take-up Reel Unit	Paper that is 329 mm/13 inches wide is not supported. Printed side out and printed side in winding is available for other paper widths.

Appendix

EPSON Proofing Paper Commercial

Thickness	0.196 mm
Roll core size	3 inches
Paper Type (printer driver)	EPSON Proofing Paper
Type of black ink	Photo Black (BK)
ICC profile	EPSON_SC-P9500_7500_ProofingPaperCommercial.icc
Paper Width	329 mm/13 inches 432 mm/17 inches 610 mm/24 inches 914 mm/36 inches* 1118 mm/44 inches* * SC-P7500 Series is not supported.
Borderless Printing	Not supported
Auto Color Measurement Device Mounter	Available for all paper widths.
Auto Take-up Reel Unit	Paper that is 329 mm/13 inches wide is not supported. Printed side out and printed side in winding is available for other paper widths.

Singleweight Matte

Paper Thickness	0.14 mm
Roll core size	2 inches
Paper Type (printer driver)	Singleweight Matte
Type of black ink	Matte Black (MB)
ICC profile	EPSON_SC-P9500_7500_SingleweightMattePaper.icc
Paper Width	419 mm/16.5 inches 432 mm/17 inches 610 mm/24 inches 914 mm/36 inches* 1118 mm/44 inches* * SC-P7500 Series is not supported.
Borderless Printing	Paper that is 419 mm/16.5 inches wide is not supported. Available for other paper widths.
Auto Color Measurement Device Mounter	Not supported
Auto Take-up Reel Unit	Printed out side winding is available for all paper widths. However, for 610 mm/24 inch, 914 mm/36 inch, and 1,118 mm/44 inch paper, you need to use the tensioner attached to the auto take-up reel unit.

Doubleweight Matte Paper

Thickness	0.21 mm
-----------	---------

Appendix

Roll core size	2 inches
Paper Type (printer driver)	Doubleweight Matte
Type of black ink	Matte Black (MB)
ICC profile	EPSON_SC-P9500_7500_DoubleweightMattePaper.icc
Paper Width	610 mm/24 inches 914 mm/36 inches* 1118 mm/44 inches* * SC-P7500 Series is not supported.
Borderless Printing	Available for all paper widths.
Auto Color Measurement Device Mounter	Available for all paper widths. However, color measurement accuracy is not guaranteed.
Auto Take-up Reel Unit	Printed out side winding is available for all paper widths.

Enhanced Matte Paper

Paper Thickness	0.2 mm
Roll core size	3 inches
Paper Type (printer driver)	Enhanced Matte
Type of black ink	Matte Black (MB)
ICC profile	EPSON_SC-P9500_7500_EnhancedMattePaper.icc
Paper Width	432 mm/17 inches 610 mm/24 inches 914 mm/36 inches* 1118 mm/44 inches* * SC-P7500 Series is not supported.
Borderless Printing	Not supported
Auto Color Measurement Device Mounter	Available for all paper widths. However, color measurement accuracy is not guaranteed.
Auto Take-up Reel Unit	Printed out side winding is available for all paper widths.

Watercolor Paper - Radiant White

Thickness	0.29 mm
Roll core size	3 inches
Paper Type (printer driver)	Watercolor Paper - Radiant White
Type of black ink	Matte Black (MB)
ICC profile	EPSON_SC-P9500_7500_WatercolorPaper-RadiantWhite.icc

Appendix

Paper Width	610 mm/24 inches 914 mm/36 inches* 1118 mm/44 inches* * SC-P7500 Series is not supported.
Borderless Printing	Not supported
Auto Color Measurement Device Mounter	Available for all paper widths. However, color measurement accuracy is not guaranteed.
Auto Take-up Reel Unit	Printed side out and printed side in winding is available for all paper widths.

UltraSmooth Fine Art Paper

Thickness	0.32 mm
Roll core size	3 inches
Paper Type (printer driver)	UltraSmooth Fine Art Paper
Type of black ink	Matte Black (MB)
ICC profile	EPSON_SC-P9500_7500_UltraSmoothFineArtpaper.icc
Paper Width	432 mm/17 inches 610 mm/24 inches 1118 mm/44 inches* * SC-P7500 Series is not supported.
Borderless Printing	Not supported
Auto Color Measurement Device Mounter	Available for all paper widths. However, color measurement accuracy is not guaranteed.
Auto Take-up Reel Unit	Printed side out and printed side in winding is available for all paper widths.

Enhanced Synthetic Paper

Thickness	0.12 mm
Roll core size	2 inches
Paper Type (printer driver)	Enhanced Synthetic Paper
Type of black ink	Matte Black (MB)
ICC profile	EPSON_SC-P9500_7500_EnhancedSyntheticPaper.icc
Paper Width	610 mm/24 inches 1118 mm/44 inches* * SC-P7500 Series is not supported.
Borderless Printing	Not supported
Auto Color Measurement Device Mounter	Not supported
Auto Take-up Reel Unit	Printed side out and printed side in winding is available for all paper widths.

Appendix

Enhanced Adhesive Synthetic Paper

Thickness	0.17 mm
Roll core size	2 inches
Paper Type (printer driver)	Enhanced Adhesive Synthetic Paper
Type of black ink	Matte Black (MB)
ICC profile	EPSON_SC-P9500_7500_EnhancedAdhesiveSyntheticPaper.icc
Paper Width	610 mm/24 inches 1118 mm/44 inches* * SC-P7500 Series is not supported.
Borderless Printing	Not supported
Auto Color Measurement Device Mounter	Not supported
Auto Take-up Reel Unit	Printed side out and printed side in winding is available for all paper widths.

Enhanced Low Adhesive Synthetic Paper

Paper Thickness	0.18 mm
Roll core size	2 inches
Paper Type (printer driver)	Enhanced Low Adhesive Synthetic Paper
Type of black ink	Matte Black (MB)
ICC profile	EPSON_SC-P9500_7500_EnhancedLowAdhesiveSyntheticPaper.icc
Paper Width	610 mm/24 inches 1118 mm/44 inches* * SC-P7500 Series is not supported.
Borderless Printing	Not supported
Auto Color Measurement Device Mounter	Not supported
Auto Take-up Reel Unit	Printed side out and printed side in winding is available for all paper widths.

Backlight Film Roll

Paper Thickness	0.14 mm
Roll core size	2 inches
Paper Type (printer driver)	Backlight Film Roll BK Backlight Film Roll MB
Type of black ink	Photo Black (BK), Matte Black (MB)
ICC profile	EPSON_SC-P9500_7500_BacklightFilm_PK_BK.icc EPSON_SC-P9500_7500_BacklightFilm_MK_MB.icc

Appendix

Paper Width	610 mm/24 inches 1118 mm/44 inches* * SC-P7500 Series is not supported.
Borderless Printing	Not supported
Auto Color Measurement Device Mounter	Not supported
Auto Take-up Reel Unit	Printed side out and printed side in winding is available for all paper widths.

Cut sheet

Premium Glossy Photo Paper

Paper Thickness	0.27 mm
Paper Type (printer driver)	Epson Photo Paper
Type of black ink	Photo Black (BK)
ICC profile	EPSON_SC-P9500_7500_PremiumGlossyPhotoPaper.icc
Paper Width	A3 S-B/A3+ A2
Borderless Printing	Not supported
Auto Color Measurement Device Mounter	Not supported

Premium Semigloss Photo Paper

Paper Thickness	0.27 mm
Paper Type (printer driver)	Premium Semigloss Photo Paper
Type of black ink	Photo Black (BK)
ICC profile	EPSON_SC-P9500_7500_PremiumSemiglossPhotoPaper.icc
Paper Width	A3 S-B/A3+ A2
Borderless Printing	Not supported
Auto Color Measurement Device Mounter	Only A2 size is supported.

Premium Luster Photo Paper

Paper Thickness	0.27 mm
Paper Type (printer driver)	Premium Luster Photo Paper
Type of black ink	Photo Black (BK)

Appendix

ICC profile	EPSON_SC-P9500_7500_PremiumLusterPhotoPaper.icc
Paper Width	S-B/A3+ A2
Borderless Printing	Not supported
Auto Color Measurement Device Mounter	Only A2 size is supported.

Super Fine Paper

Thickness	0.12 mm
Paper Type (printer driver)	Photo Quality Ink Jet Paper
Type of black ink	Matte Black (MB)
ICC profile	EPSON_SC-P9500_7500_PhotoQualityInkJetPaper.icc
Paper Width	A3 S-B/A3+ A2
Borderless Printing	Not supported
Auto Color Measurement Device Mounter	Not supported

Archival Matte Paper

Paper Thickness	0.2 mm
Paper Type (printer driver)	Archival Matte Paper
Type of black ink	Matte Black (MB)
ICC profile	EPSON_SC-P9500_7500_ArchivalMattePaper.icc
Paper Width	A3 S-B/A3+ A2 US-C* * SC-P7500 Series is not supported.
Borderless Printing	Not supported
Auto Color Measurement Device Mounter	Available for A2 and US-C width. However, color measurement accuracy is not guaranteed.

Enhanced Matte Paper

Paper Thickness	0.2 mm
Paper Type (printer driver)	Enhanced Matte
Type of black ink	Matte Black (MB)
ICC profile	SC-P9000_P7000_Series Pro Photo250(G).icc

Appendix

Paper Width	A2 US-C* * SC-P7500 Series is not supported.
Borderless Printing	Not supported
Auto Color Measurement Device Mounter	Supported. However, color measurement accuracy is not guaranteed.

Watercolor Paper - Radiant White

Thickness	0.29 mm
Paper Type (printer driver)	Watercolor Paper - Radiant White
Type of black ink	Matte Black (MB)
ICC profile	EPSON_SC-P9500_7500_WatercolorPaper-RadiantWhite.icc
Paper Width	S-B/A3+
Borderless Printing	Not supported
Auto Color Measurement Device Mounter	Not supported

UltraSmooth Fine Art Paper

Thickness	0.46 mm
UltraSmooth Fine Art Paper	Watercolor Paper - Radiant White
Type of black ink	Matte Black (MB)
ICC profile	EPSON_SC-P9500_7500_UltraSmoothFineArtpaper.icc
Paper Width	S-B/A3+ A2 US-C* * SC-P7500 Series is not supported.
Borderless Printing	Not supported
Auto Color Measurement Device Mounter	Available for A2 and US-C. However, color measurement accuracy is not guaranteed.

Velvet Fine Art Paper

Thickness	0.48 mm
UltraSmooth Fine Art Paper	Velvet Fine Art Paper
Type of black ink	Matte Black (MB)
ICC profile	EPSON_SC-P9500_7500_VelvetFineArtPaper.icc

Appendix

Paper Width	S-B/A3+ A2 US-C* * SC-P7500 Series is not supported.
Borderless Printing	Not supported
Auto Color Measurement Device Mounter	Available for A2 and US-C. However, color measurement accuracy is not guaranteed.

Enhanced Matte Poster Board

Thickness	1.3 mm
Paper Type (printer driver)	Enhanced Matte Poster Board
Type of black ink	Matte Black (MB)
ICC profile	EPSON_SC-P9500_7500_EnhancedMattePosterBoard.icc
Paper Width	610 mm (24") × 762 mm (30") 762 mm (30") × 1016 mm (40")* * SC-P7500 is not supported.
Borderless Printing	Not supported
Auto Color Measurement Device Mounter	Not supported

Supported Commercially Available Paper

When using commercially available paper, make sure you register the paper information.

 [“Before Printing on Commercially Available Paper” on page 180](#)

This printer supports the following paper specifications for non-Epson media.

Important:

- Do not use paper that is wrinkled, scuffed, torn, or dirty.
- Although plain paper and recycled paper manufactured by other companies can be loaded and fed in the printer as long as they meet the following specifications, Epson cannot guarantee the print quality.
- Although other paper types manufactured by other companies can be loaded in the printer as long as they meet the following specifications, Epson cannot guarantee the paper feeding and print quality.
- When using the SpectroProofer mounter, see the documentation supplied with your software RIP.

Roll Paper

Roll core size	2 inch and 3 inch
Roll paper outer diameter	2-inch core: 103 mm or less 3-inch core: 150 mm or less

Appendix

Paper Width	SC-P9500 Series: 254 mm (10 inches) to 1,118 mm (44 inches) SC-P7500 Series: 254 mm (10 inches) to 610 mm (24 inches)
Thickness	0.08 mm to 0.5 mm

Cut sheet

Paper Width	SC-P9500 Series: 182 mm to 1,118 mm (44 inches) SC-P7500 Series: 182 mm to 620 mm* ¹
Paper Length* ²	SC-P9500 Series: 254 mm to 1,580 mm (B0+) SC-P7500 Series: 254 mm to 914 mm (A1+)
Thickness	0.08 mm to 0.5 mm (0.5 mm to 1.5 mm for thick paper)

*1 The printable area is 610 mm (24 inches).

 [“Cut Sheets Printable Area” on page 59](#)

*2 762 mm for thick paper.

254 mm/10 inch, 300 mm/11.8 inch, Super A3/B/329 mm/13 inch, 406 mm/16 inch, US C/ 432 mm/17 inch, B2/515 mm, A1/594 mm, Super A1/610 mm/24 inch, B1/728 mm*, Super A0/914 mm/36 inch*, Super B0/1,118 mm/44 inch*

*Only for SC-P9500 Series

Before Printing on Commercially Available Paper

Note:

- Be sure to check the paper characteristics (such as if the paper is glossy, the material, and the thickness) in the manual provided with the paper or contact the dealer of the paper.
- Test the print quality with this printer before purchasing a large amount of paper.

When using paper such as baryta, matte fine art paper, matte canvas, satin canvas, Japanese paper, thin Japanese paper, or non-Epson media (Custom Paper), make the paper configuration according to the paper characteristics before printing. Printing without making configuring may cause wrinkles, rubbing, uneven colors, and so on.

Make sure you set the following four items.

Appendix

Select Reference Paper	<p>The optimum settings for using different types of Epson special media have already been registered to this printer.</p> <p>Check the following, and then select the Epson special media type or general paper settings that are closest to the paper you are using.</p> <p>General paper settings</p> <p>General paper settings have not been optimized for any specific paper type. You can then optimize the settings according to the paper provided by the user.</p> <ul style="list-style-type: none"> <input type="checkbox"/> Photo Paper: Baryta <input type="checkbox"/> Fine Art Paper: Matte fine art paper, thin Japanese paper, Japanese paper <input type="checkbox"/> Canvas: satin canvas, matte canvas <input type="checkbox"/> Plain paper: Plain paper <input type="checkbox"/> Glossy paper: Photo Paper or Proofing Paper <input type="checkbox"/> Thick paper that is not glossy: Matte Paper <input type="checkbox"/> Thin, soft paper that is not glossy; Plain Paper <input type="checkbox"/> Canvas-like paper: Canvas <input type="checkbox"/> Cotton paper with an uneven surface: Fine Art Paper <input type="checkbox"/> Special media such as film, cloth, poster board, and tracing paper: Others
Paper Thickness	<p>Set the thickness of the paper. If you do not know the paper thickness, check the manual supplied with the paper or the paper supplier.</p> <p>This allows you to reduce the grainy feeling and scuff marks in print outs, as well as differences in the print position and color.</p>
Roll core size	Set the paper core size for the roll paper being loaded.
Paper Feed Offset	<p>Optimizes the paper feed when printing. By adjusting the gap between the data size and the print size, you can reduce the chance of banding (horizontal banding) or uneven colors.</p> <p>Example of entering settings</p> <p>When printing at a data size of 100 mm and a print size of 101 mm, the offset is 1.0%. Therefore, you would enter a value of -1.0%.</p>

 **Important:**

*If you change one item set in the Paper menu, you need to perform **Paper Feed Offset** again.*

Make custom paper settings on the control panel

- 1 Select **General Settings - Printer Settings - Custom Paper Setting** on the control panel.

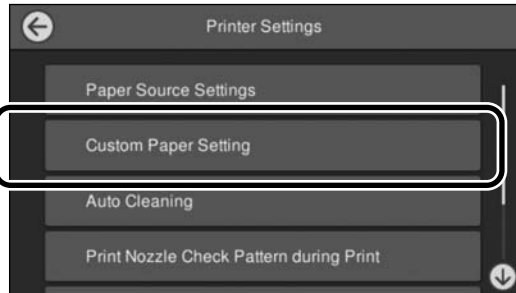

- 2 Select a paper number from 1 to 30 to save the settings.

- 3 Set the paper information.
Make sure you set the following items.

- Change Reference Paper**
- Paper Thickness**
- Roll Core Diameter** (roll paper only)
- Paper Feed Offset**

See the following for details on the other settings.

[🔗 "Menu List" on page 111](#)

When using this from the printer driver, select "Use Printer Settings" in "Paper Type".

PANTONE Color Explanation

There are many variables in the process reproduction of colors generated by the SC-P9500 Series/SC-P7500 Series, any one of which may affect the quality of the PANTONE Color simulation.

For optimal results, we recommend that the following driver and materials use.

Print Quality (Printer Driver): Max Quality

Media: Epson Proofing Paper White Semimatte

Ink: Genuine Epson ink

Notes When Moving or Transporting the Printer

This section describes precaution when moving and transporting the product.

Notes When Moving the Printer

This section assumes that the product is being moved to another location on the same floor without traversing stairs, ramps, or lifts. See the following section for information on moving the printer between floors or to another building.

[🔗 "Notes on Transporting" on page 183](#)

Caution:

Do not tilt the product more than 10 degrees forward or back while moving it. Failure to observe this precaution could result in the printer falling over, causing accidents.

Important:

Do not remove the ink cartridges. Failure to observe this precaution could cause the print head nozzles to dry out.

Getting Ready

- 1 Remove any paper from the printer.
- 2 Make sure the printer is turned off and the screen has turned off, and then unplug the power cable from the outlet.
- 3 Disconnect the power cords and all other cables.

Appendix

- 4 Place the roll section of the paper basket as shown in the image.



- 5 Remove the optional auto take-up reel unit or SpectroProofer mounter if they are installed.

☞ Setup Guide (booklet) supplied with optional items

- 6 Unlock the casters.

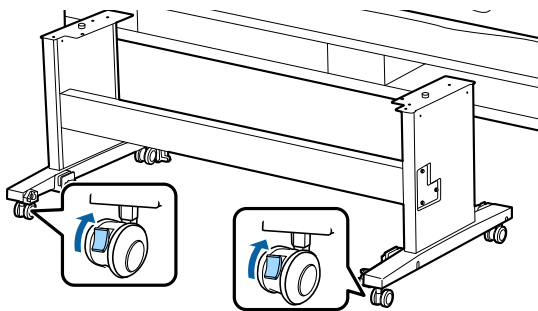

- 7 Move the printer.

! Important:

Use the casters to move the printer indoors a short distance over a level floor. They can not be used for transport.

- ❑ Remove any optional components if they are installed.
To remove the optional components, see the *Setup guide* included with each of them, and then reverse the attachment procedure.

Furthermore, repack it using the original box and packing materials to protect it from shock and vibration.

When packing, make sure you install protective material to secure the print head.

See the "Setup Guide" (booklet) supplied with the printer for the installation method, and install in the original location before the printer was removed.

! Caution:

- ❑ *The printer is heavy. When you pack or move the printer, use four or more people when carrying it. Also, make sure there is another person to guide the people carrying the printer.*
- ❑ *When you lift the printer, maintain a natural posture.*
- ❑ *When you lift the printer, place your hands at the locations indicated in the following illustration.*
If you lift the printer while holding other sections, you may be injured. For example, you may drop the printer or your fingers may be pinched when lowering the printer.

Notes on Transporting

Make the following preparations in advance before transporting the printer.

- ❑ Remove any paper.
- ❑ **Touch Maintenance - Keeping/Transporting Preparation - Personal Transport Preparation** from the control panel. Ink is discharged. When the ink has been discharged, the printer turns off.
- ❑ Disconnect all of the cables.

Appendix

When you move the printer while packaging it, place your hands at the positions in the illustration, and then lift.

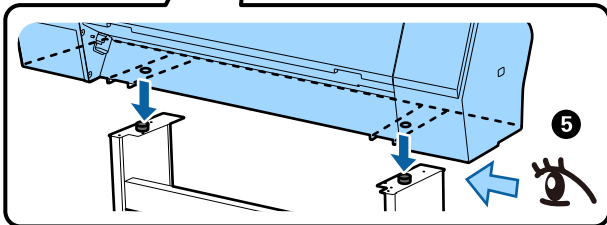
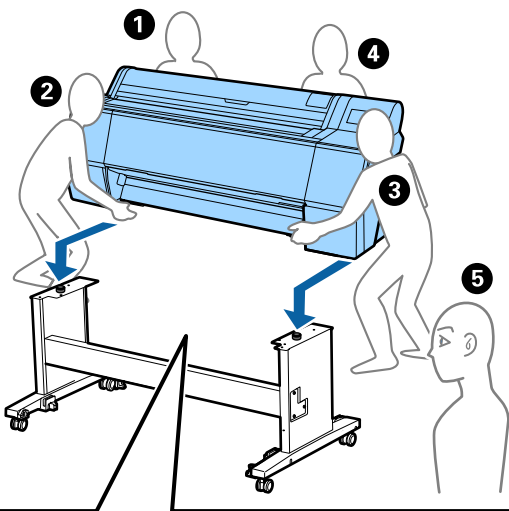
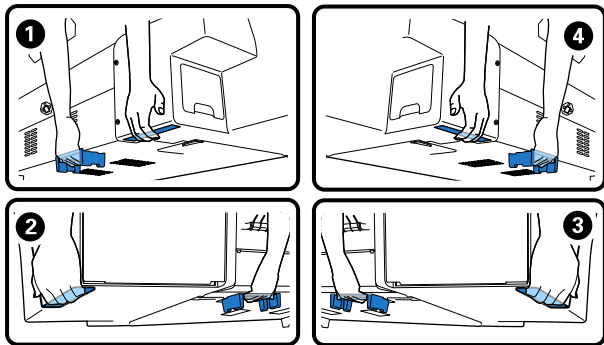

Important:

- ❑ Only hold the required area; otherwise, the printer may be damaged. Failure to observe this precaution could damage the printer.
- ❑ Move and transport the printer with ink cartridges installed. Do not remove the ink cartridges; otherwise, the nozzles may be clogged and make it impossible to print, or ink may leak.

Notes when reusing the printer

After moving or transporting the printer, follow the steps below to put it into a ready status.

See the Choosing a Place for the Printer section of the "Setup Guide" (booklet) in advance to make sure the location is suitable for installing the printer.

- 1 See the "Setup Guide" to install the printer.
 ↗ "Setup Guide" (booklet)

Important:
 Make sure you lock the casters after installing the printer.

- 2 Follow the on-screen instructions to fill the ink.
- 3 Check the print head nozzles.
 ↗ "Print Head Nozzle Check" on page 125

Appendix

System Requirements

Software for this printer can be used in the following environments. (As of November, 2019)
Supported OS and other elements may change.

For the latest information, see the Epson Web site.

Printer Driver

Windows

Operating system	Windows 10/Windows 10 x64 Windows 8.1/Windows 8.1 x64 Windows 8/Windows 8 x64 Windows 7/Windows 7 x64 Windows Vista/Windows Vista x64 Windows XP/Windows XP x64 Windows Server 2019 Windows Server 2016 Windows Server 2012 R2 Windows Server 2012 Windows Server 2008 R2 Windows Server 2008 Windows Server 2003 R2 Windows Server 2003 SP2 or later
CPU	Intel Core2 Duo 3.05 GHz or more
Available memory space	1 GB or more
Hard disk (Available volume to install)	32 GB or more
Display resolution	WXGA (1280×800) or better
Connection method with the printer*	USB connection or wired LAN connection

* For details on the connection methods (interface specifications), see the following.

 ["Specifications Table" on page 188](#)

Mac

Operating system	Mac OS X v10.6.8 or later
CPU	Intel Core2 Duo 3.05 GHz or more
Available memory space	1 GB or more
Hard disk (Available volume to install)	32 GB or more
Display resolution	WXGA+ (1440×900) or better
Connection method with the printer*	USB connection or wired LAN connection

* For details on the connection methods (interface specifications), see the following.

 ["Specifications Table" on page 188](#)

Appendix

Web Config

Web Config is software installed in the printer that will run in a web browser on a computer or smart device connected to the same network as the printer.

 *Administrator's Guide*

Windows

Browser	Internet Explorer 11, Microsoft Edge, Firefox ^{*1} , Chrome ^{*1}
Connection method with the printer ^{*2}	Wired LAN connection

*1 Use the latest version.

*2 See the following for details on the network interfaces.

 ["Specifications Table" on page 188](#)

Mac

Browser	Safari ^{*1} , Firefox ^{*1} , Chrome ^{*1}
Connection method with the printer ^{*2}	Wired LAN connection

*1 Use the latest version.

*2 See the following for details on the network interfaces.

 ["Specifications Table" on page 188](#)

Appendix

Epson Edge Dashboard

 **Important:**

Make sure the computer on which the Epson Edge Dashboard is installed meets the following requirements.

If these requirements are not met, the software cannot monitor the printer correctly.

- Disable your computer's hibernate function.
- Disable the sleep function so that the computer does not enter sleep status.

Windows

Operating system	Windows 10/Windows 10 x64 Windows 8.1/Windows 8.1 x64 Windows 8/Windows 8 x64 Windows 7 SP1/Windows 7 x64 SP1
CPU	Multi-core processor (3.0 GHz or faster recommended)
Available memory space	4 GB or more
Hard disk (Available volume to install)	2 GB or more
Display resolution	1280 x 1024 or higher
Connection method with the printer	High Speed USB Ethernet 1000Base-T
Browser	Internet Explorer 11 Microsoft Edge

Mac

Operating system	Mac OS X 10.7 Lion or later
CPU	Multi-core processor (3.0 GHz or faster recommended)
Available memory space	4 GB or more
Hard disk (Available volume to install)	2 GB or more
Display resolution	1280 x 1024 or higher
Connection method with the printer	High Speed USB Ethernet 1000Base-T
Browser	Safari 6 or higher

Appendix

Specifications Table

The (A) to (D) letters used in the table represent the printer models as shown below.

(A): SC-P9500 Series

(B): SC-P7500 Series

Printer Specifications	
Printing method	On-demand ink jet
Nozzle configuration	800 nozzles x 12 colors (Cyan, Vivid Magenta, Yellow, Light Cyan, Vivid Light Magenta, Orange, Green, Violet, Photo Black, Matte Black, Gray, Light Gray)
Resolution (maximum)	2400 x 1200 dpi
Control code	ESC/P raster (undisclosed command)
Media feed method	Friction feed
Built-in memory	2.0 GB
Rated voltage	AC100-240 V
Rated frequency	50/60 Hz
Rated current	3.4 - 1.6 A
Power consumption	
In use	(A): Approx. 110 W (B): Approx. 85 W
Ready mode	Approx. 32 W
Sleep mode	Approx. 3.4 W
Power off	Approx. 0.3 W
Temperature	
In use	10 to 35 °C (15 to 25°C is recommended)
In storage (Before unpacking)	-20 to 60 °C (Within 120 hours at 60 °C, within a month at 40 °C)
In storage (After unpacking)	Ink charged: -10 to 40 °C (Within a month at 40 °C) After ink discharged*1: -20 to 25 °C (Within a month at 25 °C)

Printer Specifications	
Humidity	
In use	20 to 80% (40 to 60% is recommended, without condensation)
In storage	5 to 85% (without condensation)
Temperature and humidity range for operating (the range shown by diagonal lines is recommended)	
Dimensions (Width x Depth x Height)	
Printing*2	(A): 1909 x 2211 x 1218 mm (B): 1401 x 2211 x 1218 mm
Storage	(A): 1909 x 667 x 1218 mm (B): 1401 x 667 x 1218 mm
Weight*3	(A): Approx. 153.8 kg (B): Approx. 121.8 kg

*1 Use the **Keeping/Transporting Preparation** menu in the Maintenance menu to discharge ink from the printer.

User's Guide (online manual)

*2 With the paper basket open

*3 Not including the ink cartridges



Important:

Use the printer at an altitude of 2000 m or less.

Interface Specifications	
USB port for a computer	Hi-Speed USB

Appendix

Interface Specifications	
Ethernet* ¹ Standards	IEEE802.3u (100BASE-TX) IEEE802.3ab (1000BASE-T) IEEE802.3az (Energy Efficient Ethernet)* ²
Network Print- ing Protocols/Func- tions* ³	EpsonNet Print (Windows) Standard TCP/IP (Windows) WSD Printing (Windows) Bonjour Printing (Mac) IPP Printing (Mac) Printing from FTP client
Security Protocols	SSL/TLS (HTTPS Server/Client, IPPS) IEEE802.1X IPsec/IP Filtering SMTPS (STARTTLS, SSL/TLS) SNMPv3

*1 Use a category 5 or higher STP (Shielded twisted pair) cable.

*2 The connected device should comply with IEEE802.3az standards.

*3 EpsonNet Print supports IPv4 only. The others support both IPv4 and IPv6.

Ink Specifications	
Type	Special ink cartridges
Pigment ink	(Cyan, Vivid Magenta, Yellow, Light Cyan, Vivid Light Magenta, Orange, Green, Violet, Photo Black, Matte Black, Gray, Light Gray)
Use by date	See the date printed on the package (at normal temperature)
Print quality guar- antee expiry	One year (after installing to the printer)
Storage temperature	
Uninstalled	-20 to 40°C (Within four days at -20 °C, within a month at 40 °C)
Installed	-10 to 40°C (Within four days at -10 °C, within a month at 40 °C)
Transporting	-20 to 60°C (Within four days at -20 °C, within a month at 40 °C, within 72 hours at 60 °C)
Cartridge capacities	700 ml, 350 ml, 150 ml



Important:

- ❑ We recommend that you remove and shake the installed ink cartridges once every six months to ensure good print quality.
- ❑ The ink freezes if left at below -20 °C for a long time. If it does freeze, leave it at room temperature (25 °C) for at least four hours.
- ❑ Do not refill the ink cartridges.

Where To Get Help

Technical Support Web Site

Epson's Technical Support Web Site provides help with problems that cannot be solved using the troubleshooting information in your product documentation. If you have a Web browser and can connect to the Internet, access the site at:

<https://support.epson.net/>

If you need the latest drivers, FAQs, manuals, or other downloadables, access the site at:

<https://www.epson.com>

Then, select the support section of your local Epson Web site.

Contacting Epson Support

Before Contacting Epson

If your Epson product is not operating properly and you cannot solve the problem using the troubleshooting information in your product documentation, contact Epson support services for assistance. If Epson support for your area is not listed below, contact the dealer where you purchased your product.

Epson support will be able to help you much more quickly if you give them the following information:

- Product serial number
(The serial number label is usually on the back of the product.)
- Product model
- Product software version
(Click **About**, **Version Info**, or similar button in the product software.)
- Brand and model of your computer
- Your computer operating system name and version
- Names and versions of the software applications you normally use with your product

Where To Get Help

Help for Users in North America

Epson provides the technical support services listed below.

Internet Support

Visit Epson's support website at <https://epson.com/support> and select your product for solutions to common problems. You can download drivers and documentation, get FAQs and troubleshooting advice, or e-mail Epson with your questions.

Speak to a Support Representative

Dial: (562) 276-1300 (U.S.), or (905) 709-9475 (Canada), 6 am to 6 pm, Pacific Time, Monday through Friday. Days and hours of support are subject to change without notice. Toll or long distance charges may apply.

Before you call Epson for support, please have the following information ready:

- Product name
- Product serial number
- Proof of purchase (such as a store receipt) and date of purchase
- Computer configuration
- Description of the problem

Note:

For help using any other software on your system, see the documentation for that software for technical support information.

Purchase Supplies and Accessories

You can purchase genuine Epson ink cartridges, ribbon cartridges, paper, and accessories from an Epson authorized reseller. To find the nearest reseller, call 800-GO-EPSON (800-463-7766). Or you can purchase online at <https://www.epsonstore.com> (U.S. sales) or <https://www.epson.ca> (Canadian sales).

Help for Users in Europe

Check your **Pan-European Warranty Document** for information on how to contact Epson support.

Help for Users in Taiwan

Contacts for information, support, and services are:

World Wide Web

(<https://www.epson.com.tw>)

Information on product specifications, drivers for download, and products enquiry are available.

Epson HelpDesk

(Phone: +0800212873)

Our HelpDesk team can help you with the following over the phone:

- Sales enquiries and product information
- Product usage questions or problems
- Enquiries on repair service and warranty

Repair service center:

Telephone number	Fax number	Address
02-23416969	02-23417070	No.20, Beiping E. Rd., Zhongzheng Dist., Taipei City 100, Taiwan
02-27491234	02-27495955	1F., No.16, Sec. 5, Nanjing E. Rd., Songshan Dist., Taipei City 105, Taiwan
02-32340688	02-32340699	No.1, Ln. 359, Sec. 2, Zhongshan Rd., Zhonghe City, Taipei County 235, Taiwan
039-605007	039-600969	No.342-1, Guangrong Rd., Luodong Township, Yilan County 265, Taiwan
038-312966	038-312977	No.87, Guolian 2nd Rd., Hualien City, Hualien County 970, Taiwan

Where To Get Help

Telephone number	Fax number	Address
03-4393119	03-4396589	5F., No.2, Nandong Rd., Pingzhen City, Taoyuan County 32455, Taiwan (R.O.C.)
03-5325077	03-5320092	1F., No.9, Ln. 379, Sec. 1, Jingguo Rd., North Dist., Hsinchu City 300, Taiwan
04-23011502	04-23011503	3F., No.30, Dahe Rd., West Dist., Taichung City 40341, Taiwan (R.O.C.)
04-23805000	04-23806000	No.530, Sec. 4, Henan Rd., Nantun Dist., Taichung City 408, Taiwan
05-2784222	05-2784555	No.463, Zhongxiao Rd., East Dist., Chiayi City 600, Taiwan
06-2221666	06-2112555	No.141, Gongyuan N. Rd., North Dist., Tainan City 704, Taiwan
07-5520918	07-5540926	1F., No.337, Minghua Rd., Gushan Dist., Kaohsiung City 804, Taiwan
07-3222445	07-3218085	No.51, Shandong St., Sanmin Dist., Kaohsiung City 807, Taiwan
08-7344771	08-7344802	1F., No.113, Shengli Rd., Pingtung City, Pingtung County 900, Taiwan

Help for Users in Australia/New Zealand

Epson Australia/New Zealand wishes to provide you with a high level of customer service. In addition to your product documentation, we provide the following sources for obtaining information:

Your Dealer

Don't forget that your dealer can often help identify and resolve problems. The dealer should always be the first call for advise on problems; they can often solve problems quickly and easily as well as give advise on the next step to take.

Internet URL

Australia

<https://www.epson.com.au>

New Zealand

<https://www.epson.co.nz>

Access the Epson Australia/New Zealand World Wide Web pages.

The site provides a download area for drivers, Epson contact points, new product information and technical support (e-mail).

Epson Helpdesk

Epson Helpdesk is provided as a final backup to make sure our clients have access to advice. Operators on the Helpdesk can aid you in installing, configuring and operating your Epson product. Our Pre-sales Helpdesk staff can provide literature on new Epson products and advise where the nearest dealer or service agent is located. Many types of queries are answered here.

The Helpdesk numbers are:

Australia	Phone:	1300 361 054
	Fax:	(02) 8899 3789
New Zealand	Phone:	0800 237 766

We encourage you to have all the relevant information on hand when you ring. The more information you prepare, the faster we can help solve the problem. This information includes your Epson product documentation, type of computer, operating system, application programs, and any information you feel is required.

Help for Users in Singapore

Sources of information, support, and services available from Epson Singapore are:

Where To Get Help

World Wide Web

(<https://www.epson.com.sg>)

Information on product specifications, drivers for download, Frequently Asked Questions (FAQ), Sales Enquiries, and Technical Support via e-mail are available.

Epson HelpDesk

(Phone: (65) 6586 3111)

Our HelpDesk team can help you with the following over the phone:

- Sales enquiries and product information
- Product usage questions or problems
- Enquiries on repair service and warranty

Help for Users in Thailand

Contacts for information, support, and services are:

World Wide Web

(<https://www.epson.co.th>)

Information on product specifications, drivers for download, Frequently Asked Questions (FAQ), and e-mail are available.

Epson Hotline

(Phone: (66) 2685 -9899)

Our Hotline team can help you with the following over the phone:

- Sales enquiries and product information
- Product usage questions or problems
- Enquiries on repair service and warranty

Help for Users in Vietnam

Contacts for information, support, and services are:

Epson Hotline (Phone): 84-8-823-9239

Service Center: 80 Truong Dinh Street,
District 1, Hochiminh City
Vietnam

Help for Users in Indonesia

Contacts for information, support, and services are:

World Wide Web

(<https://www.epson.co.id>)

- Information on product specifications, drivers for download
- Frequently Asked Questions (FAQ), Sales Enquiries, questions through e-mail

Epson Hotline

- Sales enquiries and product information
- Technical support
 - Phone (62) 21-572 4350
 - Fax (62) 21-572 4357

Epson Service Center

Jakarta Mangga Dua Mall 3rd floor No 3A/B
Jl. Arteri Mangga Dua,
Jakarta

Phone/Fax: (62) 21-62301104

Bandung Lippo Center 8th floor
Jl. Gatot Subroto No.2
Bandung

Phone/Fax: (62) 22-7303766

Surabaya Hitech Mall It IIB No. 12
Jl. Kusuma Bangsa 116 – 118
Surabaya

Phone: (62) 31-5355035

Fax: (62)31-5477837

Where To Get Help

Yogyakarta	Hotel Natour Garuda Jl. Malioboro No. 60 Yogyakarta
	Phone: (62) 274-565478
Medan	Wisma HSBC 4th floor Jl. Diponegoro No. 11 Medan
	Phone/Fax: (62) 61-4516173
Makassar	MTC Karebosi Lt. III Kav. P7-8 Jl. Ahmad Yani No.49 Makassar
	Phone: (62)411-350147/411-350148

Help for Users in Hong Kong

To obtain technical support as well as other after-sales services, users are welcome to contact Epson Hong Kong Limited.

Internet Home Page

Epson Hong Kong has established a local home page in both Chinese and English on the Internet to provide users with the following information:

- Product information
- Answers to Frequently Asked Questions (FAQs)
- Latest versions of Epson product drivers

Users can access our World Wide Web home page at:

<https://www.epson.com.hk>

Technical Support Hotline

You can also contact our technical staff at the following telephone and fax numbers:

Phone: (852) 2827-8911

Fax: (852) 2827-4383

Help for Users in Malaysia

Contacts for information, support, and services are:

World Wide Web

<https://www.epson.com.my>

- Information on product specifications, drivers for download
- Frequently Asked Questions (FAQ), Sales Enquiries, questions through e-mail

Epson Trading (M) Sdn. Bhd.

Head Office.

Phone: 603-56288288

Fax: 603-56288388/399

Epson Helpdesk

- Sales enquiries and product information (Infoline)
Phone: 603-56288222
- Enquiries on repair services & warranty, product usage and technical support (Techline)
Phone: 603-56288333

Help for Users in India

Contacts for information, support, and services are:

World Wide Web

<https://www.epson.co.in>

Information on product specifications, drivers for download, and products enquiry are available.

Epson India Head Office - Bangalore

Phone: 080-30515000

Fax: 30515005

Where To Get Help

Epson India Regional Offices:

Location	Telephone number	Fax number
Mumbai	022-28261515 /16 /17	022-28257287
Delhi	011-30615000	011-30615005
Chennai	044-30277500	044-30277575
Kolkata	033-22831589 / 90	033-22831591
Hyderabad	040-66331738/ 39	040-66328633
Cochin	0484-2357950	0484-2357950
Coimbatore	0422-2380002	NA
Pune	020-30286000 / 30286001 /30286002	020-30286000
Ahmedabad	079-26407176 / 77	079-26407347

Helpline

For Service, Product info or to order a cartridge
- 18004250011 (9AM - 9PM) - This is a Toll-free number.

For Service (CDMA & Mobile Users) - 3900 1600
(9AM - 6PM) Prefix local STD code

Help for Users in the Philippines

To obtain technical support as well as other after sales services, users are welcome to contact the Epson Philippines Corporation at the telephone and fax numbers and e-mail address below:

Trunk Line: (63-2) 706 2609

Fax: (63-2) 706 2665

Helpdesk (63-2) 706 2625

Direct Line:

E-mail: epchelpdesk@epc.epson.com.ph

World Wide Web

(<https://www.epson.com.ph>)

Information on product specifications, drivers for download, Frequently Asked Questions (FAQ), and E-mail Enquiries are available.

Toll-Free No. 1800-1069-EPSON(37766)

Our Hotline team can help you with the following over the phone:

- Sales enquiries and product information
- Product usage questions or problems
- Enquiries on repair service and warranty