

EPSON STYLUS™ PHOTO RX600

All in One Product

All rights reserved. No part of this publication may be reproduced, stored in a retrieval system, or transmitted in any form or by any means, electronic, mechanical, photocopying, recording, or otherwise, without the prior written permission of Seiko Epson Corporation. The information contained herein is designed only for use with this product. Epson is not responsible for any use of this information as applied to other printers.

Neither Seiko Epson Corporation nor its affiliates shall be liable to the purchaser of this product or third parties for damages, losses, costs, or expenses incurred by the purchaser or third parties as a result of accident, misuse, or abuse of this product or unauthorized modifications, repairs, or alterations to this product, or (excluding the U.S.) failure to strictly comply with Seiko Epson Corporation's operating and maintenance instructions.

Seiko Epson Corporation shall not be liable for any damages or problems arising from the use of any options or any consumable products other than those designated as Original Epson Products or Epson Approved Products by Seiko Epson Corporation.

Seiko Epson Corporation shall not be held liable for any damage resulting from electromagnetic interference that occurs from the use of any interface cables other than those designated as Epson Approved Products by Seiko Epson Corporation.

EPSON® is a registered trademark and EPSON Stylus™ is a trademark of Seiko Epson Corporation.

Copyright 2001 Seiko Epson Corporation. All rights reserved. PRINT Image Matching™ is a trademark of Seiko Epson Corporation. The PRINT Image Matching logo is a trademark of Seiko Epson Corporation.

Copyright 2002 Seiko Epson Corporation. All rights reserved. USB DIRECT-PRINT™ is a trademark of Seiko Epson Corporation. The USB DIRECT-PRINT logo is a trademark of Seiko Epson Corporation.

The *Bluetooth* word mark and logos are owned by the Bluetooth SIG, Inc. and any use of such marks by Seiko Epson Corporation is under license.

Microsoft® and Windows® are registered trademarks of Microsoft Corporation.

Apple® and Macintosh® are registered trademarks of Apple Computer, Inc.

DPOF™ is a trademark of CANON INC., Eastman Kodak Company, Fuji Photo Film Co., Ltd. and Matsushita Electric Industrial Co., Ltd.

SD™ is a trademark.

Memory Stick and Memory Stick PRO are trademarks of Sony Corporation.

xD-Picture Card™ is a trademarks of Fuji Photo Film Co.,Ltd.

General Notice: Other product names used herein are for identification purposes only and may be trademarks of their respective owners. Epson disclaims any and all rights in those marks.

Copyright © 2003 by Seiko Epson Corporation, Nagano, Japan.

Getting Started

Parts

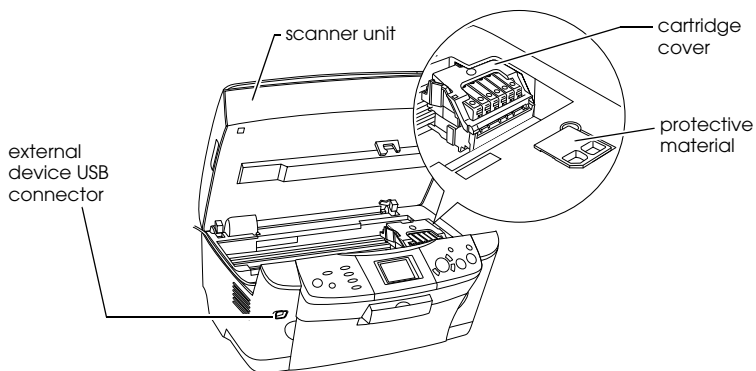
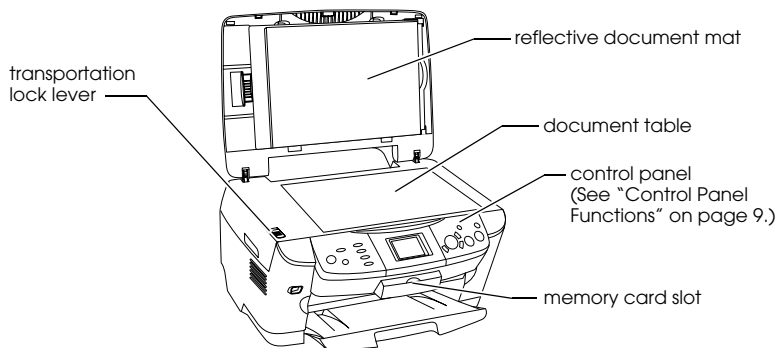
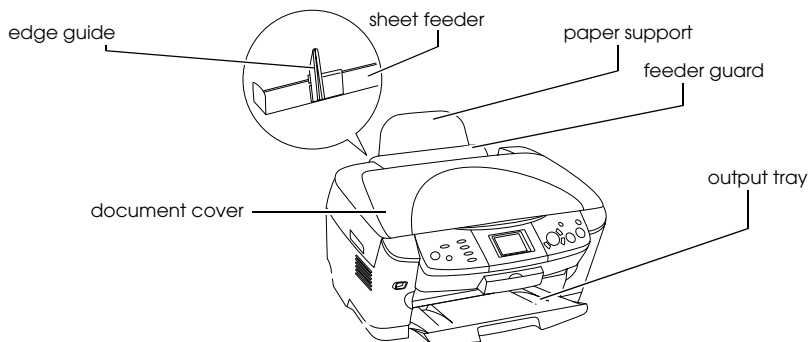

Contents

Safety Instructions

Important Safety Instructions	5
Warnings, Cautions, and Notes	8

Using the Control Panel

Control Panel Functions	9
-----------------------------------	---

Copying

Overview of the Basic Procedure	12
Loading Paper	13
Placing a Document on the Document Table	16
Changing the Copy Layout	17
Changing Copy Setting	18
Notice and useful tips for copying	19

Printing Directly from a Memory Card

Loading Memory Cards	23
Printing Basics	26
Printing with Various Settings	27
Printing Enlarged Images	28
Printing Using an Index Sheet	30
Printing an Index	32
Printing with DPOF Functions	33
Printing with PRINT Image Framer	34
Selecting Photos and Printing Options	36
Changing Print Settings	37

Printing from Film

Printing Basics	41
Printing with Various Settings	42
Printing Enlarged Images	43
Selecting the Film Type	44
Changing Print Settings	44
Loading and Setting Film on the Document Table	45

Scanning by Using the LCD Panel and Buttons

Scanning and Saving a reflective document to a Memory Card	49
Scanning and Saving a film to a Memory Card	51

Using Additional Features

Printing Directly from a Digital Camera	53
Saving the Images Stored in the Memory Card to an External Device (Backup)	54

Replacing Ink Cartridges

Ink Cartridges	56
Checking the Ink Level	56
Precautions on Ink Cartridge Replacement	57
Replacing an Ink Cartridge	58
Summary of Panel Setting	62

Safety Instructions

Important Safety Instructions

Read all of the instructions in this section when setting up and using this product.

When placing this product

- ❑ Avoid places subject to rapid changes in temperature and humidity. Also, keep this product away from direct sunlight, strong light, and heat sources.
- ❑ Avoid places subject to dust, shocks, or vibrations.
- ❑ Leave enough room around this product for sufficient ventilation.
- ❑ Place this product near a wall outlet where you can easily plug in and unplug this product.
- ❑ Place this product on a flat, stable surface that extends beyond the base of this product in all directions. If you place this product by the wall, leave more than 10 cm between the back of this product and the wall. This product will not operate properly if it is tilted at an angle.
- ❑ When storing or transporting this product, do not tilt it, stand it on its side, or turn it upside down. Otherwise ink may leak from the cartridge.

When choosing a power source

- ❑ Do not open the ink cartridge packages until just before you install them.
- ❑ Do not shake the ink cartridges; this can cause leakage.

- ❑ The IC chip on this ink cartridge retains a variety of cartridge related-information, such as the amount of ink remaining, so that a cartridge may be removed and reinserted freely. However, each time the cartridge is inserted, some ink is consumed because the printer automatically performs a reliability check.
- ❑ Use only the type of power source indicated on the label on the back of this product.
- ❑ Use only the power cord that comes with this product. Use of another cord may result in fire or electric shock.
- ❑ This product's power cord is for use with this product only. Use with other equipment may cause fire or electric shock.
- ❑ Be sure your AC power cord meets the relevant local safety standards.
- ❑ Do not use a damaged or frayed power cord.
- ❑ If you use an extension cord with this product, make sure that the total ampere rating of the devices plugged into the extension cord does not exceed the cord's ampere rating. Also, make sure that the total ampere rating of all devices plugged into the wall outlet does not exceed the wall outlet's ampere rating.
- ❑ If you plan to use this product in Germany, the building installation must be protected by a 10 or 16 amp circuit breaker to provide adequate short-circuit protection and over-current protection for this product.

When using this product

- ❑ Do not put your hand inside this product or touch the ink cartridges during printing.
- ❑ Do not block or cover the vents and openings in this product.
- ❑ Do not attempt to service this product by yourself.
- ❑ Do not insert objects into the slots on this product.
- ❑ Take care not to spill liquid on this product.

- ❑ Leave the ink cartridges installed. Removing the cartridges can dehydrate the print head and may prevent this product from printing.
- ❑ Unplug this product and refer servicing to qualified service personnel under the following conditions:
The power cord or plug is damaged; liquid has entered into this product; this product has been dropped or the cover damaged; this product does not operate normally or exhibits a distinct change in performance.

When using a memory card

- ❑ Do not remove the memory card or turn off this product while the computer and the memory card are communicating (when the memory card light is flashing).
- ❑ The methods for using memory cards vary according to card type. Be sure to refer to the documentation packaged with your memory card for details.
- ❑ Use only memory cards compatible with this product. Refer to “Loadable memory card” on page 23.

When handling ink cartridges

- ❑ Be careful not to break the hooks on the side of the ink cartridge when you remove it from the package.
- ❑ Keep the ink cartridge out of the reach of children. Do not allow children to handle it, or drink ink.
- ❑ Be careful when you handle used ink cartridges, as there may be some ink remaining around the ink supply port. If ink gets on your skin, wash the area thoroughly with soap and water. If ink gets into your eyes, flush them immediately with water. If discomfort or vision problems remain after a thorough flushing, see a doctor immediately.

- ❑ Do not touch the green IC chip on the side of the cartridge. This can damage the ink cartridge.

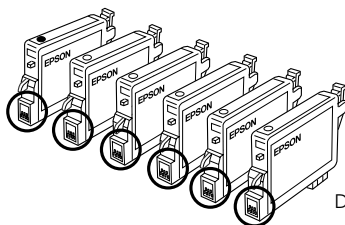

Do not touch the circled parts.

- ❑ Do not remove or tear the label on the cartridge; otherwise, ink will leak.

When using the LCD panel

- ❑ Only use a dry, soft cloth to clean the display. Do not use liquid or chemical cleansers.
- ❑ If the display on this product is damaged, contact your dealer.
- ❑ If the liquid crystal solution contained in the LCD panel leaks out and gets on your hands, wash them thoroughly with soap and water, if the liquid crystal solution gets into your eyes, flush them immediately with water, if discomfort or vision problems remain after a thorough flushing, see a doctor immediately.

Warnings, Cautions, and Notes



Warnings

must be followed carefully to avoid bodily injury.



Cautions

must be observed to avoid damage to your equipment.

Notes

Contain important information and useful tips on the operation of your printer.

Using the Control Panel

Control Panel Functions

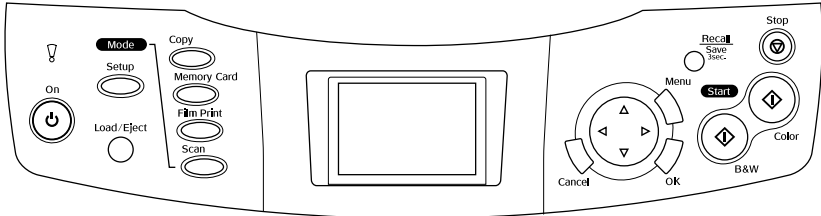





LCD panel

Displays a preview of the selected images, items or settings which can be changed with the buttons and error messages. For details about error messages, see the online *Basic Operation Guide*.

Lights

Light	Pattern	Status
! Error	On	An error occurs. (For details, see the online <i>Basic Operation Guide</i>)
Mode (Copy, Memory Card, Film Print, Scan)	On	Shows the mode this product is in.

Buttons

Buttons	Function
 On	Turns this product on and off.
Setup	Enters the Setup Mode.
Load/Eject	Loads or ejects a paper.
Copy	Enters the Copy Mode.
Memory Card	Enters the Memory Card Mode.
Film Print	Enters the Film Print Mode.
Scan	Enters the Scan Mode.
Cancel	Cancels the operation and returns to the previous menu.
OK	Enters the settings you have selected.
Menu	Displays menu items.
Recall/ Save 3 sec.	Saves current settings by pressing and holding this button for 3 seconds when this product is in the Copy mode. By pressing this button for less than 3 seconds, you can recall the saved settings.
 B&W	Copies or prints in grayscale.
 Color	Copies, prints, or scans in color.
 Stop	Stops copying, printing, or scanning. The sheet being copied or printed is ejected.
 4-Way Scroll	Select the menu items.

Adjusting the LCD panel density

1. Press the Setup button.
2. Select LCD Contrast Adjustment.

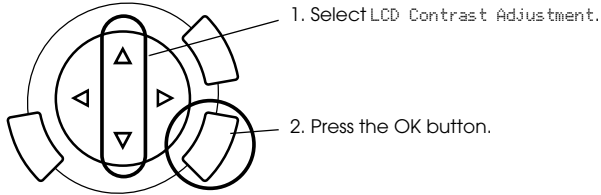

3. Adjust the density of the LCD panel. Press the ▶ button to make the panel lighter, or the ◀ button to make it darker.
4. When the adjustment is finished, press the OK button.

Copying



Before copying, read “Notice and useful tips for copying” on page 19.

Overview of the Basic Procedure

1. Press the Copy button.
2. Load paper and place the original document (see “Loading Paper” on page 13 or “Placing a Document on the Document Table” on page 16).
3. You can change the copy layout if necessary (see “Changing the Copy Layout” on page 17).

Note:

Be sure to change the copy layout first before changing the copy settings because all copy settings (paper type, print quality, number of copies, paper size) return to the default values when the copy layout changes.

4. You can change the copy settings if necessary (see “Changing Copy Setting” on page 18).
5. Press the  COLOR button to copy in color, or the  B&W button to copy in grayscale.



Caution:

Never open the scanner unit while scanning or copying; otherwise, you may damage this product.

Note:

Do not pull on the paper being copied.

Loading Paper

Note:

- ❑ Always load paper before you start printing.
 - ❑ The print result is affected by the kind of paper you use. For the best quality, use the appropriate paper.
 - ❑ Keep enough space in front of this product for paper to be fully ejected.
1. Open the output tray and move the feeder guard towards you.

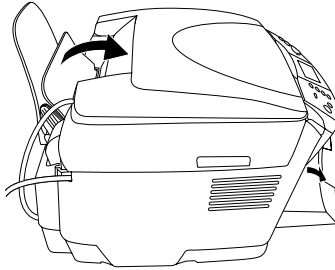

2. While holding down its locking tab, slide out the left edge guide so that the distance between the two edge guides is slightly wider than the paper you are going to load.

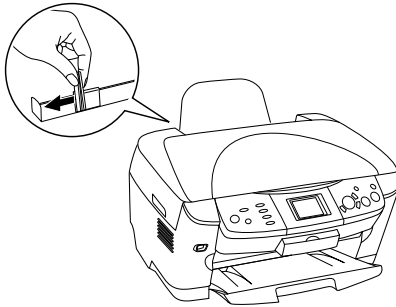

3. Fan a stack of paper, and then tap it on a flat surface to even the edges. Load the paper with the printable side facing down and resting against the guide of the feeder guard.

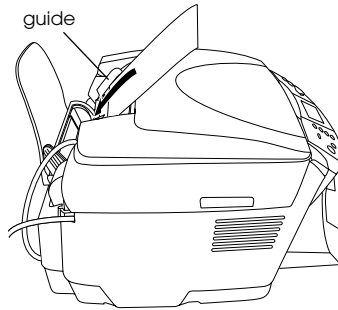

4. Stand the stack of paper against the paper support and slide the left edge guide so that it meets the left edge of the paper.

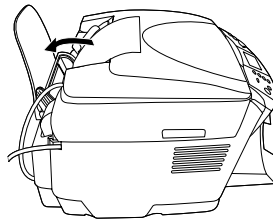

Note:

- ❑ *Always load paper into the sheet feeder's short edge first.*
 - ❑ *Make sure that the paper stack is flush with or lower than the triangular load-limit mark on the edge guide.*
 - ❑ *Make sure that the paper is loaded under the tabs inside the edge guides.*
5. Set the feeder guard back.

Note:

- *The loading capacity differs depending on the following types of paper.*

Paper Type	Paper Type Settings	Loading Capacity
Plain Paper	Plain	Up to 120 sheets
EPSON Bright White Ink Jet Paper	BrightWhite	Up to 80 sheets
EPSON Photo Quality Ink Jet Paper	PQIJ	
EPSON Photo Paper	Photo Paper	Up to 20 sheets
EPSON Matte Paper-Heavyweight	Matte	
EPSON Glossy Photo Paper	GlossyPhoto	
EPSON Premium Glossy Photo Paper	Prem. Glossy	Up to 20 sheets
EPSON Premium Semigloss Photo Paper	SemiGloss	Up to 20 sheets
EPSON Iron-On Cool Peel Transfer Paper	Iron On (only for copying)	One sheet at a time

- *You can not use Plain Paper when BorderFree has been selected in the layout settings.*

Placing a Document on the Document Table

1. Open the document cover. Place the original document facing down on the document table. Make sure that the document is properly aligned.

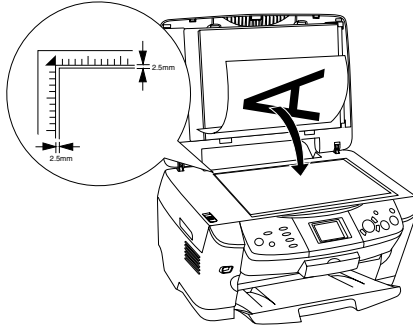

Caution:

Never open the document cover beyond its limit by intention.

Note:

An area of up to 2.5 mm from the edge of the document table glass cannot be scanned.

2. Make sure the reflective document mat is attached to the document cover.
3. Close the document cover gently so that the document does not move.

Note:

To scan the document properly, close the document cover to prevent interference from the external light.

Changing the Copy Layout

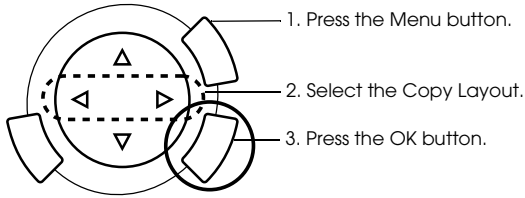

Copy Layout	Feature
Standard*	Standard copy
BorderFree	Copy without margins
Small Margins	Copy with 1.5 mm margins
Repeat-Auto	Copy an image in actual size as many as it fits to the paper you have selected.
Repeat-4 Repeat-9 Repeat-16	Copy an image multiple times on one sheet
Poster-4 Poster-9 Poster-16	Divide an original image to 4, 9, or 16 enlarged copies fit to the paper size you have selected. You can get a poster size image by gluing all of the copies together.
2-up, 4-up	Copy several documents on one sheet
Mirror	Copy a reversed image on an iron-on cool transfer paper
Copy Photo	Copy multiple photos placed together as separate copy.

* Indicates the default setting.

Changing Copy Setting

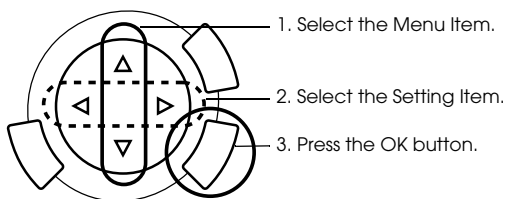

Menu Item	Setting Item	Description
Number of copies	1 to 99	
Reduce/Enlarge	Actual	Copy in the actual size
	10 × 15 cm -> A4 A4 -> 10 × 15 cm 4 × 6 in -> A4 A4 -> 4 × 6 in A4 -> A5 A5 -> A4	Copy in the reduced or enlarged size by selecting the appropriate selection (original document size -> copy result size)
	Auto Fit Page	Copy in the reduced or enlarged size that fits the size of the paper
Zoom In/Out	25% to 400%	
Paper type	Plain, BrightWhite, PQIJ, Photo Paper, Matte, GlossyPhoto, Prem. Glossy, SemiGloss, Iron On See page 15 for detailed settings.	
Paper size	A4, 10 × 15 cm, 4 × 6 in, A5	
Copy Quality	Draft, Text, Photo, Best Photo	
Restoration	Off, On	This setting is only for Copy Photo layout.

Note:

The available menu items, settings and default settings will vary according to the copy layout selected.

Copy Density

The copy density can be changed by nine steps.

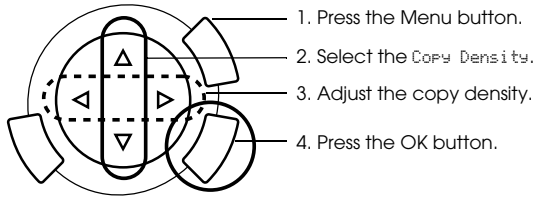

Menu Item	Setting
Copy Density	

Notice and useful tips for copying

Note for copying

- ❑ When you make a copy using a control panel function, a moiré (cross-hatch) pattern may appear on your printout. To eliminate the moiré, change the reduce/enlarge ratio or shift the position of the original document.
- ❑ The copied image may not have exactly the same size as the original.
- ❑ If this product runs out of paper while making copies, be sure to load additional paper as soon as possible. If left without paper for a long period of time, the colors of the first copy made after reloading may not accurately reflect those of the original.
- ❑ If the LCD panel indicates low ink while you are copying, you can either continue making copies until the ink runs out, or stop making copies and then replace the ink cartridge.

When copying in BorderFree or Small Margins layout

Because this layout enlarge the image to a size slightly larger than the paper size, the portion of the image that extends beyond the edge of the paper will not be copied.

When copying in Poster layout

Depending on the original image, the number of divided images may not be 4, 9, or 16 as you selected, because this product reads the entirely white area as blank and the area will not be printed.

Gluing the images together

1. Align the images.
2. Cut the crossover area, and then glue all the images together.

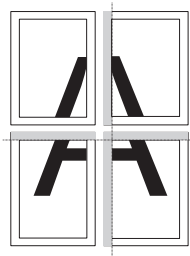

The illustration shows the example of making poster with 4 printouts. The gray area shows the excess area to be cut.



Warning:

Be careful when using edged tools.

When placing a document on the document table

- Keep the document table clean.
- Make sure the document is flat against the glass surface; otherwise the image becomes out of focus.
- Do not leave photographs on the document table for an extended period of time. They may stick to the glass of the document table.
- Do not place heavy objects on top of this product.

When copying in Copy Photo layout

- ❑ You can set 2 photos of the same size at a time.
- ❑ Make sure the document cover is closed.
- ❑ Position each photo at least 10 mm apart from its adjacent photo.

Place each photo vertically as shown in the illustration below.

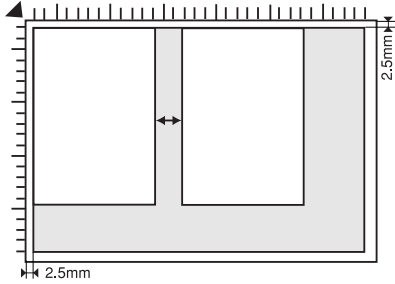

Printing Directly from a Memory Card

Before printing photos from a memory card, you need to do the following:

1. Load a memory card (see “Loading Memory Cards” on page 23) and appropriate paper (see “Loading Paper” on page 13).

Note:

You can only use A4 paper to print an Index Form.

2. Press the Memory Card button.

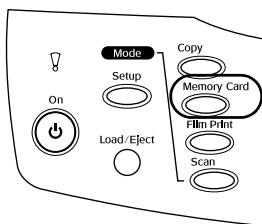

3. Proceed to the appropriate section:

Option	Page to see for details
Basic Print (Printing Basics)	page 26
Custom Print (Printing with Various Settings)	page 27
Zoom Print (Printing Enlarged Images)	page 28
Index Sheet (Printing Using an Index Sheet)	page 30
All Index Print (Printing an Index)	page 32
DPOF (Printing with DPOF Functions)	page 33
P.I.F. All (Printing with PRINT Image Framer)	page 34

Note:

We recommend that you disconnect the USB cable when printing directly from a memory card; if you are printing directly from a memory card with the USB cable connected, the print operation may take longer time.

Loading Memory Cards

Loadable memory card

The types of memory cards are shown below.

Memory Stick	MagicGate Memory Stick	Memory Stick Duo*
SD Card	Memory Stick PRO	miniSD Card*
SmartMedia	MultiMedia Card	xD-Picture Card
CompactFlash	Microdrive	

* An adapter is required.

Note:

The method to use a memory card varies depending on its card type. Be sure to refer to the documentation packaged with your memory card for details.

Available image files

You can use image files that meet the following requirements.

Media format	DCF version 1.0 compliant*
File format	JPEG or TIF format image files**, DOS FAT taken with a DCF version 1.0 compliant digital camera.
Image size	Vertical 120 to 4600 pixels, horizontal 120 to 4600 pixels
Number of files	Up to 999

* DCF stands for the "Design rule for Camera File system" standard, which is set by the Japan Electronics and Information Technology Industries Association (JEITA).

** Supports Exif Version 2.1/2.2.

Note:







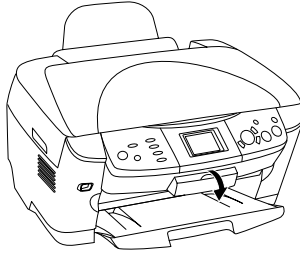



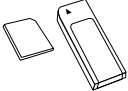

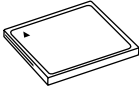

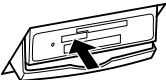
You cannot print images with file name containing double-byte characters.

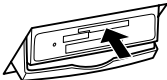
Inserting memory cards

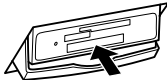
1. Open the memory card slot cover.

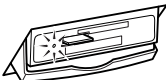

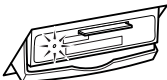
2. Make sure the memory card light beside the memory card slot is off, and then insert a memory card as far as it can go into the appropriate slot.

Memory Stick/ MagicGate Memory Stick/Memory Stick Duo*/Memory Stick PRO/SD Card/miniSD Card*/MultiMedia Card	SmartMedia/ xD-Picture Card	CompactFlash/ Microdrive
		
 	 	 
 	 	 

Note:

You can load only one memory card at a time.

3. Close the memory card slot cover.

**Caution:**

- ❑ *Do not try to squeeze the memory card into the slot. Memory cards cannot be fully inserted into the card slots.*
- ❑ *Incorrect loading of a memory card may damage this product, memory card, or both.*
- ❑ *Keep the memory card slot cover closed while the memory card is loaded, which protects the memory card and the slot from dust and static; otherwise data on the memory card may be lost, or this product may be damaged.*
- ❑ *Depending on the memory card loaded in this product, the static charge on the memory card may cause this product to malfunction.*

Note:

If the memory card is inserted incorrectly, the memory card light does not go on.

Ejecting memory cards

1. Make sure all the printing job is finished and the memory card light is not flashing.
2. Open the memory card slot cover.
3. Eject the memory card by pulling it out straight from the slot.



Caution:

- ❑ Do not remove the memory card or turn off the product while the printing or while the memory card light is flashing. Data on the memory card may be lost.

- ❑ If you are using this product with a computer which has Windows 2000 or XP installed, never turn this product off or disconnect the USB cable with a memory card inserted in this product; this may destroy data on the memory card. See the Reference Guide for detail.

4. Close the memory card slot cover.

Printing Basics

You can print photos to 10 × 15 cm paper without altering any settings.

1. Select **Basic Print** and the appropriate printing option.

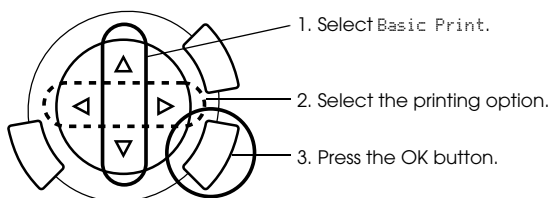

Printing Option	Description
Select Print	Select and print the desired photos.
All Print	Prints all photos stored on a memory card.
Range Print	Select and print a contiguous range of photos.
DPOF	Prints photos with DPOF information. See "Printing with DPOF Functions" on page 33 for instructions.

2. Select the photos you want to print (see "Selecting Photos and Printing Options" on page 36).

3. Press the \diamond Color button to start printing.
4. Press the Cancel button to return to the top menu.

Printing with Various Settings

You can print photos to various sizes and types of paper with the appropriate settings.

1. Select Custom Print and the appropriate printing option.

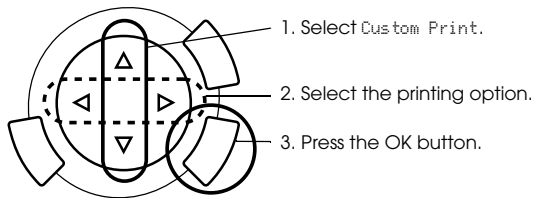

Printing Option	Description
Select Print	Select and print the desired photos.
All Print	Prints all photos stored on a memory card.
Range Print	Select and print a contiguous range of photos.
DPOF	Prints photos with DPOF information. See "Printing with DPOF Functions" on page 33 for instructions.
P.I.F. All	Adds Frames to your photos.

2. Select the photo which you want to print (see "Selecting Photos and Printing Options" on page 36).
3. Change the print setting (see "Changing Print Settings" on page 37).
4. Enter the number of copies by pressing the \blacktriangle / \blacktriangledown buttons.

5. Press the ◊ Color or ◊ B&W button to start printing.
6. Press the Cancel button to return to the top menu.

Printing Enlarged Images

You can enlarge and print your photos.

1. Select Zoom Print.

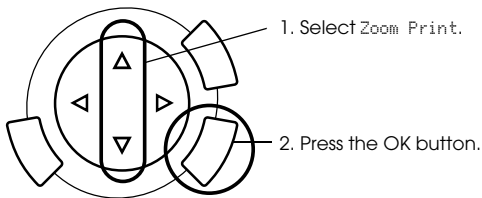

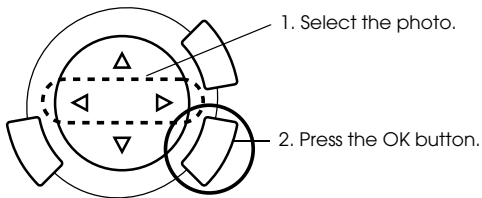

2. Select the photo which you want to print.

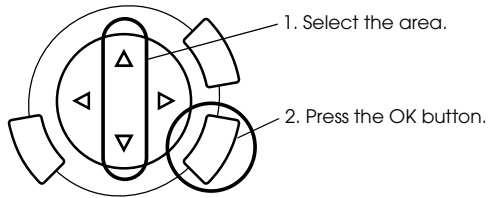

3. Change the print setting (see “Changing Print Settings” on page 37) if necessary.

4. Select the upper left point of the zoom area by moving the  icon.



5. Select the lower right point of the zoom area by moving the  icon.

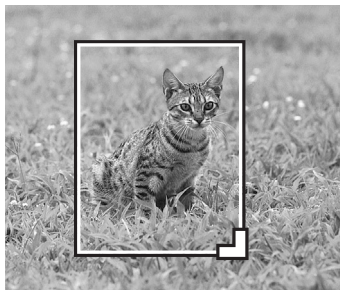
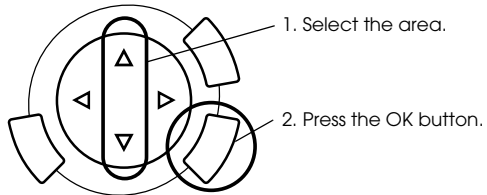

6. Confirm the preview image and press the OK button.

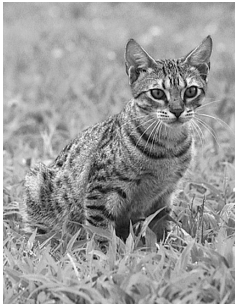

7. Enter the number of copies by pressing the ▲/▼ button.
8. Press the ◊ Color or ◊ B&W button to start printing.
9. Press the Cancel button to return to the top menu.

Printing Using an Index Sheet

Using an Index Sheet is an easy and convenient way to print directly from a memory card. The Index Sheet gives you a thumbnail view of photos stored on the memory card.

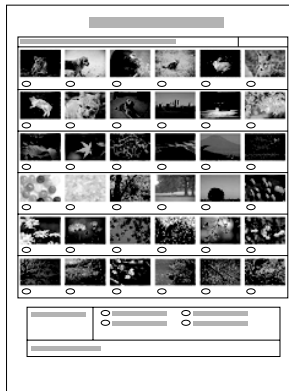

Printing an Index Sheet

1. Press the Memory Card button.
2. Select Index Sheet.

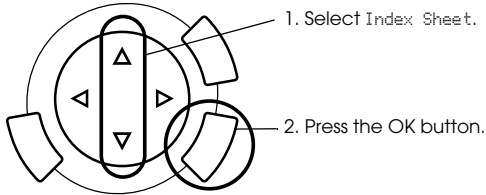

3. Select Print Index by pressing the ▲/▼ button and then press the ◊ Color button to start printing.

Printing photos by filling in the Index Sheet

1. On the Index Sheet, use a dark pen to fill in the circles underneath the photos that you want to print, and specify the paper type.

See the examples below.

Good



Not good



Note:

Complete the Index Form correctly. You cannot change the settings using the control panel.

2. Load paper you have selected on the Index Sheet.
3. Select Scan Index by pressing the ▲/▼ button.

4. Place the Index Sheet with its face down, and its top touching the front left edge of the document table (see “Placing a Document on the Document Table” on page 16).
5. Press the \diamond Color button to start printing.
6. Press the Cancel button to return to the top menu.

Printing an Index

You can print index of all photos stored on a memory card.

1. Select All Index Print.

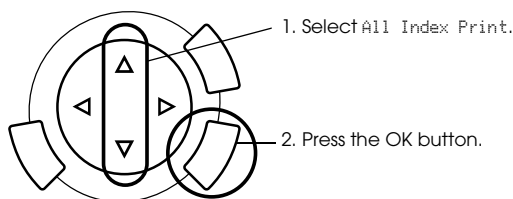

2. Change the Paper Type and Paper Size settings (see “Changing Print Settings” on page 37).

Note:

The number of photos arranged on a single sheet will depend on the size of the paper.

3. Press the \diamond Color button to start printing.
4. Press the Cancel button to return to the top menu.

Printing with DPOF Functions

DPOF (Digital Print Order Format) is an industry-standard print file request format. This product conforms to DPOF version 1.10. DPOF lets you set photo numbers and the number of copies for photos stored on a digital camera, before you start printing. To create DPOF data, you must use a digital camera that supports DPOF. For details on the DPOF settings of your digital camera, see your digital camera's documentation.

Note:

If the memory card contains DPOF settings made on your digital camera, you will only be able to print in color.

1. Select **Basic Print** or **Custom Print** and **DPOF**.

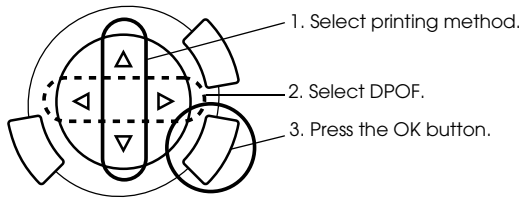

Note:

DPOF appears only if your memory card contains the DPOF data.

2. When you select **Custom Print**, change the print setting (see “Changing Print Settings” on page 37).
3. Press the **Color** or **B&W** button (for **Custom Print** only) to start printing.
4. Press the **Cancel** button to return to the top menu.

Printing with PRINT Image Framer

You can add colorful and creative frames to your favorite photographs. Choose from a variety of ready made frames to add flair and variety to your photographs.

Printing all frame data (P.I.F. All Print)

1. Load a memory card containing PRINT Image Framer data.

Note:

Be sure to properly save the PRINT Image Framer data which named “\EPUDL\AUTOLOAD.USD” to the memory card using the EPSON PRINT Image Framer Tool; otherwise “AUTOLOAD” will not appear on the LCD panel.

2. Select Custom Print and P.I.F. All.

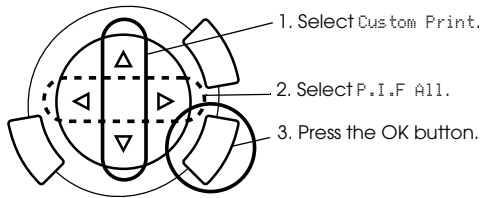

3. Change the Paper Type and Paper Size settings (see “Changing Print Settings” on page 37).
4. Press the \diamond COLOR button.
5. Press the Cancel button to return to the top menu.

Printing photos with PRINT Image Framer

1. Load a memory card containing photo data.
2. Select Custom Print and Select Print.

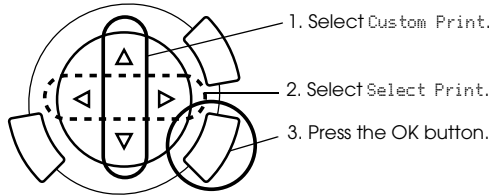

3. Select P.I.F. as the layout in the print settings menu (see “Changing Print Settings” on page 37).

Note:

When you select P.I.F. as the layout, paper size is set automatically.

4. Confirm the layout and number of prints on the LCD panel.
5. Press the \diamond Color button or \diamond B&W button to start printing.
6. Press the Cancel button to return to the top menu.

Selecting Photos and Printing Options

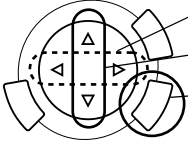
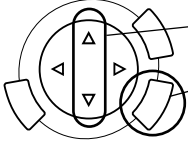
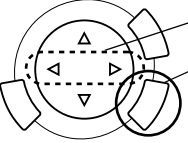
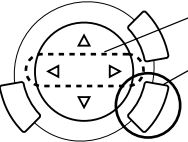
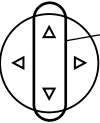
Printing Option	How to Select
Select Print	 <ol style="list-style-type: none"> 1. Select the desired photo. 2. Set the number of prints. 3. Press the OK button (only for Custom Print).
All Print	 <ol style="list-style-type: none"> 1. Set the number of prints for each photo. 2. Press the OK button.
Range Print	 <ol style="list-style-type: none"> 1. Select the first photo. 2. Press the OK button.  <ol style="list-style-type: none"> 3. Select the last photo. 4. Press the OK button. <p>For Basic Print Only</p>  <ol style="list-style-type: none"> 5. Set the number of prints for all photos.

Changing Print Settings

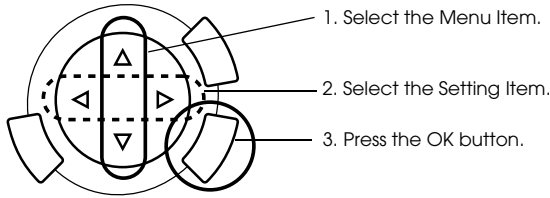

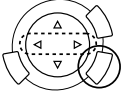
Menu Item	Setting Item	Description
		
Paper type	Plain, BrightWhite, GlossyPhoto, Photo Paper, Prem. Glossy*, SemiGloss, Matte, PQLJ, Iron-on See page 15 for detailed settings.	
Paper size	A4, 10 × 15 cm*, 4 × 6 in	
Layout	BorderFree*	Prints without margin.
	With Border	Print with a 3 mm margin along the top, bottom, and on both sides.
	2-up, 4-up, 8-up, 20-up	Prints multiple photos on one sheet: The size of each photo is adjusted automatically according to the number of photos to print and the size of paper.
	Upper1/2	Prints on upper half part of paper
	P.I.F.	Select this layout when Printing photos with PRINT Image Frammer.
Resolution	Normal, Photo*, Best Photo	
Filter	Off*	Does not print in sepia tone, but in color or gray scale.
	Sepia	Prints in sepia tone.

Menu Item	Setting Item	Description
	P.I.M.*	Prints using the PRINT Image Matching function. If the photo data does not include P.I.M., try printing with PhotoEnhance.
	Exif	Prints using the Exif Print function. It provides you with high-quality printouts.
	Photo Enhance	Prints enhanced images automatically. It requires longer time, but gives better quality.
	None	Prints with no automatic correction.
Small Image	On	Removes digital noise and enhances the resolution.
	Off*	Does not remove digital noise or enhance the resolution.
Brightness	Brightest	Makes printouts very bright.
	Brighter	Makes printouts slightly brighter.
	Standard*	No brightness adjustment
	Darker	Makes printouts slightly darker.
	Darkest	Makes printouts very dark.
Contrast	Super High	Makes contrast of printouts very strong.
	High	Makes contrast of printouts slightly stronger.
	Standard*	No contrast adjustment.
Sharpness	Sharpest	Makes the outline of subjects very sharp.
	Sharper	Makes the outline of subjects slightly sharper.
	Standard*	No sharpness adjustment
	Softer	Makes the outline of subjects slightly softer.
	Softest	Makes the outline of subjects very soft.

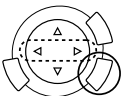
Menu Item 	Setting Item 	Description
Saturation	Most Sat.	Makes printouts very vivid.
	More Sat.	Makes printouts slightly more vivid.
	Standard*	No saturation adjustment
	Less Sat.	Makes printouts slightly duller.
	Least Sat.	Makes printouts very dull.
Date Prints the shooting date.	None*	Prints with no date information.
	yyyy.mm.dd	e.g. 2003. 05. 18
	mmm.dd.yyyy	e.g. Oct. 18. 2003
	dd.mmm.yyyy	e.g. 18. Oct. 2003
Time Prints the shooting time.	None*	Prints with no time information.
	12-hour system	e.g. 10:00
	24-hour system	e.g. 22:00
Print Info.	Off*	Prints with no information.
	On	Prints with information (exposure time/shutter speed, F number, ISO speed rate) in the bottom right area of a printout.
Fit to Frame	On*	Automatically trims the areas of an image that extend beyond the margins of the selected print size. Either the top and bottom, or the left and right areas of photo is trimmed, depending on the aspect ratio of the original photo and the selected print size.
	Off	Does not trim the image.
Bidirectional	On*	Faster (Printing quality is normal.) By turning this function on, you can perform bidirectional printing (printing from right to left and from left to right).
	Off	Slower (Printing quality is fine.)

* Indicates the default setting.

Printing from Film

Before printing photos from films, you need to do the following:

1. Load and set film on the document table (see “Loading and Setting Film on the Document Table” on page 45).
2. Load appropriate paper (see “Loading Paper” on page 13).
3. Press the Film Print button.

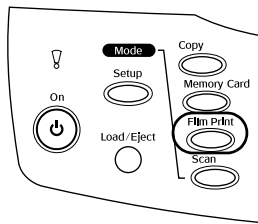

4. Proceed to the appropriate section:

Option	Page to see for details
Basic Print (Printing Basics)	page 41
Custom Print (Printing with various settings)	page 42
Zoom Print (Printing expanded images)	page 43

Printing Basics

You can print photos to 10 x 15 cm paper without altering any settings.

1. Select Basic Print.

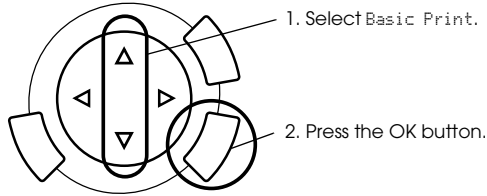

2. Select the film type (see "Selecting the Film Type" on page 44).
3. Select the desired photo and set the number of prints.

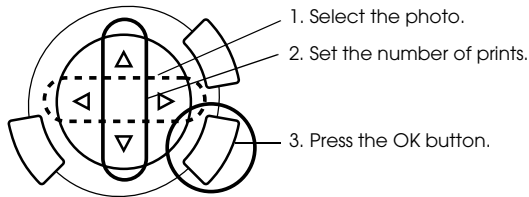

4. Press the \diamond Color or \diamond B&W button to start printing.

Printing with Various Settings

You can print photos to various size and types of paper with the appropriate settings.

1. Select Custom Print.

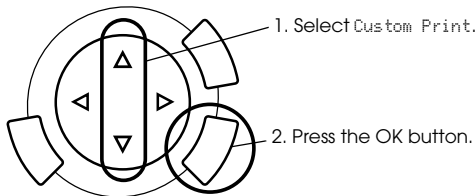

2. Select the film type (see “Selecting the Film Type” on page 44).
3. Select your desired photo and set the number of prints.

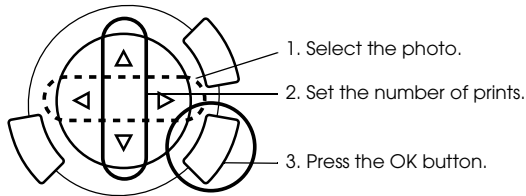

4. Change the print setting (see “Changing Print Settings” on page 44).
5. Press the \diamond Color or \diamond B&W button to start printing.

Printing Enlarged Images





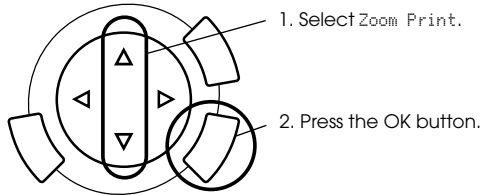

You can enlarge and print photos from the film.

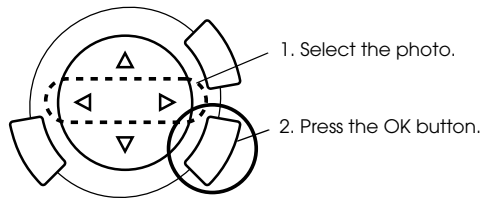
1. Select Zoom Print.



2. Select the film type (see “Selecting the Film Type” on page 44).
3. Select the desired photo.



4. Change the print setting (see “Changing Print Settings” on page 44) if necessary and press the OK button.
5. Select the zoom area by moving the  and  icon (see Step 4 and 5 in “Printing Enlarged Images” on page 28 in Printing Directly from Memory card for details).
6. Confirm the preview image and press the OK button.
7. Enter the number of copies by pressing the /  buttons.
8. Press the  COLOR or  B&W button to start printing.

Selecting the Film Type

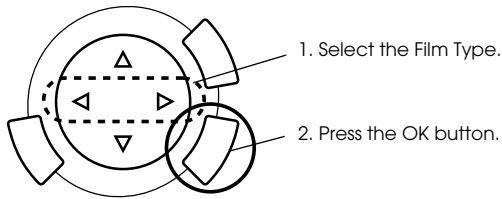

Negative Color Film	Positive Color Film (Strip)
Positive Color Film (Slide)	Negative B&W Film

Changing Print Settings

Menu Item	Setting Item	Description
Paper Type	Plain, BrightWhite, Glossy Photo, Photo Paper, Prem. Glossy*, SemiGloss, Matte, PQIJ See page 15 for detailed settings.	
Paper Size	A4, 10 × 15 cm*, 4 × 6 in	
Resolution	Photo, Best Photo*	
Restoration	On	Restores faded colors on film and in photos. Note: This setting has no effect when Negative B&W Film is selected as the Film Type.
	Off*	Leaves faded colors on film and in photos as they are.
Layout	BorderFree*	Prints without margin.
	With Border	Prints with margin.

* Indicates the default setting.

Loading and Setting Film on the Document Table



Caution:

Hold the film at its edges, or else use gloves. Touching the film surface with bare hands can leave fingerprints or other traces on the film.

Note:

Wipe the inside of the document cover and the document table before scanning transparencies.

1. Make sure the document cover's cable is connected to the TPU interface connector and open the document cover.

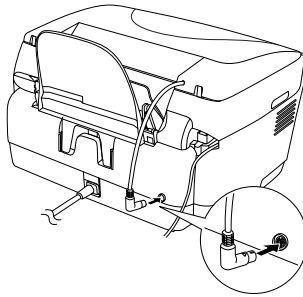

2. Remove the reflective document mat gently along the document cover.

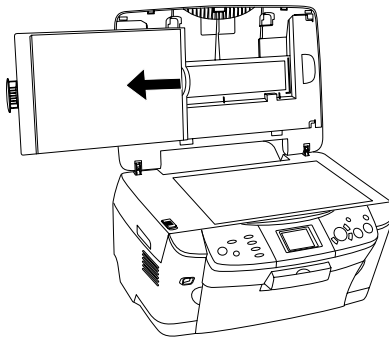

Note:

Make sure to hold the document cover with both hands.

3. Load the transparency into the film holder and position it on the document table.

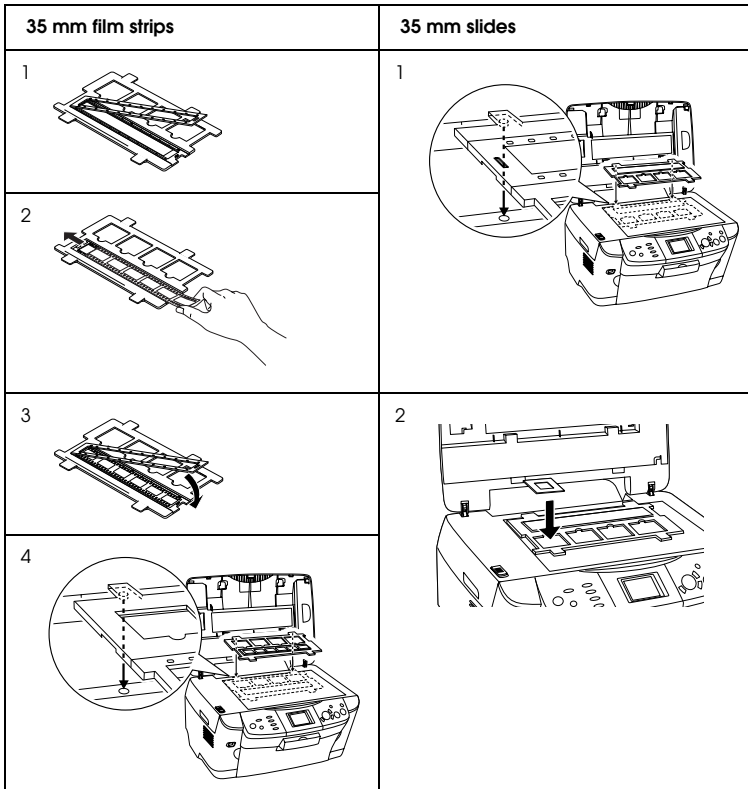

Note:

- ❑ Place the film holder on the center of the document table.
- ❑ The base side of the film is the side where the film maker's name and film ID numbers can be read correctly. Also, when you look at an image on the film from the base side, the image should appear normally, not as the reverse of it.
- ❑ Set the film correctly in the film holder and position the film holder properly on the document table.
- ❑ Do not press the glass of the document table with too much force.

4. Close the document cover.

Note:

- ❑ *Make sure the document cover is completely closed; otherwise you cannot obtain proper colored images.*
- ❑ *A newton ring (ring-shaped stripes pattern) may appear in the scanned image. To remove the newton ring, set the film with the base side facing up. See the Reference Guide for detail.*
- ❑ *When you are not using the film holder, you can store it inside the document cover. See “Storing the film holder” on page 47 for details.*

Storing the film holder

When not using the film holder, you can store it inside the document cover.

1. Open the document cover.
2. Slide the film holder into the document cover.

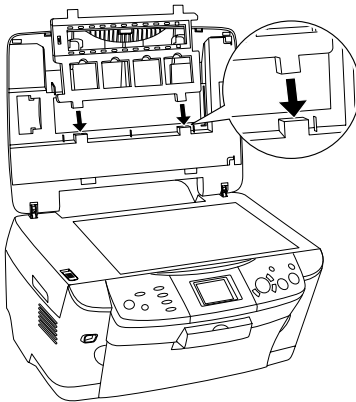

3. Insert the reflective document mat.

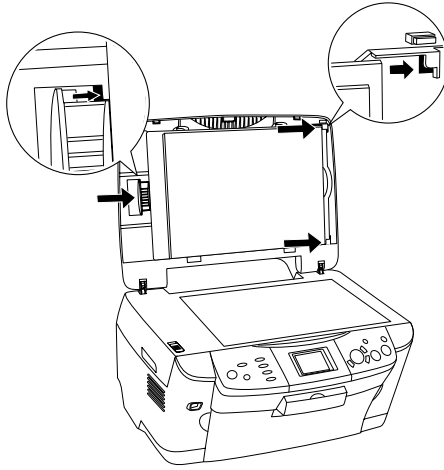

Note:

Make sure to hold the document cover with both hands.

4. Close the document cover.

Scanning by Using the LCD Panel and Buttons

This product allows you to scan images to a memory card, computer, or e-mail (available on a computer), and then edit them to meet your needs.

Note:

- ❑ To scan images to a computer or e-mail, see the Reference Guide.
- ❑ The scanned images are saved in JPEG format to the “epscan” folder which is automatically created when you scan to a memory card.

Scanning and Saving a reflective document to a Memory Card

1. Load a memory card (see “Loading Memory Cards” on page 23).
2. Press the SCAN button to enter the Scan Mode.

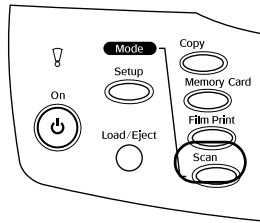

3. Select Scan to Memory Card.

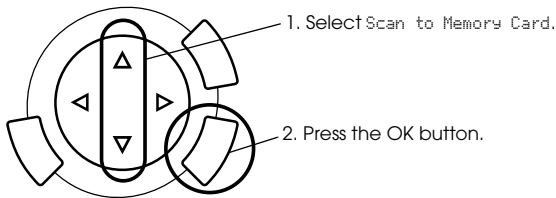

4. Select the appropriate scan settings.

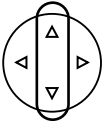
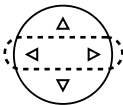
Setting	Selection
	
Scan area	Auto cropping*, Max area
Document Type	Text, Graphics*
Quality	Normal, Photo, Fine

* Indicates the default setting.

Quality affects the file size of images as follows:

Document type	Quality	Scanning resolution	File size**
Text	Normal*	200 x 200 dpi	350 KB
	Fine		650 KB
Graphic	Fine	300 x 300 dpi	650 KB
	Photo*		3.0 MB

* Indicates the default setting.

** A4, color document.

- Place an original document on the document table (see “Placing a Document on the Document Table” on page 16).
- Press the  COLOR button to start scanning.
- Confirm that the images were saved correctly and press the OK button.



Caution:

Never open the scanner unit while scanning or copying; otherwise, you may damage this product.

Scanning and Saving a film to a Memory Card

1. Load a memory card (see “Loading Memory Cards” on page 23).
2. Press the Film Print button to enter the Film Print Mode.
3. Select Scan to Memory Card.

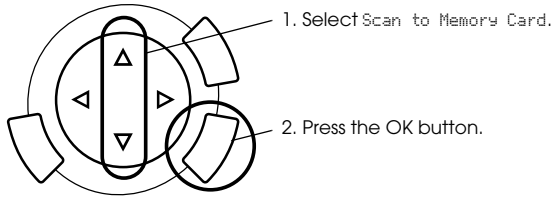

4. Select the film type (see “Selecting the Film Type” on page 44).
5. Select the desired photo and set the number of prints.

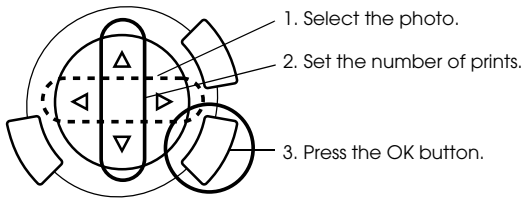

6. Select the Quality option by pressing the ◀/▶ buttons.

Scan quality affects the file size of the images. Be sure to leave enough space according to the following table:

Quality	File size
Fine	500 KB
Photo	4.8 MB

7. Press the ◊ Color or ◊ B&W button to start scanning.
8. Confirm that the images were saved correctly and press the OK button.

Formatting a memory card

If the message prompts you to format the memory card appears on the LCD panel, press the OK button to format the memory card.



Caution:

All data on a memory card is deleted when you format the memory card.

Cancelling the format

Press the Cancel button to cancel format, and then exchange it with a formatted one.

Using Additional Features

Printing Directly from a Digital Camera

You can use this feature with digital cameras which support the USB DIRECT-PRINT or PictBridge functions. For more details on the operation of the digital camera, refer to its manual.

1. Use a USB cable to connect the digital camera to this product.

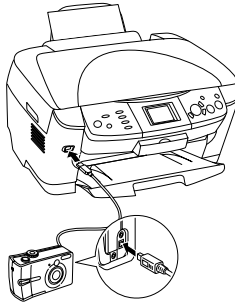

Note:

- ❑ Do not print from the computer or from a memory card inserted in the memory card slot before or while a digital camera is connected to this product.
- ❑ Do not backup before or while a digital camera is connected to this product.
- ❑ Make sure that no error has occurred before a digital camera is connected to this product.

2. Press the Setup button and select the Direct Print image set using the ▲/▼ button, then press the OK button.

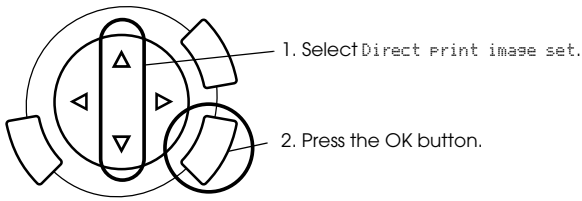

3. Adjust the settings on the digital camera (e.g. paper size, paper type, and layout).
4. Change the print setting (see “Changing Print Settings” on page 37) if necessary.
5. Print from the digital camera.

Saving the Images Stored in the Memory Card to an External Device (Backup)

1. Make sure that this product and the external device are off.
2. Use a USB cable to connect the external device to this product and turn on both of them.
3. Load a memory card containing the data and insert a media to the external device.

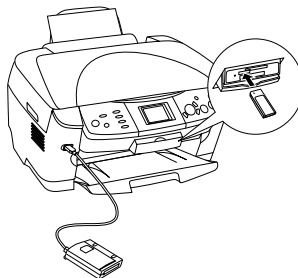

4. Press the Memory Card button.
5. Select **BACKUP** by using the ▲/▼ button, then press the OK button.

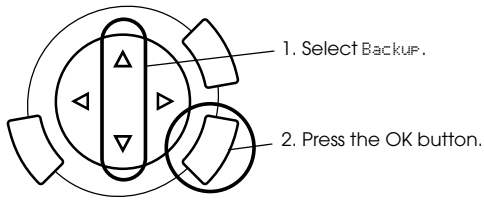

6. Confirm the messages on the LCD panel, then press the OK button.
7. Press the OK button again to start the backup.

Replacing Ink Cartridges

Ink Cartridges

You can use the following cartridges with this product.

Black ink cartridge	Black	T0481
Color ink cartridge	Cyan Magenta Yellow Light cyan Light magenta	T0482 T0483 T0484 T0485 T0486



Caution:

Epson recommends the use of genuine Epson ink cartridges. Epson will not warranty any damage caused by the use of other products.

Checking the Ink Level

1. Press the Setup button.
2. Select Ink Levels. The amount of ink appears.

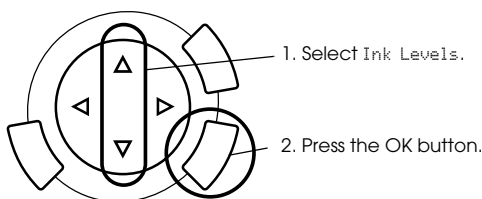

3. If you want to replace the ink cartridge, go on to the next section. To return to the previous display without replacing the ink cartridge, press the OK button.



Caution:

Leave the used ink cartridge installed until just before replacement; otherwise, ink remaining in the print head nozzles may dry out.

Precautions on Ink Cartridge Replacement

- ❑ If you need to remove an ink cartridge temporarily from this product, be sure to protect the ink supply area of the ink cartridge from dirt and dust. Store the ink cartridge in the same environment as this product. When storing the cartridge, be sure that its label identifying the color of the ink cartridge is facing upward. Do not store ink cartridges upside down.
- ❑ The valve in the ink supply port is designed to contain any excess ink that may be released. However, careful handling is recommended. Do not touch the supply port of the ink cartridge or its surrounding area.
- ❑ This product uses ink cartridges equipped with an IC chip. The IC chip accurately monitors the amount of ink used by each cartridge, so even if a cartridge is removed and then later inserted again, all of its ink can be used. However, some ink is consumed each time the cartridge is inserted because this product automatically checks its reliability.
- ❑ When an ink cartridge becomes empty, you cannot continue copying even if the other cartridge still contains ink. Before copying, replace the empty cartridge.
- ❑ In addition to being used in document copying, ink is also consumed in the following operations: print head cleaning, self-cleaning cycle performed when this product is turned on, and ink charging when an ink cartridge is installed in this product.
- ❑ Do not refill the ink cartridges. This product calculates the amount of ink remaining using an IC chip built into an ink cartridge. Even if the cartridge is refilled, the amount of ink remaining is not recalculated by the IC chip and therefore the amount of ink available for use does not change.
- ❑ After an ink cartridge is replaced, if the ink is low it may become empty. When a message appears to indicate the ink is low, prepare a new ink cartridge.

Replacing an Ink Cartridge

Follow the steps below to replace ink cartridges.

Note:

Before replacing an ink cartridge, read "Precautions on Ink Cartridge Replacement" on page 57 and "When handling ink cartridges" on page 7.

1. **When the ink is empty:**

Refer to the LCD panel message to see which ink cartridge is empty, and then press the OK button.

When the ink is low:

Press the Setup button and select Ink cartridge by pressing the ▲/▼ button, then press the OK button. Confirm the messages on the LCD panel and press the OK button to start the ink cartridge replacement.

The ink cartridges move to the replacement position.

2. Make sure that the document cover is closed, and then open the scanner unit.

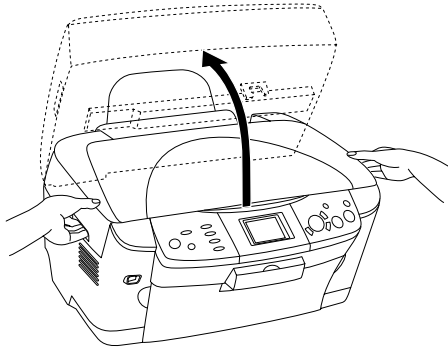

**Caution:**

- ❑ Do not open the scanner unit when the document cover is still open.
- ❑ Do not move the print head by hand. Doing so may damage this product.
- ❑ Do not start replacing an ink cartridge before the print head stops.

3. Open the cartridge cover.

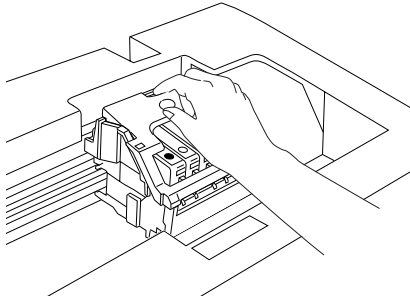

4. Remove an ink cartridge from its package.

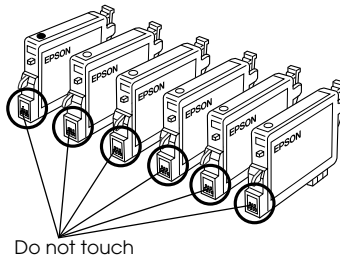

5. Pinch the sides of the ink cartridge that you want to replace. Lift the cartridge out of this product and dispose of it properly. Do not take the used cartridge apart or try to refill it.

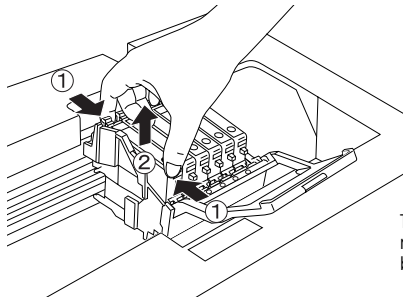

The illustration shows replacement of the black ink cartridge.



Warning:

Be careful when you handle the used ink cartridges. There may be some ink around the ink supply port. If ink gets on your skin, wash the area thoroughly with soap and water. If ink gets into your eyes, flush them immediately with water. If discomfort or vision problems remain after a thorough flushing, see a doctor immediately.



Caution:

Leave the used ink cartridge installed until just before replacement; otherwise, ink remaining in the print head nozzles may dry out.

6. Install the new ink cartridge straight into the cartridge holder, and then press the top of the cartridge until it clicks into place.

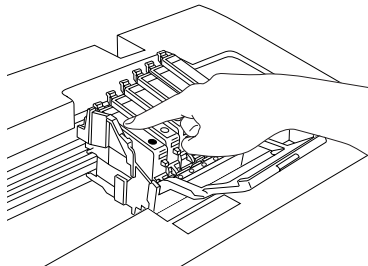

If you need to replace the other ink cartridge, repeat steps 4 to 6.

7. Close the cartridge cover.

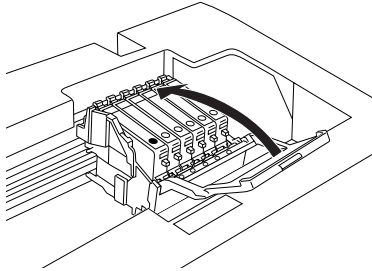

Note:

If you find it difficult to close the cartridge cover, see step 6 to make sure the ink cartridge has been installed correctly.

8. Close the scanner unit.

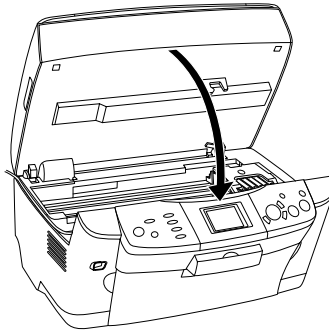

The print head moves to its home position, and ink charging begins.

9. When Ink cartridge replacement completed appears on the LCD panel, press the OK button.



Caution:

Never turn off this product while ink charging in progress; Otherwise, this will cause incomplete charging of the ink.

Note:

If you install a used ink cartridge with ink level already low, it may become empty right after the replacement. In this case, replace the ink cartridge with a new one.

Summary of Panel Setting

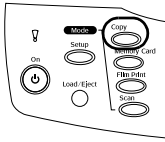

Copy Mode

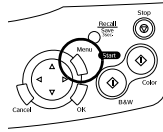

Copy Setting

Number of copies	1 to 99
Reduce/Enlarge	Actual, Auto Fit Page 10 x 15 cm -> A4, A4 -> 10 x 15 cm, 4 x 6 in -> A4, A4 -> 4 x 6 in, A4 -> A5, A5 -> A4
Zoom In/Out	25% to 400%
Paper Type	Plain, BrightWhite, GlossyPhoto, Photo Paper, Prem. Glossy, SemiGloss, Matte, PQLJ, Iron On
Paper Size	A4, 10 x 15 cm, 4 x 6 in, A5
Copy Quality	Draft, Text, Photo, Best Photo
Restoration	Off, On

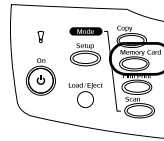

Copy Layout	Standard, BorderFree, Small Margins, Repeat-Auto, Repeat-4, Repeat-9, Repeat-16, Poster-4, Poster-9, Poster-16, 2-up, 4-up, Mirror, Copy Photo
Copy Density	



Memory Card Mode

Basic Print	Select Print, All Print, Range Print, DPOF
Custom Print	Select Print, All Print, Range Print, DPOF, P.I.F. All
Index Sheet	Print Index, Scan Index
Zoom Print	/
All Index Print	
Backup	

Print Setting for Memory Card Mode

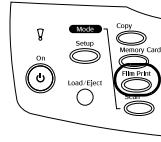

	
Paper Type	Plain, BrightWhite, GlossyPhoto, Photo Paper, Prem. Glossy, SemiGloss, Matte, PQJ, Iron On
Paper Size	A4, 10 × 15 cm, 4 × 6 in
Layout	BorderFree, 2-up, 4-up, 8-up, 20-up, Upper1/2, With Border, P.I.F, Greeting
Resolution	Photo, Normal, Best Photo
Filter	Off, Sepia
Auto Correct	P.I.M., Exif, PhotoEnhance, None
Small Image	Off, On
Brightness	Brightest, Brighter, Standard, Darker, Darkest
Contrast	Super High, High, Standard
Sharpness	Sharpest, Sharper, Standard, Softer, Softest
Saturation	Most Sat., More Sat., Standard, Less Sat., Least Sat.
Date	None, yyyy.mm.dd, mmm.dd.yyyy, dd.mmm.yyyy
Time	None, 12-hour system, 24-hour system
Print Info.	Off, On
Fit to Frame	Off, On
Bidirectional	Off, On



Film Print Mode



Basic Print
Custom Print
Zoom Print
Scan to Memory Card

Print Settings for Film Print Mode

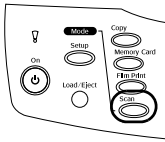
	
Film Type	Negative color Film, Positive Color Film (Strip), Positive Color Film (Slide), Negative B&W Film
Paper Type	Plain, BrightWhite, GlossyPhoto, Photo Paper, Prem. Glossy, SemiGloss, Matte, PQJ
Paper Size	A4, 10 × 15 cm, 4 × 6 in
Quality	Photo, BestPhoto
Restoration	Off, On
Layout	BorderFree, With Border

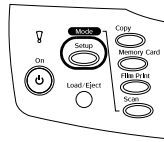

Scan Mode



Setup Mode

Scan to Memory Card
Scan to PC
Scan to Email

LCD Contrast Adjustment
Ink Levels
Nozzle Check
Head cleaning
Ink Cartridge
Head Alignment
Language
Restore to Factory Settings
BT Printer ID set
BT Connectivity mode
BT encryption
BT PIN code set
BT Device address
Direct print image set
Direct print document set

Scan Settings

Scan area	Auto cropping, Max area
Document Type	Text, Graphic
Quality	Normal, Photo, Fine