

EPSON STYLUS™ COLOR 740

DOS User's Guide

Installing the Printer Driver for DOS Programs	2
Using Built-in Fonts and Character Tables	3
Troubleshooting and Maintenance	6
Running a Printer Operation Check	6
Problems and Solutions	9
Ink Cartridge Problems	15
Cleaning the Print Heads	17
Aligning the Print Head	18
Cleaning the Printer	19
Transporting the Printer	20
Character Tables	21
International character sets	30
Characters available with ESC (^ command	31

Installing the Printer Driver for DOS Programs

Most DOS software programs include a driver for EPSON ESC/P 2™ printers, and require you to select the printer name from a list to install the printer driver. To take advantage of your printer's advanced built-in scalable fonts and graphics handling, you need to select an appropriate driver.

If your printer is not included in the list, contact your software manufacturer to obtain updated software.

If the manufacturer does not have an updated printer driver for your printer, select an alternative printer name from those below, starting from the top.

When printing black only:

- LQ-870/1170
- LQ-570 (+)/1070(+)
- SQ-870/1070
- LQ-850
- LQ-500

When printing black and color:

- EPSON Stylus PRO
- EPSON Stylus COLOR 500
- EPSON Stylus COLOR II
- LQ-860
- LQ-2550

Note:

The drivers for the printers listed above do not provide all EPSON STYLUS COLOR 740 features, such as 720-dpi printing, 1440-dpi printing and MicroWeave.

DOS software varies greatly. See the printing section of your software manual for information on accessing the printer driver settings.

Using Built-in Fonts and Character Tables

Your printer has eight built-in fonts and 11 character tables (27 character tables in certain countries) that you can select using the printer's default-setting mode as described below. The settings you choose take effect each time you turn on the printer. Available fonts are listed in the next section. For available character tables, see "Character Tables" on page 21.

Note:

Font and character table selections you make with your software override the settings you make using the default-setting mode. For best results, use your software to make these settings.

To change the default font or character table, follow these steps:

1. Make sure the printer is turned off and paper is loaded in the sheet feeder.



Note:

Use paper at least A4 (210 mm/8.27 inches) size or wider. Otherwise, the print heads will spray ink directly onto the platen, which could mar future printouts.

2. Hold down the  cleaning button and turn on the printer to enter the default-setting mode.

The printer loads a sheet of paper and prints a brief summary and instructions. It instructs you to select the language that you want messages printed in (English, French, German, Italian, or Spanish).

3. Press the  cleaning button until the following lights indicate the language of your choice:

Language			
English	■	□	□
French	□	■	□
German	■	■	□
Italian	□	□	■
Spanish	■	□	■

■ = On, □ = Off

4. Press the  load/eject button to print the current default font and character table, as well as the next instructions in the language you selected. The printed instructions list all of the fonts and character tables you can select and show you how the control panel lights appear for each selection. Use the instruction sheets to change the settings from the control panel.
5. After making your changes, exit the default-setting mode by turning off the printer.

Note:

- *You may exit the default-setting mode any time by turning off the printer. Any changes you have made remain in effect until you change them again.*
- *If you want to check the current default font and character table, enter the default-setting mode again and print the current settings. The current settings are indicated with arrows.*

Fonts

Your printer has eight built-in character fonts including two EPSON fonts: EPSON Roman T and EPSON Sans Serif H.

(Roman T is similar to the Times™ font; Sans Serif H is similar to Helvetica™ .)

The table below shows the available fonts.

Fonts	Sample
EPSON Courier	
EPSON Roman T	
EPSON Sans Serif H	
EPSON Roman	
EPSON Sans Serif	
EPSON Prestige	
EPSON Script	
Draft	

Note:

- Roman T and Sans Serif H fonts are available in proportionally spaced fonts only.*

- Some of the character tables might not be able to print with EPSON Roman T and EPSON Sans Serif H fonts. In these cases, selected character tables are printed with EPSON Roman.*

Scalable fonts

The size of the Roman, Sans Serif, Roman T, and Sans Serif H fonts can be selected from 8 to 32 points in 2-point increments through your software or by sending an ESC/P 2™ command. See the documentation that came with your software for information on selecting the size of scalable fonts.

EPSON
Roman

EPSON
Roman T

scalable sample

EPSON
Sans Serif

EPSON
Sans Serif H

Troubleshooting and Maintenance

This section describes what you can do if you are having problems printing. See also “Troubleshooting and Maintenance” in your *Setup & Daily Use* manual.

Running a Printer Operation Check

Performing a printer operation check can help you determine whether the problem comes from the printer or the computer.

To print a printer operation check page, follow these steps:

1. Make sure both the printer and computer are turned off.

2. Unlock the wire clips on both sides of the interface connector, and remove the ground connector if necessary. Then disconnect the cable from the printer's interface connector.

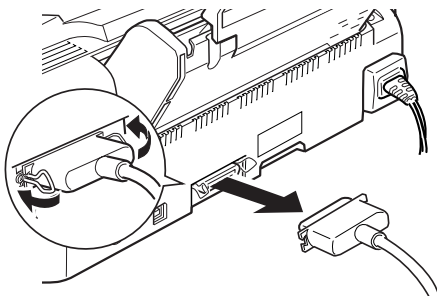

3. Make sure that paper is loaded in the sheet feeder.



Caution:

Use paper at least 210 mm (8.27 inches) wide; for example, A4 size paper loaded short edge first. Otherwise, the print head will spray ink directly onto the platen during the operation check and smear any documents you print afterwards.

4. Hold down the  load/eject button and press the  power button to turn on the printer. Then release both buttons.

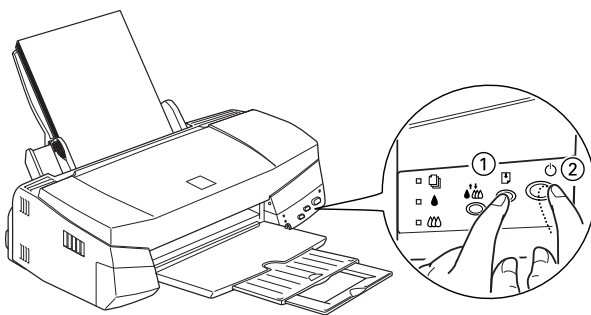

The printer prints an operation check page including the version of your printer's ROM, the ink counter code, the current code page, and a nozzle check pattern. Here is a typical printout:

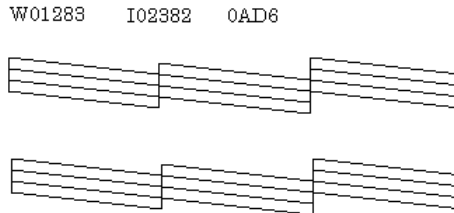

The above sample is in black and white, but the actual test prints in color (CMYK).

5. Press the  power button to turn off the printer after it finishes printing the operation check page.
 - If the operation check page results appear as shown in step 4, the printer itself is all right and the problem probably lies in the printer software settings, application settings, the interface cable (be sure to use a shielded cable), or the computer itself.
 - If the operation check page does not print satisfactorily, for example, if any segment of the printed lines is missing, there is a problem with the printer. This could be a clogged ink nozzle or a misaligned print head.

Problems and Solutions



Most printer problems have simple solutions. Define the problem from those below and apply the recommended solutions.

Print quality problems

If you want to improve print quality, see the following problems and solutions.

Horizontal banding

Try one or more of these solutions:

- Make sure the printable side of the paper is face up in the sheet feeder when loading paper.
- Clean the print heads to clear clogged ink nozzles. See “Cleaning the Print Heads” on page 17.
- Check the  and  ink out lights. If a light is flashing, replace an ink cartridge. See “Replacing an Ink Cartridge” in your *Setup & Daily Use* manual.

Vertical misalignment or banding

Try one or more of these solutions:

- Clean the print heads to clear clogged ink nozzles. See “Cleaning the Print Heads” on page 17.
- Run the Print Head Alignment utility. See “Aligning the Print Head” on page 18.



Incorrect or missing colors

Try one or more of these solutions:

- Make sure the printable side of the paper is face up in the sheet feeder when loading paper.
- Clean the print heads. See “Cleaning the Print Heads” on page 17. If colors are still incorrect or missing, replace the ink cartridge.

Faint printouts or gaps

Try one or more of these solutions:

- ❑ Clean the print heads to clear clogged ink nozzles. See “Cleaning the Print Heads” on page 17.
- ❑ Make sure your paper is not damaged, dirty, or old.
- ❑ Check the  and  ink out lights. If a light is flashing, replace an ink cartridge. See “Replacing an Ink Cartridge” in your *Setup & Daily Use* manual.

Blurry or smeared printouts

Try one or more of these solutions:

- ❑ If you’re printing on thick media, such as envelopes or cards, set the adjust lever to the “+” position, and make sure the Media Type setting is set correctly in your printer driver.
- ❑ Make sure the paper is dry and the printable side is face up.
- ❑ If you’re printing on glossy media or transparencies, place a support sheet (or a piece of plain paper) beneath the stack, or load one sheet at a time.
- ❑ Ink may have leaked inside the printer; wipe the inside of the printer as shown below with a soft, clean cloth.

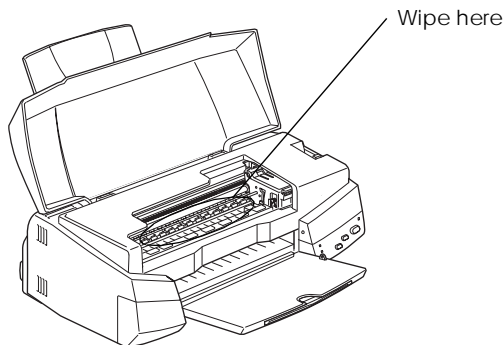

- ❑ Clean the print heads. See “Cleaning the Print Heads” on page 17.
- ❑ Run the Print Head Alignment utility. See “Aligning the Print Head” on page 18.

Printer does not print

If any of the following problems have occurred, see the solutions given below.

All lights are off

- ❑ Press the  power button and make sure the printer is on.
- ❑ Turn off the printer and make sure the power cord is plugged in securely.
- ❑ Make sure the power outlet is working and is not controlled by a wall switch or timer.

Lights came on and then went out

The printer’s voltage may not match the outlet rating. Turn off the printer and unplug it immediately. Then, check the printer labels.

If the voltage doesn’t match, **DO NOT PLUG YOUR PRINTER BACK IN.** See “Where to Get Help” in your *Setup & Daily Use* manual.

Only the power light is on

Try one or more of these solutions:



- ❑ Turn off the printer and computer. Make sure the printer’s interface cable is plugged in securely.
- ❑ Make sure there’s no packing material in the printer.
- ❑ Turn off the printer and computer and disconnect the printer’s interface cable. Then print an operation check page. See “Running a Printer Operation Check” on page 6.
- ❑ If it prints, make sure the printer software and your application software is installed correctly.

Note:





If you're trying to print a large image, your computer may not have enough memory to print.

- ❑ If the above doesn't work, replace the ink cartridges. See "Replacing an Ink Cartridge" in your *Setup & Daily Use* manual.

Paper out light is flashing or on

- ❑ If the  paper out light is flashing, remove the jammed paper.
- ❑ If the  paper out light is on, load more paper in the sheet feeder.

One of the ink out lights is flashing or on

- ❑ If the  or  ink out light is flashing, ink is low. Prepare a replacement cartridge.
- ❑ If the  or  light is on, ink is out. Replace the corresponding cartridge. See "Replacing an Ink Cartridge" in your *Setup & Daily Use* manual.

All lights are flashing

Follow these steps:

1. Remove any paper in the printer.
2. Turn the printer off, wait a few seconds, and then turn it on again.
3. If the lights still flash, turn the printer off and check the inside of the printer for any foreign objects or pieces the paper. Remove all foreign objects and paper, then turn on the printer again.
4. If the lights still flash, contact EPSON. See "Where to Get Help" in your *Setup & Daily Use* manual.

Paper Doesn't Feed Correctly

If any of the following problems have occurred, see the solutions given below.

Paper doesn't feed

Remove the stack of paper and check that:

- The paper isn't curled or creased.
- The paper isn't too old. See the instructions that came with the paper for more information.
- The paper isn't loaded above the arrow on the left edge guide.
- The paper isn't jammed inside. If it is, remove the jammed paper.

Multiple pages feed

Remove the stack of paper and:

- Make sure the paper is not too thin.
- Fan the edges of the stack to separate the sheets, then reload the paper.

The paper jams

Turn off your printer, open the cover, and remove all the paper from inside, including any torn pieces. Then load paper again.

If the paper jams frequently, make sure you:

- Use smooth, high-quality paper, loaded with the printable side up.
- Fan the stack before loading it.
- Don't load paper above the arrow mark on the left edge guide.
- Adjust the left edge guide to fit your paper.

Paper isn't ejected fully or is wrinkled

Try one or more of these solutions:

- If the paper doesn't eject fully, press the  Load/Eject button. Also check the paper size setting in your application or printer driver.
- If the paper is wrinkled when it comes out, it may be damp or too thin. Load a new stack.

Note:

Store any unused paper in its original package in a dry area.

Printouts are not what you expected

If any of the following problems have occurred, see the solutions given below.

Incorrect or garbled characters

Turn off the printer and computer. Make sure the printer's interface cable is plugged in securely.

Incorrect margins

Check the margin settings in your application software.

Blank pages print

Clean the print heads to clear the clogged nozzles. See "Cleaning the Print Heads" on page 17.

After trying one or more of these solutions, run another printer operation check.



Printing is too slow



Try one or more of these solutions:

- Don't run too many applications at the same time. Close any applications you are not currently using.
- Delete unnecessary files to make room on your hard disk drive.

Ink Cartridge Problems



If output quality does not improve even after cleaning and aligning the print head, you may need to replace one or both of the ink cartridges.

To replace an ink cartridge before the  or  ink out light flashes, follow these steps.

If the  or  ink out light is flashing or is on, replace the empty ink cartridge as described in “Replacing the Ink Cartridge” in your *Setup & Daily Use* manual.



Caution:

- Once you remove an ink cartridge, it becomes unusable and cannot be reinstalled even if ink remains.*
 - Leave the old cartridge installed in the printer until you are ready to replace it with a new one.*
1. Make sure the printer is on. The  power light should be on, but not flashing.
 2. Lower the output tray; then open the printer cover.
 3. Hold down the  load/eject button for three seconds; the print head moves to the replace position. The  power light begins flashing.

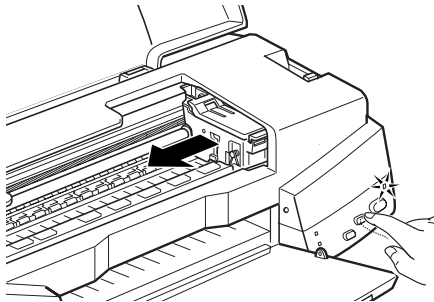

4. Lift the appropriate ink cartridge clamp. Dispose of the empty ink cartridge properly.
5. Remove the yellow tape seal from the new cartridge and lower the cartridge into the cartridge holder.
6. Press the ink cartridge clamp down until it locks in place.





Caution:

Once you install the cartridges, do not open their clamps again until you replace the ink cartridges. Otherwise, the cartridges may become unusable.

7. Press the  load/eject button again. The printer moves the print head back to its home position and charges ink in the system.





Caution:

The  power light continues to flash while the printer performs the ink charging operation. Never turn off the printer while the  power light is flashing. Doing so can result in incomplete charging of ink.



Cleaning the Print Heads



If print quality diminishes, use the printer's built-in print head cleaning cycle to ensure that the nozzles are delivering ink properly.

To avoid wasting ink, clean the print head only if print quality declines.

1. Make sure that the printer is on and the  and  ink out lights are off.

Note:

The print head cannot be cleaned if the  or  ink out light is flashing or on. Replace the ink cartridges as needed before proceeding.

2. Press the  cleaning button for three seconds. The  power light begins flashing, and the printer ejects any paper in the paper path and starts cleaning the print head. This operation takes about two minutes to complete.



Caution:

Never turn off the printer while the  power light is flashing. Doing so may damage the printer.

3. After the  power light stops flashing, print a few lines to confirm that the head is clean and reset the cleaning cycle.

If you entered the print head cleaning mode while the printer was printing a document, the printer feeds paper and resumes printing automatically.

If the print quality does not improve, repeat step 2, then print a few lines to check the output. If print quality hasn't improved after repeating this procedure four or five times, see "Problems and Solutions" on page 9. If the print quality still has not improved after following the recommendations listed in troubleshooting section, contact your dealer.

Aligning the Print Head

If you find that the printed image is fuzzy or the vertical lines in your printout are not properly aligned, you may need to align the print head with the EPSON Print Head Alignment Utility. This utility aligns the print head to print images clearly. You may need to align the print head when you transport the printer or move it to a different place.

To install this utility on your hard drive, insert the EPSON Printer Software CD-ROM into your CD-ROM drive and then type D:\SETUP at the DOS prompt. (If your CD-ROM driver has a different drive letter, or if you are using the floppy version, substitute the appropriate letter for D:\.) Follow the directions on the screen. After running the setup program, change to the drive and directory that contains the utility (or set the path to the directory). Then type EPCALIB2 and press Enter. The following window appears:



Make sure your printer is selected. Click Next, then follow the directions on the screen.

Cleaning the Printer

To keep your printer operating at its best, you should clean it thoroughly several times a year.

1. Make sure the printer is turned off and all the printer's lights are off. Then unplug the power cord.
2. Remove any paper from the sheet feeder.
3. Use a soft brush to carefully clean away all dust and dirt.
4. If the outer case or the inside of the sheet feeder is dirty, clean it with a soft, clean cloth dampened with mild detergent. Keep the printer cover closed to prevent water from getting inside.
5. If the inside of the printer is accidentally soiled with ink, wipe it out with a damp cloth.



Warning:

Be careful not to touch the gears inside the printer.



Caution:

- Never use alcohols or thinners to clean the printer; these chemicals can damage the components as well as the case.*
- Be careful not to get water on the printer mechanism or electronic components.*
- Do not use a hard or abrasive brush.*
- Do not spray the inside of the printer with lubricants; unsuitable oils can damage the mechanism. Contact your dealer or a qualified service person if lubrication is needed.*

Transporting the Printer

If you need to transport your printer a significant distance, carefully repack it using the original box and packing materials as follows:

1. Open the printer cover and make sure that the print head is in the home (far right) position. If not, turn on the printer and wait until the print head returns to the home position. Then turn off the printer and close the printer cover.



Caution:

Leave the ink cartridges installed during transportation, otherwise the printer may be damaged.

2. Unplug the power cord from the electrical outlet; then disconnect the interface cable from the printer.
3. Remove the paper from the sheet feeder and remove the paper support.
4. Push in the output extension tray, and then raise the output tray.
5. Attach the protective materials to the printer.
6. Repack the printer and power cord in the original box.
7. Keep the printer level during transport.

Character Tables

These character tables are selected with the default-setting mode or by using software commands.

All tables except the italic character table are the same as the PC437 table for hex codes 00 through 7F, so only the PC437 table is shown in its entirety. The rest of the tables show only the characters for hex codes 80 through FF.

The tables with an asterisk (*) after the table name are only available in certain areas.

PC437 (U.S./Standard Europe)

PC850(Multilingual)

PC860(Portuguese)

PC861(Icelandic)

PC863(Canadian-French)

PC865(Nordic)

BRASCII

Abicomp

Roman 8

ISO Latin 1

*PC437Greek(Greek)**

*PC852(East Europe)**

*PC853(Turkish)**

*PC855(Cyrillic)**

*PC857(Turkish)**

*PC866(Russian)**

*PC869(Greek)**

*MAZOWIA (Polish)**

*Code MJK (CSFR)**

*ISO 8859-7 (Latin/Greek)**

*ISO Latin 1T (Turkish)**

*Bulgaria**

*PC774 (LST 1283: 1993)**

*Estonia**

*ISO 8859-2**

*PC866 LAT. (Latvian)**

*PC866 UKR**

*PC APTEC(Arabic)**

*PC708(Arabic)**

*PC720(Arabic)**

*PC AR864(Arabic)**

Italic

No characters are available for hex code 15 in the italic character table.

International character sets

You can select one of the following international character sets with the default-setting mode or the ESC R command. For example, when you select “Italic France,” the characters in the “France” row on the table below are used in the italic character table.

The following eight international character sets can be selected with the default-setting mode or with the ESC R command.

The following seven additional sets can be selected only with the ESC R command.

Characters available with ESC (^ command

To print the characters in the table below, use the ESC (^ command. The characters in the right table are available with PC864 (Arabic), PC AR864 (Arabic), and PC APTEC (Arabic).

EPSON