

SCI7660 series POWER SUPPLY IC

1.

DC/DC Converter

DESCRIPTION

The SCI7660 Series is a highly efficient CMOS DC/DC converter for doubling an input voltage. This power-saving IC allows portable computers and similar hand-held equipment to operate from a single power supply, even when they incorporate LSIs that operate at voltages different from those of logic circuits, for example, LCD drivers and analog LSIs.

The SCI7660C0B is available in 8-pin plastic DIPs, and the SCI7660M0B, in 8-pin plastic SOPs.

FEATURES

- 95% (typ.) conversion efficiency
- Two output voltages, V_O , relative to V_{DD} and V_I
- 30mA maximum output current at 5V
- Two-in-series configuration doubles negative output voltage.
- Low operating voltage
- On-chip RC oscillator
- 8-pin plastic DIP and 8-pin plastic SOP

APPLICATIONS

- Fixed-voltage power supplies for battery-operated equipment
- Power supplies for pagers, memory cards, calculators and similar hand-held equipment
- Fixed-voltage power supplies for medical equipment
- Fixed-voltage power supplies for communications equipment
- Uninterruptable power supplies

BLOCK DIAGRAM

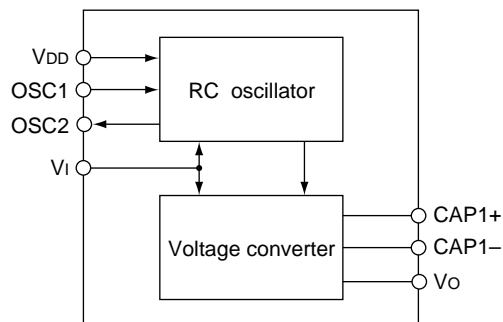

PIN CONFIGURATION

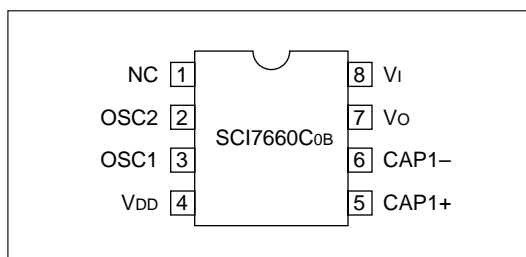

PIN DESCRIPTION

Number	Name	Description
1	NC	No connection
2	OSC2	Resistor connection. Open when using external clock
3	OSC1	Resistor connection. Clock input when using external clock
4	V_{DD}	Positive supply (system V_{CC})
5	CAP1+	Positive charge-pump connection
6	CAP1-	Negative charge-pump connection
7	V_O	$\times 2$ multiplier output
8	V_I	Negative supply (system ground)

SPECIFICATIONS

Absolute Maximum Ratings

Parameter	Symbol	Rating	Unit
Input voltage range	V_I	-10.0 to 0.5	V
Output voltage range	V_O	Min. -20.0	V
Power dissipation	P_D	300 (DIP)	mW
		150 (SOP)	
Operating temperature range	T_{opr}	-40 to 85	°C
Storage temperature range	T_{stg}	-65 to 150	°C
Soldering temperature(for 10s). See note.	T_{sol}	260	°C

Note:

Temperatures during reflow soldering must remain within the limits set out in LSI Device Precautions. Never use solder dip to mount SCI7000 series power supply devices.

Recommended Operating Conditions

$V_{DD} = 0V$, $T_a = -40$ to 85°C unless otherwise noted

Parameter	Symbol	Condition	Rating			Unit
			Min.	Typ.	Max.	
Oscillator startup voltage	V_{STA}	$R_{OSC} = 1M\Omega$, $C_1/C_2 \leq 1/20$, $C_2 \geq 10\mu\text{F}$, $T_a = -40$ to 85°C See note 1.	—	—	-1.5	V
		$R_{OSC} = 1M\Omega$	—	—	-2.2	
Oscillator shutdown voltage	V_{STP}	$R_{OSC} = 1M\Omega$	-1.5	—	—	V
Load resistance	R_L		R_L min See note 2.	—	—	Ω
Output current	I_O		—	—	30.0	mA
Clock frequency	f_{OSC}		10.0	—	30.0	kHz
RC oscillator network resistance	R_{OSC}		680	—	2,000	$k\Omega$
Capacitance	C_1, C_2		3.3	—	—	μF

Notes:

- The recommended circuit configuration for low-voltage operation (when V_I is between -1.2V and -2.2V) is shown in the following figure. Note that diode D1 should have a maximum forward voltage of 0.6V with 1.0mA forward current.
- R_L min can be varied depending on the input voltage.

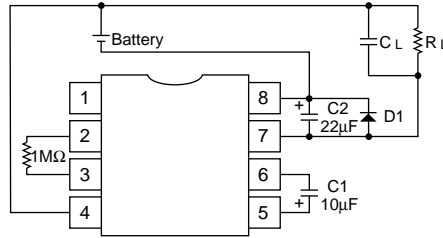

3. R_L min is a function of V_I .

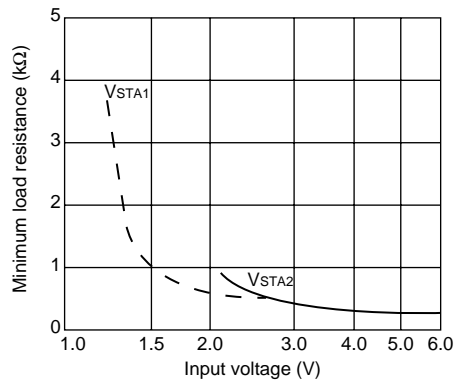

Electrical Characteristics

$V_{DD} = 0V$, $T_a = -40$ to $85^\circ C$ unless otherwise noted

Parameter	Symbol	Condition	Rating			Unit
			Min.	Typ.	Max.	
Input voltage	V_I		-8.0	—	-1.5	V
Output voltage	V_O		-16.0	—	—	V
Multiplier current	I_{opr}	$R_L = \infty$, $R_{OSC} = 1M\Omega$ $V_I = -5V$	—	20	30	μA
Quiescent current	I_Q	$R_L = \infty$, $V_I = -8V$	—	—	2.0	μA
Clock frequency	f_{osc}	$R_{osc} = 1M\Omega$, $V_I = -5V$	16	20	24	kHz
Output impedance	R_o	$I_o = 10mA$, $V_I = -5V$	—	75	100	Ω
Multiplication efficiency	P_{eff}	$I_o = 5mA$, $V_I = -5V$	90	95	—	%
OSC1 Input leakage current	I_{LKI}	$V_I = -8V$	—	—	2.0	μA

Typical Performance Characteristics

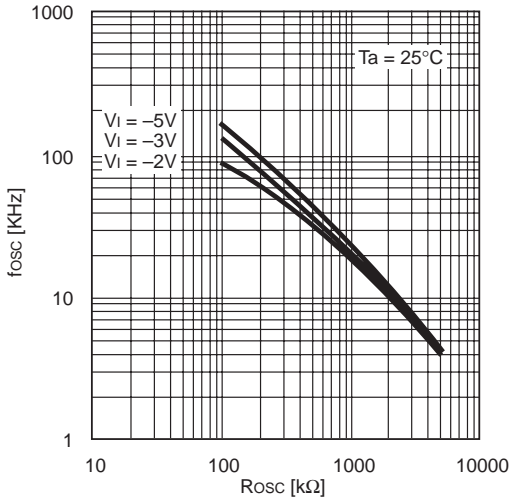

Clock frequency vs. External resistance

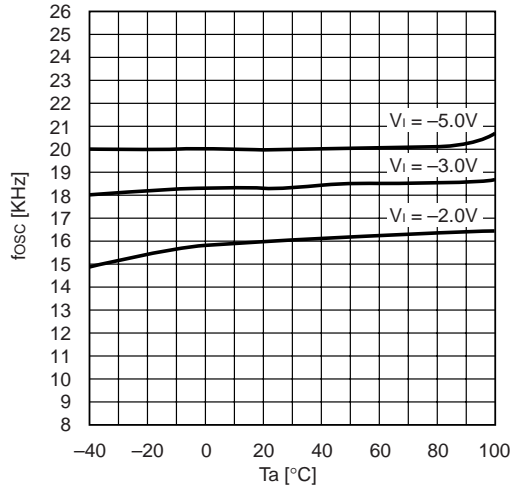

Clock frequency vs. Ambient temperature

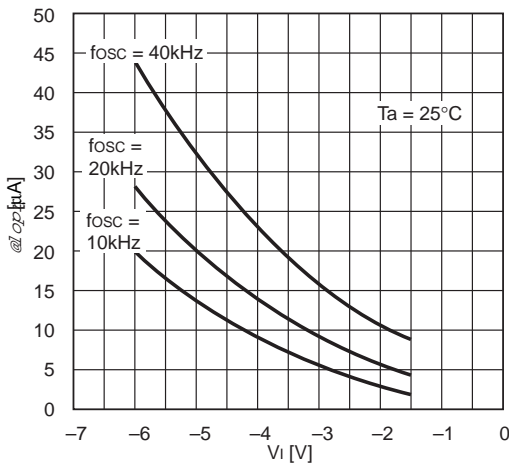

Multiplier current vs. Input voltage

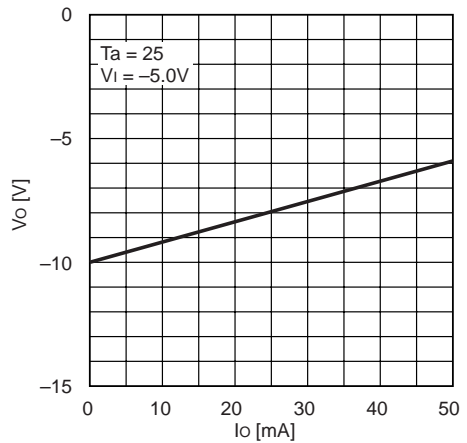

Output voltage vs. Output current

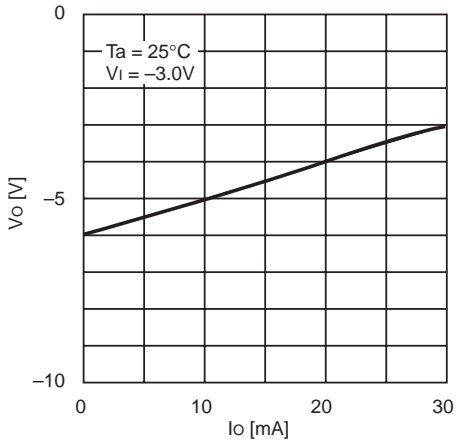

Output voltage vs. Output current

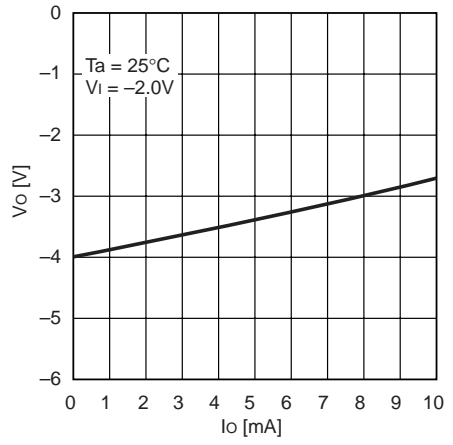

Output voltage vs. Output current

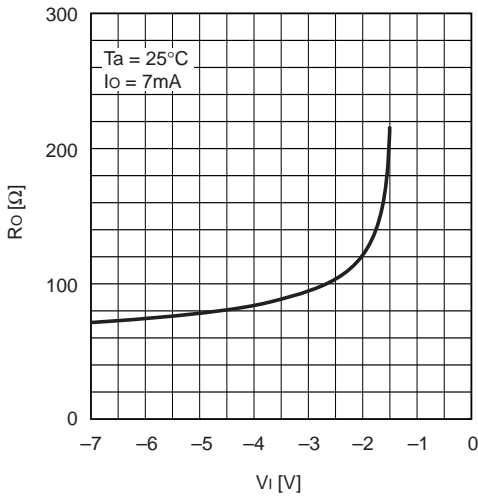

Output impedance vs. Input voltage

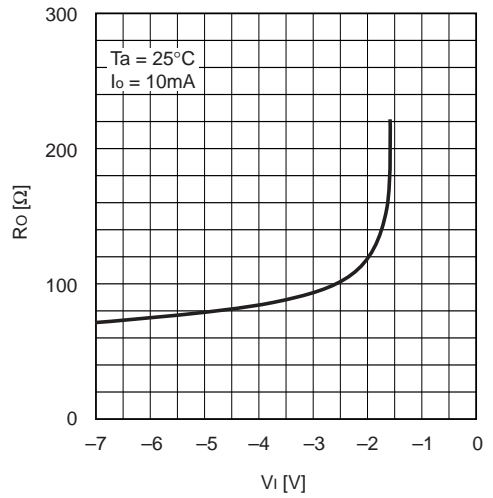

Output impedance vs. Input voltage

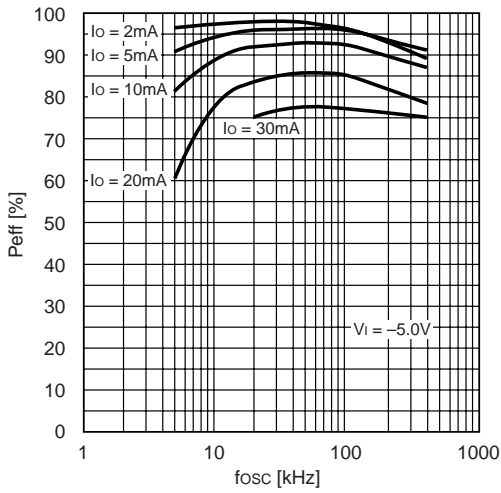

Multiplication efficiency vs. Clock frequency

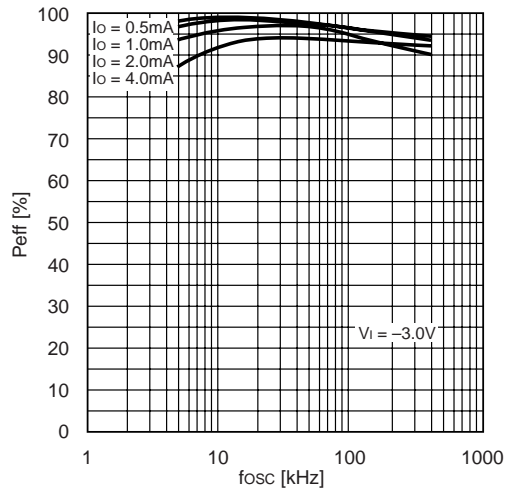

Multiplication efficiency vs. Clock frequency

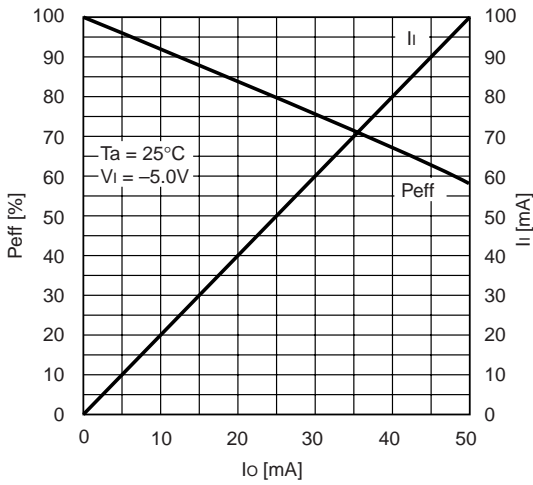

Multiplication efficiency/input current vs. Output current

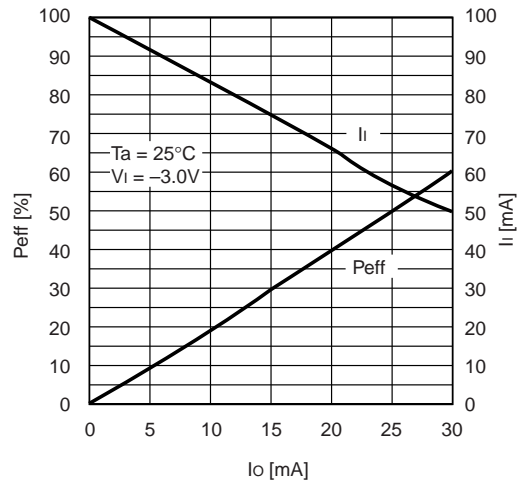

Multiplication efficiency/input current vs. Output current

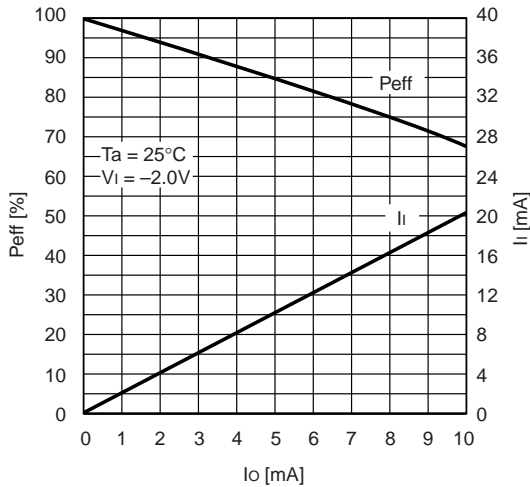

Multiplication efficiency/input current vs. Output current

FUNCTIONAL DESCRIPTION

RC Oscillator

The on-chip RC oscillator network frequency is determined by the external resistor, R_{osc} , connected between OSC1 and OSC2. This oscillator can be disabled in favor of an external clock by leaving OSC2 open and applying an external clock signal to OSC1.

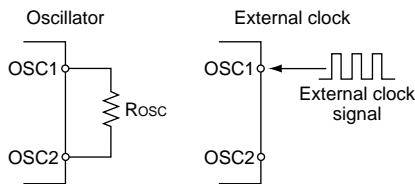

Voltage Multiplier

The voltage multiplier uses the clock signal from the oscillator to double the input voltage. This requires two external capacitors—a charge-pump capacitor, C1, between CAP1+ and CAP1-, and a smoothing capacitor, C2, between V_i and V_o .

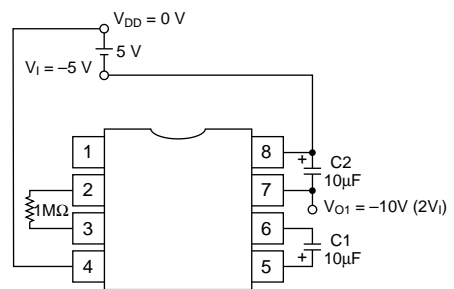

Doubled potential levels

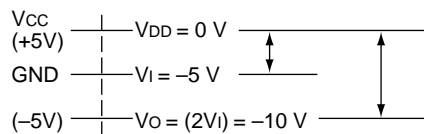

TYPICAL APPLICATIONS

Parallel Connection

Connecting two or more chips in parallel reduces the output impedance by $1/n$, where n is the number of devices used.

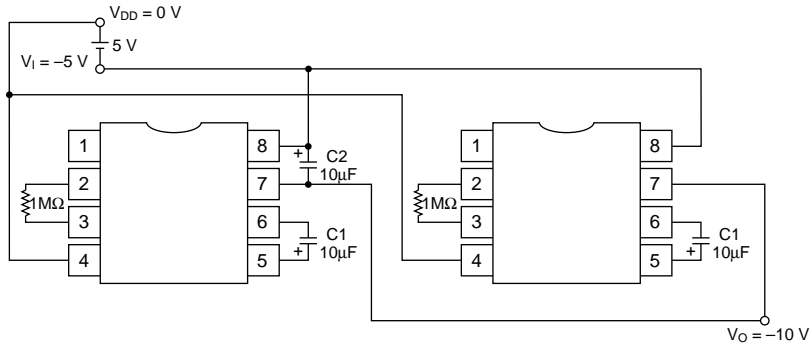

Serial Connection

Connecting two or more chips in series obtains a higher output voltage than can be obtained using a parallel

connection, however, this also raises the output impedance.

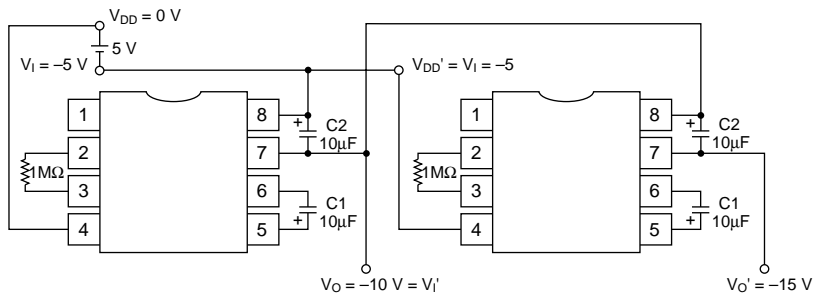

Potential levels

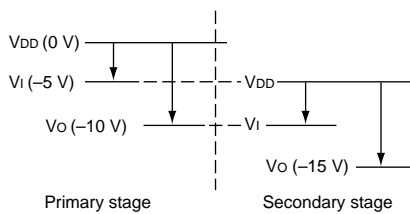

Positive Voltage Conversion

Diodes can be added to a circuit connected in parallel to make a negative voltage positive.

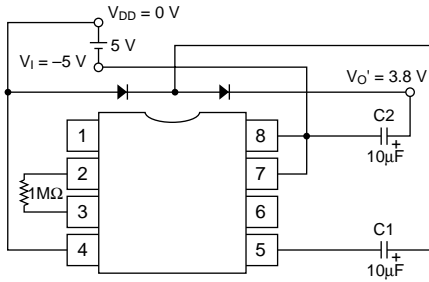

Simultaneous Voltage Conversion

Combining a multiplier circuit with a positive voltage conversion circuit generates both -10 and 3.8 V outputs from a single input.

Potential levels

