

1 Unpacking

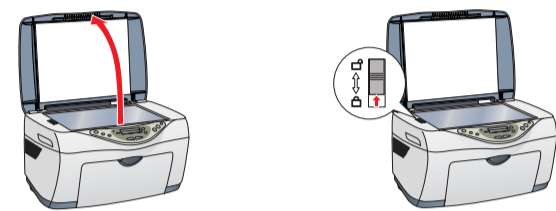

2 Setting Up the Stylus CX

1. Unlocking



2. Attaching the Parts

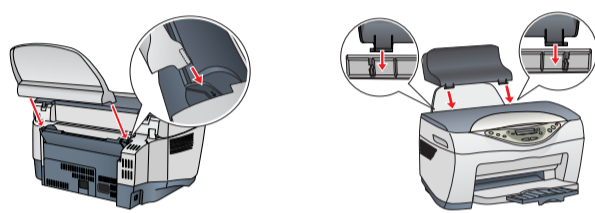

3. Plugging in the Power Cord

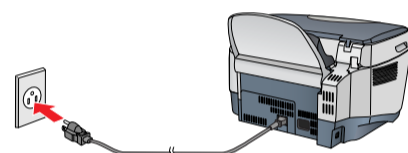

4. Installing the Ink Cartridges

1. Press the **On** button to turn on this product.

2. Shake the package of ink cartridges four or five times, then open the package and remove the ink cartridges.

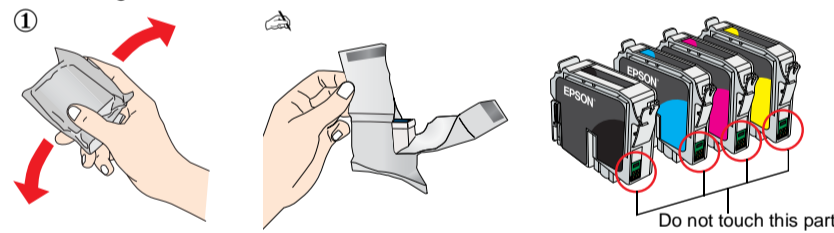
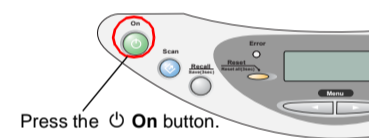

- !** **Caution:**
- Be careful not to break the hook on the side of the cartridge when you remove it from the package.
 - Do not shake the ink cartridge after removing from the package; this can cause leakage.
 - Do not remove or tear the label on the cartridge; this can cause leakage.

3. Insert the ink cartridges as illustrated below.

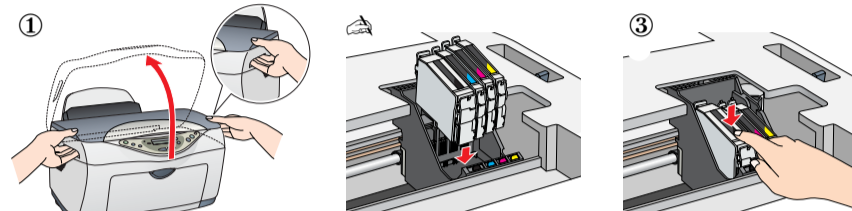

Note:
Install all ink cartridges. This product does not work unless all cartridges are installed properly.

4. Close the scanner unit.

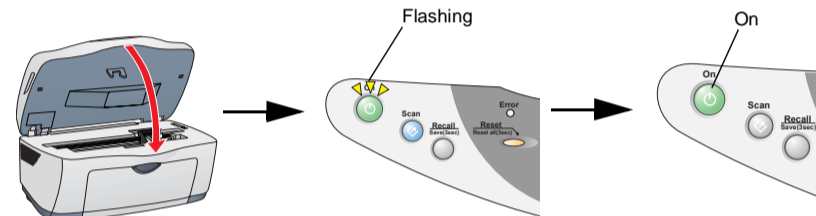

Ink charging starts. It takes about **two minutes**. While charging, this product produces a variety of mechanical sounds. This is normal. When the **On** light stops flashing, ink charging is complete.

- !** **Caution:**
- Do not turn the power off during the ink charging process.
 - Do not load paper until ink charging is complete.

Note:
The ink cartridges packaged with this product are partly used during the initial setup. To produce high quality printouts, the print head in this product must be fully charged with ink. This one-time process consumes a considerable amount of ink, but subsequent cartridge sets will last for their full rated life.

5. Selecting Language

You can select your preferred language for use on the LCD panel. For details, see Chapter 1 in the Copy Guide.

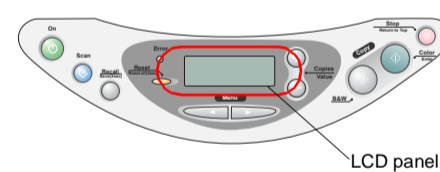

This product is now ready to make copies. See "Using the Copy Feature". If you want to print data or scan images, set up your computer as described below.

3 Setting Up the Computer

1. Connecting

1. Turn off your Stylus CX.



Note:
Do not turn on this product until a message prompts you to do so.

2. Connect the USB cable.

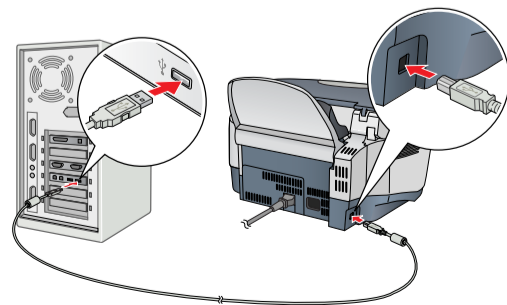

Note:
If the "Add New Hardware Wizard" dialog box appears, click **Cancel** and disconnect the USB cable from this product. Then return to step 1. Connecting.

2. Installing the Software

! **Caution for Macintosh users:**
Turn off all virus protection programs before you install the software.

For Mac OS X users, see "Installing the Software for Mac OS X".

- Make sure that this product is off.
- Insert the software CD into the CD-ROM drive.
For users of Mac OS 8.6 to 9.x:
Double-click the **EPSON** icon in the EPSON folder.
- The EPSON Installation Program dialog box appears. Select **Install Software**, and then click **OK**.
- Follow the on-screen instructions.
- For users of Mac OS 8.6 to 9.x
After installing the software, choose **Chooser** from the Apple menu, and then select the icon for this product and the port that this product is connected to.

For users of Mac OS 8.6 to 9.x



Note for Windows users:
You may need to restart your computer while installing the software. If a message instructing you to restart appears, remove the software CD, then click **Restart**. After restarting make sure this product is off, then reinstall the software.

This product is now ready to print and scan. The Reference Guide includes detailed information about printing and scanning. To view the Reference Guide, see "Viewing the Reference Guide".

Using the Copy Feature

1. Preparation

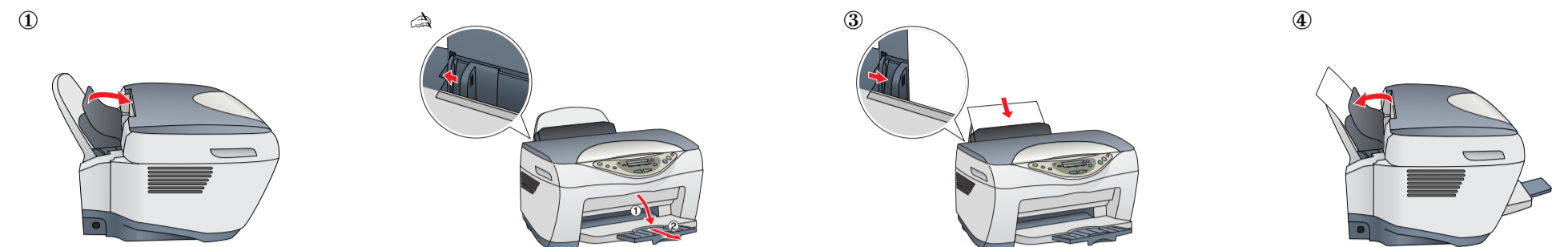

2. Making a Copy

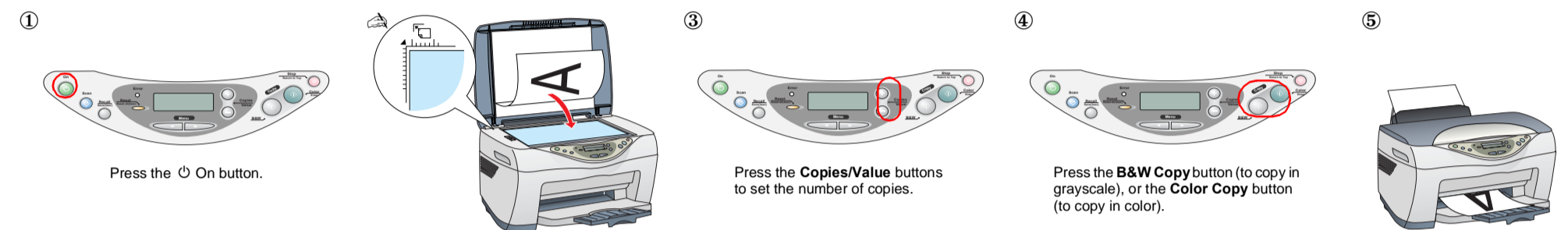

Select Various Copy Modes and Other Options

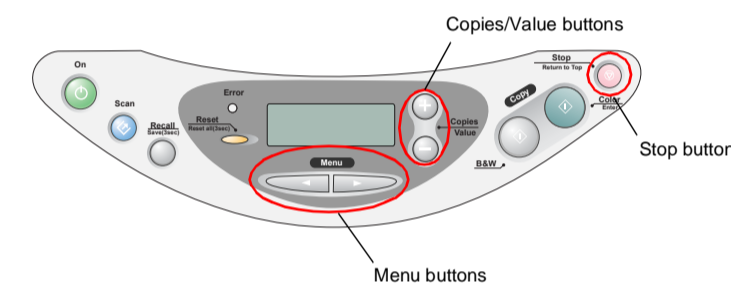

This product provides you with a variety of copying options. You can choose from various formats and use many different types of paper.

- Press one of the **Menu** buttons until **COPY Mode** appears on the LCD panel.
- Press one of the **Copies/Value** buttons until the desired copy mode appears.

Note:
Be sure to select the copy mode first, because other copy settings return to default values when the copy mode changes.

- Use the **Menu** and **Copies/Value** buttons to make other copy settings.
 - Press the **Stop** button. The settings you made appear on the LCD panel.
- See the Copy Guide for the available menu items in each copy mode.

Standard Copy

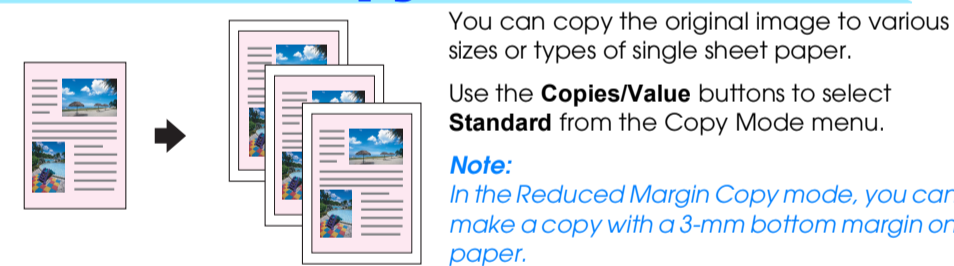

Repeat Copy

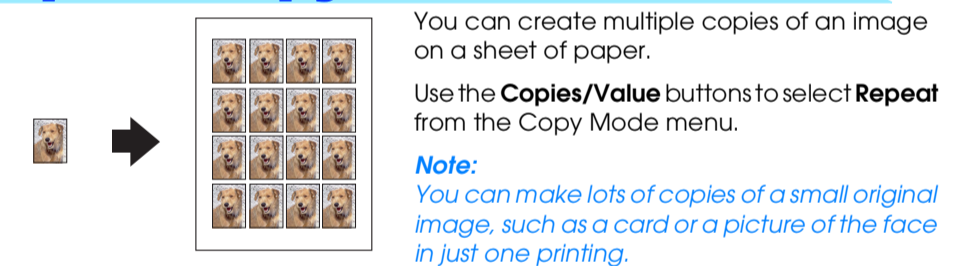

2-up Copy/4-up Copy

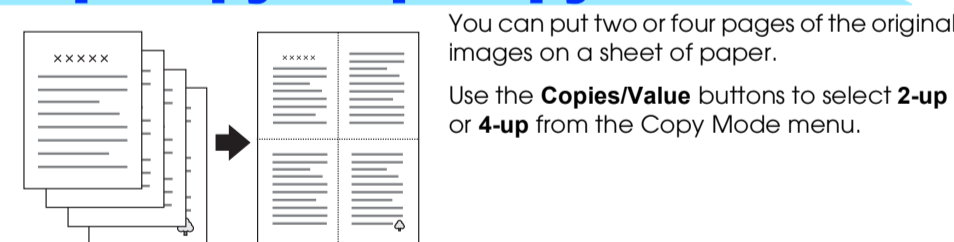

Auto Fit Page

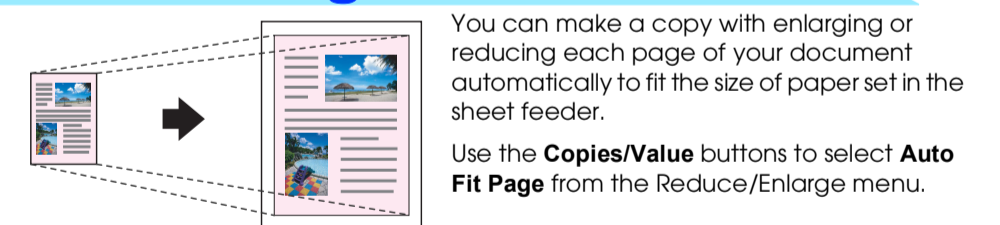

Installing the Software for Mac OS X

- Make sure that this product is off and insert the software CD into the CD-ROM drive.
- Double-click the **Mac OS X Driver** folder. → Double-click the **EPSON TWAIN** folder. → Double-click your preferred language folder. → Double-click the **EPSON TWAIN** folder. → Double-click the **EPSON TWAIN 5 Installer** icon. Follow the on-screen instructions to install EPSON TWAIN.
If the Authorization window opens, click the key icon, enter the administrator's name and password, click **OK**, and then click **Continue**.
- After installing EPSON TWAIN, double-click the **EPSON Scan to File** folder in your preferred language folder, and then double-click the **EPSON Scan to File Installer** icon to install EPSON Scan to File.
- After installing EPSON Scan to File, double-click the **Printer Driver** folder in the **Mac OS X Driver** folder, and then double-click **CX5200.pkg** to install the printer software.
- After installing the software, follow the instruction below to select this product:
Double-click **Macintosh HD**. → Double-click the **Applications** folder. → Double-click the **Utilities** folder. → Double-click the **Print Center** icon. → Click **Add Printer**. → Select **EPSON USB**. → Select this product. → Click **Add**.

Viewing the Reference Guide

To learn more about this product, see the *Online Reference Guide*.

For Windows users

- Insert the software CD into the CD-ROM drive. The Installer dialog box appears. If the dialog box does not appear, double-click **SETUP.EXE** in the CD-ROM.
- Select **User Guides** and click **OK**.

For users of Mac OS 8.6 to 9.x

- Insert the software CD into the CD-ROM drive.
- Double-click the **EPSON** icon inside the EPSON folder, then select **User Guides** and click **OK**.

For Mac OS X users

- Insert the software CD into the CD-ROM drive.
- Double-click the **Manual** folder inside the EPSON folder, then double-click the **REF_G** folder in your preferred language folder. Then double-click the **INDEX.HTM**.