

**EPSON®**



**M M PROJECTOR**  
ULTI EDIA

**EMP-713/703/503™**

**Owner's Manual**

# Types of Manual

The documentation for your EPSON projector is divided into the following three manuals. The manuals cover the following topics.

- **Safety Instructions/World-Wide Warranty Terms**  
This manual contains information on using the projector safely, and also includes World-Wide Warranty Terms and a Troubleshooting check sheet.  
Be sure to read this manual thoroughly before using the projector.
- **Owner's Manual (this manual)**  
This Owner's Manual contains information on installing the projector, basic operation, using the projector menus, troubleshooting and maintenance.
- **Quick Reference Guide**  
Contains an overview of the most commonly-used projector functions for easy reference. You should keep this Quick Reference Guide near the projector at all times and refer to it before starting presentations and while using the projector in order to check details of operation.

# EPSON®

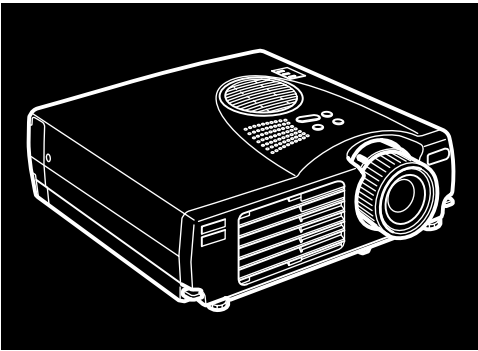

## **EMP-713/703/503™**

**DATA/VIDEO PROJECTOR**

Owner's Manual



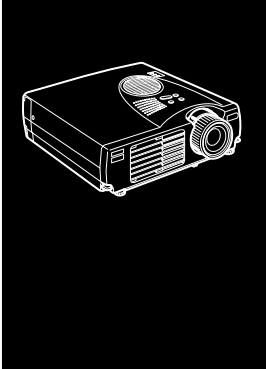

# Contents

<b>Contents</b>	<b>iii</b>
<b>Introduction</b>	<b>vii</b>
Getting the Most Out of Your Projector .....	ix
Optional Accessories .....	ix
About This Manual .....	x
Where to Get Help .....	xi
World Wide Web site .....	xi
<b>1 Installation</b>	<b>1</b>
Unpacking the Projector .....	2
Additional Components .....	3
Setting Up the Projector .....	4
Connecting to a Computer .....	6
Connecting to a PC Desktop Computer .....	7
Connecting to a PC Laptop Computer .....	10
Connecting to a Desktop Macintosh .....	13
Connecting to a PowerBook .....	17
Connecting to a Video Source .....	22
Connecting to an External Speaker or PA System .....	25



<b>2 Using the Projector</b>	<b>27</b>
Turning the Equipment On and Off .....	29
Turning the Projector On and Off .....	29
Focusing and Positioning the Screen Image .....	31
Resize Button .....	33
Controlling the Projector .....	34
Using the Remote Control .....	35
Using the Operation Panel .....	38
Projector Status Indicators .....	39
Operation Indicator .....	39
Lamp Indicator .....	40
Temperature Indicator .....	40
<b>3 Using the Projector Menus</b>	<b>43</b>
Accessing the Main Menu .....	44
Changing a Menu Setting .....	45
Menu Options .....	47
Video Menu (Image source = Computer) .....	47
Video Menu (Image source = Video) .....	49
Audio Menu .....	50
Effect Menu .....	51
Setting Menu .....	51
User's Logo Menu .....	52
Reset All Menu .....	54
Advanced Menu .....	55
About Menu .....	56
<b>4 Maintenance</b>	<b>57</b>
Cleaning the Lens .....	58
Cleaning the Projector Case .....	58
Cleaning the Air Filter .....	59
Replacing the Lamp .....	60

---

<b>5 Troubleshooting</b>	<b>63</b>
Problems with the Projector.....	64
Problems with the Image or Sound.....	66
<b>Technical Specifications</b>	<b>69</b>
Supported Monitor Displays .....	71
Computer In connector pin assignments .....	73
<b>Glossary</b>	<b>75</b>
<b>Index</b>	<b>77</b>







# Introduction

Your compact, lightweight EPSON EMP-713/703/503 projector lets you project full-color images and video onto a large screen for presentations. You can connect it simultaneously to two image sources: one PC or Apple® Macintosh® computer image source, plus one video source such as a video tape deck, camcorder, or digital camera. You can also connect audio for each image source.

Images are displayed in full color (16,670,000 colors) at a XGA resolution of 1024 x 768 pixels (EMP-713/703) and SVGA resolution of 800 x 600 pixels (EMP-503). Your projector produces bright images that can be easily seen in rooms light enough to take notes.

A totally new AVTSS™ (Automatic Video Tracking and Synchronization Sensing, patent pending) provides automatic set-up of image from a computer.

You control your projector through a hand-held remote control unit, with menus being provided for image source switching and image adjustment. The remote control can also act as a wireless mouse to control mouse operations on your computer screen during presentations.

---

Your projector features the newest resizing technology DAR (Digital Active Resizing) which supports VGA~UXGA computer output (The EMP-503 does not support UXGA). No matter what type of computer output is used, the result is a full-size video image of outstanding clarity.

The video source can be NTSC, NTSC4.43, NTSC50, PAL M-PAL, N-PAL, PAL60 or SECAM in composite video or S-Video format. See Chapter 6 for details on supported computers and video formats.

---

# Getting the Most Out of Your Projector

Your projector comes with a full set of features that enable you to control the settings for the image display, video and audio. To get the most out of your projector, read this section for a quick summary of the important features.

## Optional Accessories

To enhance your use of the projector, EPSON provides the following optional accessories:

- Image Presentation Camera (XGA) ELPDC02
- Image Presentation Camera (PAL/NTSC) ELPDC03
- Computer Cable ELPKC02
- VGA-HD15 PC Cable (3.0m) ELPKC09
- VGA-HD15 Extension Computer Cable (20m) ELPKC10
- Soft Carrying Case (for PC) ELPKS16
- Soft Carrying Case ELPKS24
- Spare Lamp ELPLP14
- Portable Screen (50") ELPSC06
- 60" Screen ELPSC07
- 80" Screen ELPSC08
- Ceiling Mount (Silver)\* ELPMB09

You can purchase these accessories from your dealer.

\* A special technique is necessary to suspend the projector from the ceiling. Please consult with your dealer if you are planning to suspend the projector from the ceiling when you use it.

---

# About This Manual

Chapter 1, “Installation”, gives step-by-step instructions on how to set up the projector and connect it to your computer, video source, or other external speaker or PA system. Read the installation procedures that apply to your configuration.

Chapter 2, “Using the Projector”, describes how to switch the projector on/off and control simple projector settings using the remote control or the operation panel.

Chapter 3, “Using the Menus”, describes how to use the menus to adjust the color and image settings, change the display of the projected image, and modify audio settings.

Chapter 4, “Maintenance”, describes how to clean your projector and perform limited maintenance.

Chapter 5, “Troubleshooting”, describes how to interpret your projector’s indicator lights and gives helpful information for avoiding errors, optimizing image quality and solving problems.

Chapter 6, “Technical Specifications,” lists the technical specifications for your projector.

A Glossary and Index are provided at the end of the manual.

---

# Where to Get Help

If you are having trouble setting up or running your projector, first see Chapter 5, “Troubleshooting”. If you cannot resolve the problem, contact the appropriate representative listed in the section entitled “International Warranty Conditions” in “Safety Instructions/World-Wide Warranty Terms” included in the package.

Before you call, please have the following information ready:

- Product name
- Product serial number
- Computer configuration
- Description of the problem

## World Wide Web site

If you connect to the Internet and have a Web browser, you can access to EPSON’s World Wide Web site at <http://www.epson.com>. EPSON’s home page provides you What’s New, EPSON Products, EPSON Connection, Corporate Info and EPSON Contacts. Link to the EPSON Connection for the latest drivers and FAQ’s (Frequently Asked Questions) and the EPSON Chart area. To get in touch with EPSON around the world, EPSON Contacts includes Contact Information for local EPSON subsidiaries.





1



# Installation

This chapter describes how to unpack and set up your projector, and connect it to other equipment. The projector must be connected to a computer or a video source such as a video tape deck, camcorder, digital camera or laser disc player before it can project any images.

You may also want to set up the projector for one or more of the following:

- Connect the mouse cable to use the remote control as a wireless mouse.
- Provide audio for one or both image sources. The audio source can be the computer, video source, or another device such as a stereo.
- Connect to an external speaker or PA system to amplify the audio.

---

# Unpacking the Projector

When you unpack the projector, make sure you have all these components:

- Projector
- Remote control
- Two alkaline dry cells LR6 (AA)
- Power cord
- Computer cable
- Audio/Video cable (A/V cable)
- PS/2 mouse cable
- USB mouse cable
- Owner's manual
- Quick reference guide
- Safety Instructions/World-Wide Warranty Terms
- Softcase

Depending on the configuration of your equipment, you may not need all these components.

Save all packaging materials in case you need to ship the projector in the future. It should be transported in its original packaging or the equivalent.



---

## Additional Components

Depending on how you plan to use the projector, you may need these additional components:

- To receive an S-Video signal, you need an S-Video cable. (One is usually provided with your video device.) A separate cable is required for each video source.
- To connect the projector to a Macintosh PowerBook, you need a video-out cable.

(One is provided by/or can be purchased from Apple for all new PowerBooks that have video-out capability.) If your PowerBook does not include one, see your Macintosh dealer.

- To connect the mouse cable to your computer, you may require a special connector, cable, or other components. You can obtain these items from your computer dealer. If your computer doesn't have a mouse connector, you cannot use the mouse cable.

◆ **Note:** *You can connect a Kensington MicroSaver® anti-theft device in the hole on the projector's right side. Contact your computer dealer.*

---

# Setting Up the Projector

1. Place the projector on a sturdy, level surface within five feet of the computer or video source.

◆ **Caution:** *Do not hold the projector by the lens. This can damage the lens.*

2. Place the projector at a correct distance from the screen.

The distance between the projector and the screen determines the actual image size. Use the general guidelines below to determine the correct distance.

Screen size	Horizontal distance from projector to screen		
300 inches (610x460cm)	450.7 inches (11.5m)	~	546.3 inches (13.8m)
200 inches (410x300cm)	299.5 inches (7.7m)	~	363.3 inches (9.2m)
150 inches (305x228cm)	223.9 inches (5.7m)	~	271.7 inches (6.9m)
100 inches (200x150cm)	148.3 inches (3.8m)	~	180.2 inches (4.5m)
80 inches (160x120cm)	118.1 inches (3.0m)	~	143.6 inches (3.6m)
60 inches (120x90cm)	87.8 inches (2.3m)	~	107.0 inches (2.7m)
40 inches (81x61cm)	57.6 inches (1.5m)	~	70.4 inches (1.7m)
30 inches (61x46cm)	42.5 inches (1.1m)	~	52.1 inches (1.3m)
26 inches (53x40cm)	—	~	44.7 inches (1.1m)

3. Turn the projector so that the lens is at right angles to the screen. If the projector is not angled correctly, the screen image will be crooked.
4. Connect one end of the power cable to the projector's power connector. Connect the other end to an earthed electrical socket.  
The projector should be in sleep mode, indicated by an orange power indicator.

◆ **Warning:** *Never look into the lens when the projector is on. There is a risk that the projector might come on suddenly even though it is not in use. The light from the lamp can damage your eyes. It is especially important that children should not be allowed to look into the lens.*

- 
5. To insert the batteries in the remote control device, slide off the battery compartment cover.

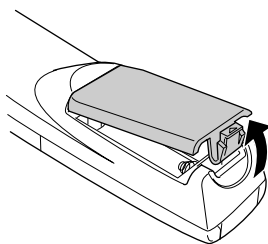

6. Insert the two alkaline dry cells LR6 (AA) included with the projector. Make sure the polarity of the batteries is correct.

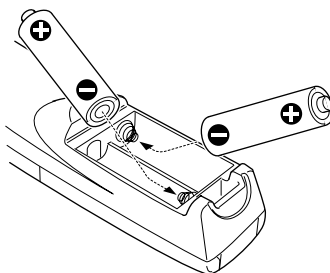

7. Replace the battery compartment cover.

When replacing batteries, take the following precautions:

- Do not recharge the used batteries or expose to fire or water.
- Replace batteries as soon as they run out. If the batteries leak, wipe away battery fluid with a soft cloth. If fluid gets on your hands, wash them immediately.
- Remove the batteries if you will not be using the projector for a long period of time.

# Connecting to a Computer

You can connect the projector to a computer capable of VGA, SVGA, XGA, SXGA and UXGA output (The EMP-503 does not support UXGA).

To connect the computer and mouse cables (to use the wireless remote as a mousepointer), see the section in this chapter that applies to your computer.

The illustration below identifies all the interface ports on the back of the projector; you may want to refer to this as you connect your computer or other equipment to the projector.

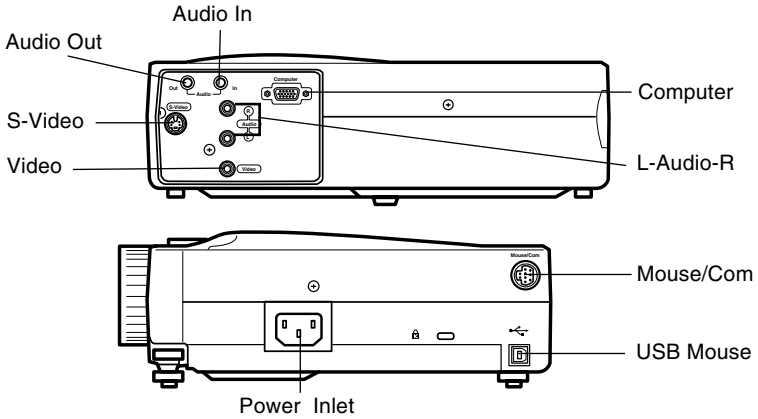

---

# Connecting to a PC Desktop Computer

To connect the projector to your PC desktop computer, you need to:

- Connect the computer cable
- Connect the audio cable (if you'll be projecting with audio)

Follow the steps in each section for the cables you need to connect. Before beginning, turn off the projector and computer if they are on.

- ◆ **Note:** *Computer configurations vary. See your computer manual for the location of the ports needed to connect your projector.*

## Connecting the Computer

Refer to this illustration while following the steps below.

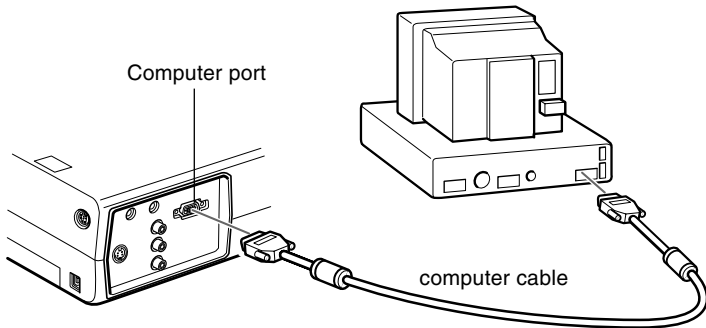

1. If you will be viewing the video on your computer monitor as well as the projector screen, disconnect the monitor cable from the video port on the back of your computer.
2. Connect one end of the computer cable to the projector's Computer port.

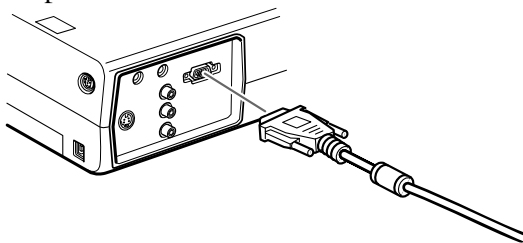

3. Connect the other end of the computer cable to the computer's video port.
4. Tighten the screws on all connectors.

## Connecting the Mouse Cables

If you want to use the remote control as a mouse, you need to connect the PS/2 mouse cable or USB mouse cable.

- ◆ **Note:** *The USB mouse port on the projector can only be used by connecting a USB mouse. It is not possible to connect other USB equipment for use.*

Refer to this illustration while following the steps below.

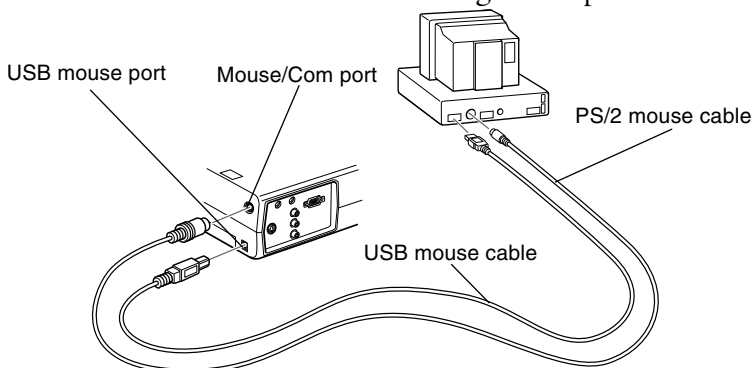

1. Connect the 9-pin end of the PS/2 mouse cable or, the USB mouse cable to the Mouse/Com or USB mouse port on the projector.

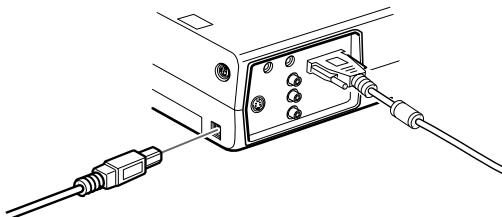

2. Disconnect your mouse from the mouse port on the back of your computer and replace it with the other end of the PS/2 mouse cable or USB mouse cable. (Your computer's mouse will be disabled while you are using the remote control as a mouse.)

## Connecting the Audio Cable

1. If you will be using audio, connect one end of the audio cable to the Audio In jack on the projector.

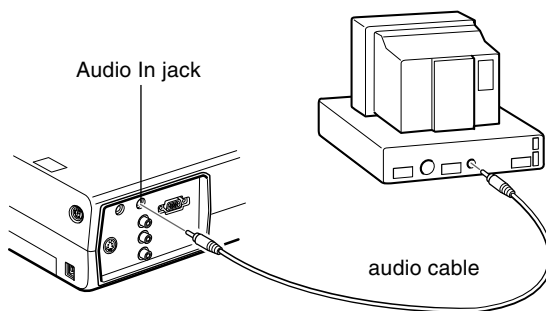

2. Connect the other end of the audio cable to the speaker or audio out port on the computer's sound card.

---

## Connecting to a PC Laptop Computer

To connect the projector to your PC laptop computer, you need to:

- Connect the computer cable
- Connect the mouse cable (if you want to use the remote control as a mouse)
- Connect the audio cable (if you'll be projecting with audio)

Follow the steps in each section for the cables you need to connect. Before beginning, turn off the projector and computer if they are on.

- ◆ **Note:** *Laptop configurations vary. See your computer manual for the location of the ports needed to connect your projector.*

### Connecting the Computer Cable

First connect the projector's computer cable to your laptop.

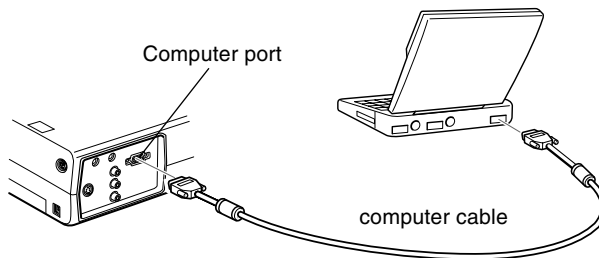

1. Connect one end of the computer cable to the projector's Computer port.
2. Connect the other end of the computer cable to the laptop's video (monitor) port.
3. Tighten the screws on all connectors.



---

## Connecting the Mouse Cables

If you want to use the remote control as a mouse, you need to connect the PS/2 mouse cable or USB mouse cable.

- ◆ **Note:** *The USB mouse port on the projector can only be used by connecting a USB mouse. It is not possible to connect other USB equipment for use.*

Refer to this illustration while following the steps below.

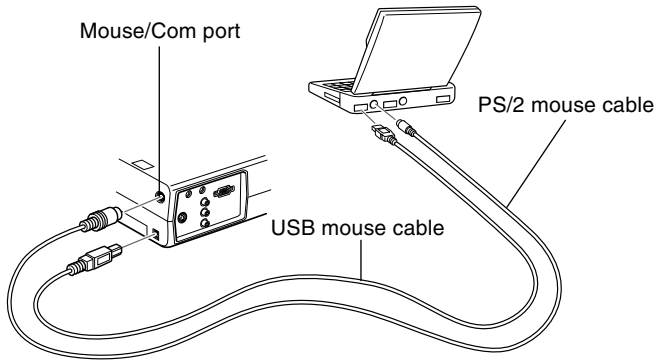

1. Connect the 9-pin end of the PS/2 mouse cable or USB mouse cable to the Mouse/Com or USB Mouse port on the projector.

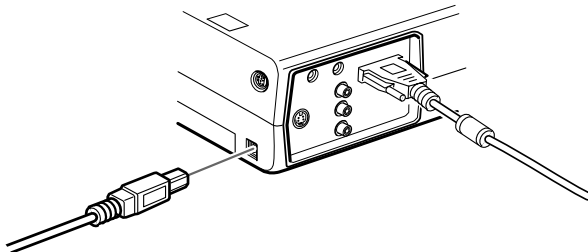

2. Connect the 6-pin (mini-DIN) end of the PS/2 mouse cable or USB mouse cable to the external mouse port or USB port on your laptop.
3. Configure your laptop to work with an external mouse.

- ◆ **Note:** You may have to set the display to appear on both the laptop's screen and the projector. Some laptops let you change this setting with the keyboard's function keys or by using a setup utility provided by the computer manufacturer. Check your laptop's manual or online help for instructions.

## Connecting the Audio Cable

1. If you will be using audio, connect one end of the audio cable to the Audio In jack on the projector.

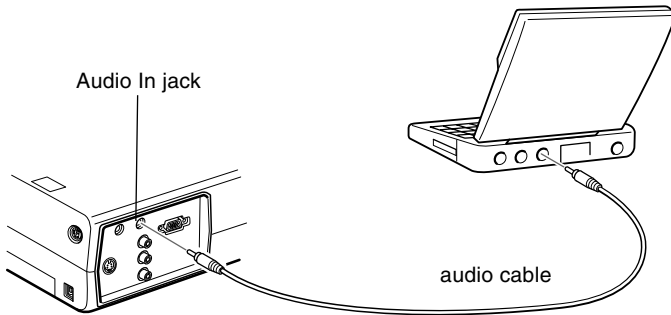

2. Connect the other end of the audio cable to your laptop.

---

# Connecting to a Desktop Macintosh

To connect the projector to your desktop Macintosh, you need to:

- Connect the computer cable
- Connect the mouse cable (if you want to use the remote control as a mouse)
- Connect the audio cable (if you'll be projecting with audio)

Follow the steps in each section for the cables you need to connect. Before beginning, turn off the projector and computer if they are on.

- ◆ **Note:** *Macintosh configurations vary. See your computer manual for the location of the ports needed to connect your projector.*

## Connecting the Computer Cable

First connect the computer cable. Refer to this illustration as you follow the steps below.

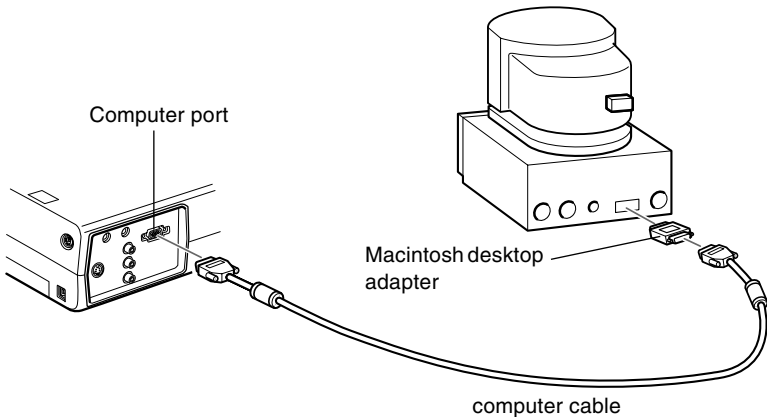

- 
1. Connect one end of the computer cable to the projector's Computer port.

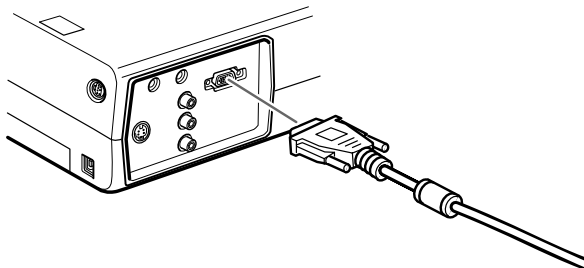

2. Remove the small cover on the Macintosh desktop adapter and set its DIP switches in accordance with the resolution you want to use (such as 16-inch mode). See your Macintosh documentation for instructions.

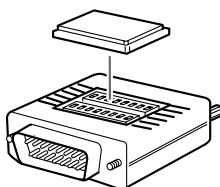

3. Connect the small terminal of the Macintosh desktop adapter to the other end of the computer cable.

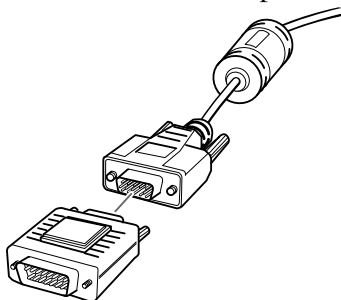

4. Connect the computer cable (with the Macintosh desktop adapter attached) to the video-out port on your Macintosh.

## Connecting the Mouse Cables

If you want to use the remote control as a mouse, you need to connect the USB mouse cable.

- ◆ **Note:** *The USB mouse port on the projector can only be used by connecting a USB mouse. It is not possible to connect other USB equipment for use.*

Refer to this illustration while following the steps below.

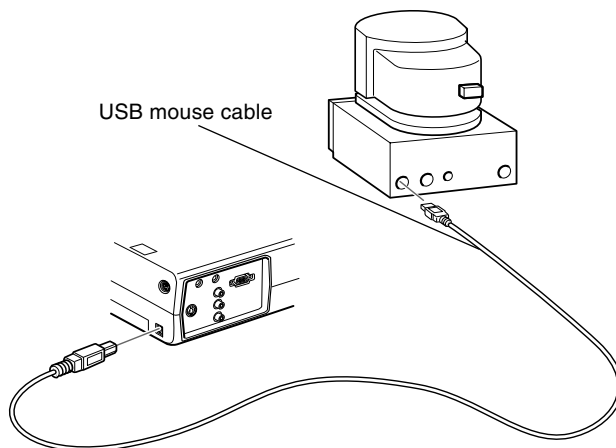

1. Connect one end of the projector's USB mouse cable to the USB Mouse port on the projector

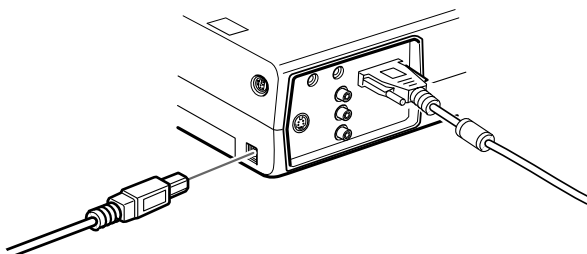

2. Disconnect your Macintosh's mouse cable. Connect the other end of the projector's USB mouse cable to the mouse port on your Macintosh.

## Connecting the Audio Cable

1. If you will be using audio, connect one end of the audio cable to the Audio In jack on the projector.

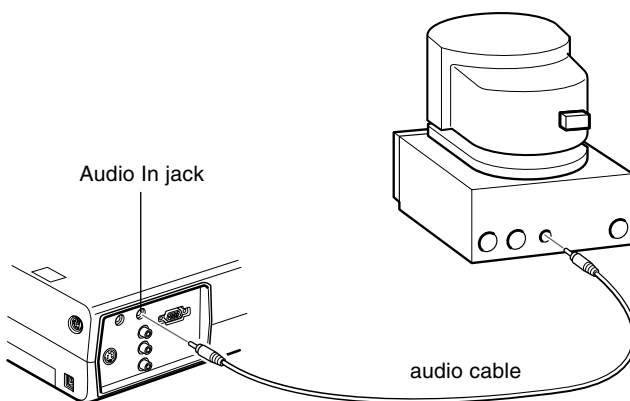

2. Connect the other end of the audio cable to the Audio Out port on your computer.

---

# Connecting to a PowerBook

Your PowerBook must have video-out capability in order to connect to the projector.

To connect the projector to your PowerBook, you need to:

- Connect the computer cable
- Connect the mouse cable (if you want to use the remote control as a mouse)
- Connect the audio cable (if you'll be projecting with audio)

Follow the steps in each section for the cables you need to connect. Before beginning, turn off the projector and computer if they are on.

- ◆ **Note:** *PowerBook configurations vary, so the location of your computer's ports may not match the illustrations. See your PowerBook manual for the port locations if necessary.*

## Connecting the Computer Cable

First connect the computer cable. Refer to this illustration as you follow the steps below.

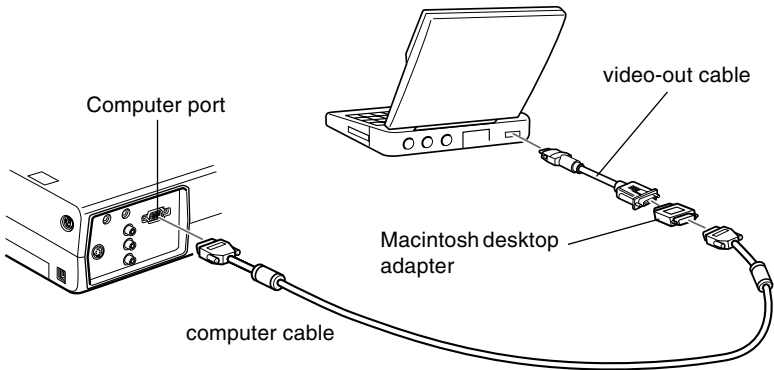



**Note:** Some new PowerBooks may allow you to connect the computer cable directly to the computer without using a video-out cable. See your PowerBook manual for additional information on connecting a computer cable.

1. Connect one end of the computer cable to the projector's Computer port.

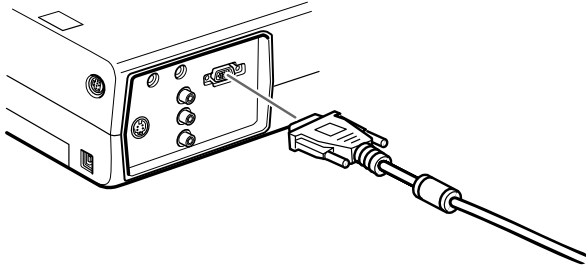

2. Remove the small cover on the Macintosh desktop adapter and set its DIP switches in accordance with the resolution you want to use (such as 16-inch mode). See your Macintosh documentation for instructions.

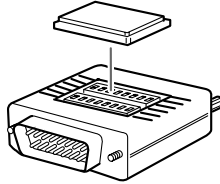



- 
3. Connect the small terminal of the Macintosh desktop adapter to the other end of the computer cable.

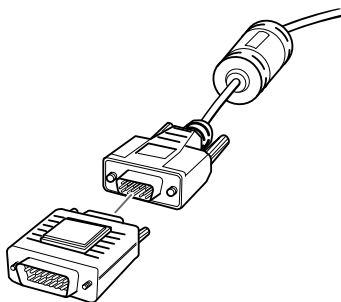

4. Connect the computer cable (with the optional Macintosh desktop adapter) to the video-out port on the PowerBook.

If a video-out cable was provided with your PowerBook, connect the smaller end of the video-out cable to the video-out port on the back of the PowerBook. Connect the other end to the Macintosh desktop adapter on the end of the computer cable.

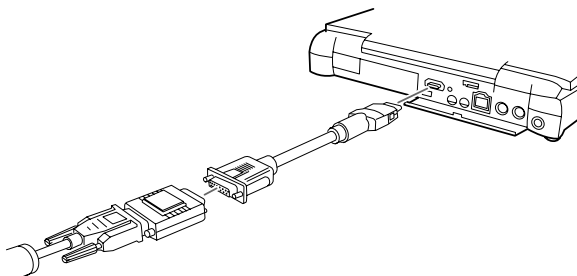

---

## Connecting the Mouse Cables

If you want to use the remote control as a mouse, you need to connect the USB mouse cable.

- ◆ **Note:** *The USB mouse port on the projector can only be used by connecting a USB mouse. It is not possible to connect other USB equipment for use.*

Refer to this illustration while following the steps below.

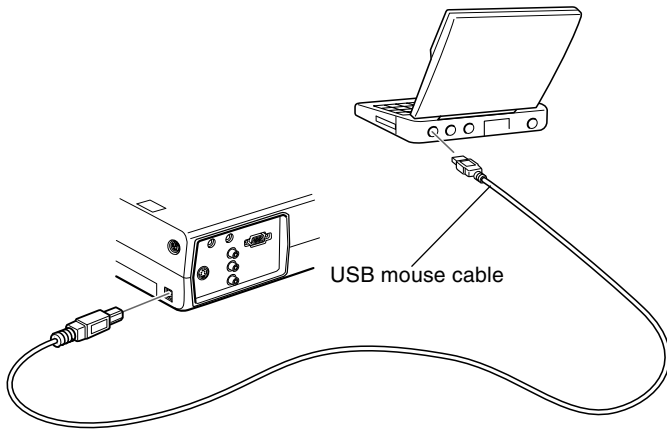

1. Connect one end of the projector's USB mouse cable to the USB Mouse port on the projector.

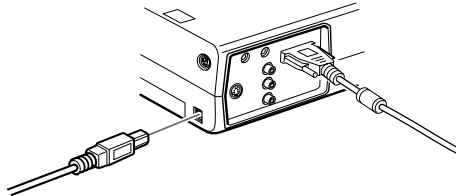

2. Connect the other end of the USB mouse cable to the mouse port on the back of the PowerBook.

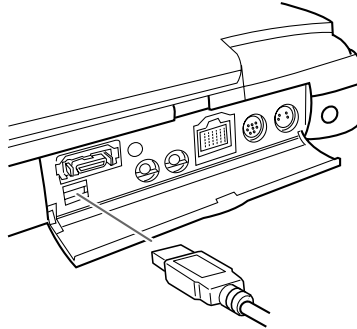

## Connecting the Audio Cable

1. If you will be using audio, connect one end of the audio cable to the Audio In jack on the projector.

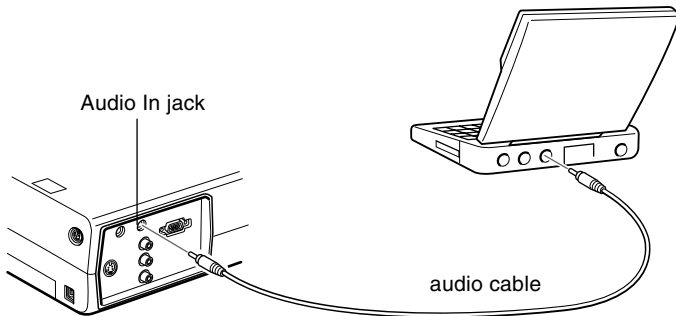

2. Connect the other end of the audio cable to the audio-out port on your PowerBook.

◆ **Note:** After you turn on the projector and computer, you'll need to choose *Mirroring* in the *Display Control Panel* if you set up your configuration to display on the LCD screen as well as the projector screen.

---

# Connecting to a Video Source

You can connect a VCR, a camcorder, a laser disc player, DVD player, or any other compatible video image source to your projector.

The projector can receive composite video or S-Video. Your equipment has composite video if your video source has a one-pin RCA video jack. Your equipment has S-Video if your video source has a four-pin (mini-DIN) video jack.

- ◆ **Note:** *The projector is not compatible with a cable TV-style F connector.*

You can connect the projector to an S-Video source and a composite video source at the same time.

The projector supports NTSC, PAL, and SECAM video formats, and automatically detects and identifies the video format. However, you can specify that a single broadcast format be detected. (See Chapter 3.) Note that the projector will then be able to detect only one type of video signal.

The type of cable you use to connect the video source to the projector depends on whether you have composite video or S-Video. For composite video, use the RCA audio and RCA video cable supplied with the projector. For S-Video, use the S-Video cable supplied with your video device or obtain one from your computer or video equipment dealer.



To connect a video source to the projector:

1. Turn off the projector and video source if they are on.

- 
2. If your video source uses a small, round, one-prong composite (RCA) video connector, you'll need the RCA video cable that comes with the projector. If your video source uses a large, round, four-prong S-Video connector, you will need to purchase the appropriate cable or use the cable that came with your video source.
  3. For Composite Video, connect the yellow RCA plug on one end of the RCA video cable to the projector's Video jack. Connect the other yellow RCA plug to the video-out jack of your video source.

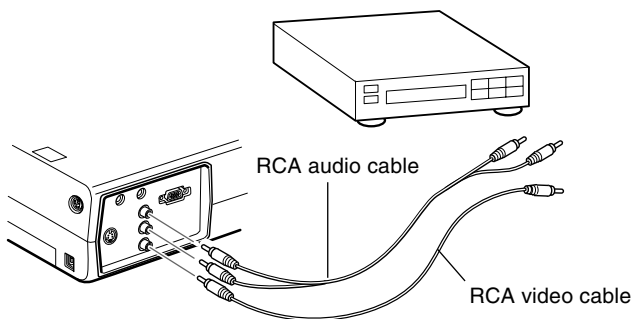

4. Connect the RCA audio cable to the Audio jacks of the projector: insert the white plug into the L jack and the red plug into the R jack. Connect the plug at the other end of the RCA audio cable to the audio output jacks of the video source.
5. For S-Video, insert one end of an S-Video cable into the projector's S-Video connector. Insert the other end into the S-video out jack of your video source.

- 
6. Connect the RCA audio cable to the Audio jacks of the projector: insert the white plug into the L jack and the red plug into the R jack. Connect the plug at the other end of the RCA audio cable to the audio output jack of the video source.

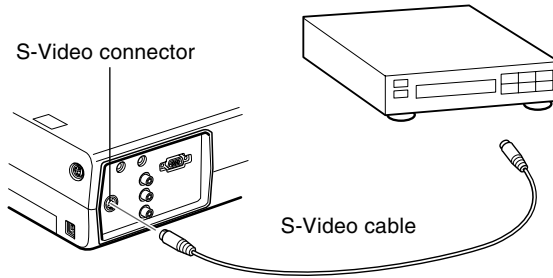

---

# Connecting to an External Speaker or PA System

Although the projector's internal speakers are enough for most small- or medium-size rooms, you can connect the projector to an external speaker or public address (PA) system for large rooms or to gain maximum benefit.

To connect the projector to an external sound system, you need to obtain an RCA-to-3.5 mm stereo audio cable. You can get one from your computer dealer.

1. Turn off the projector and speaker or PA system if they are on.
2. Connect the cable's 3.5 mm stereo miniplug to the projector's Audio Out jack.

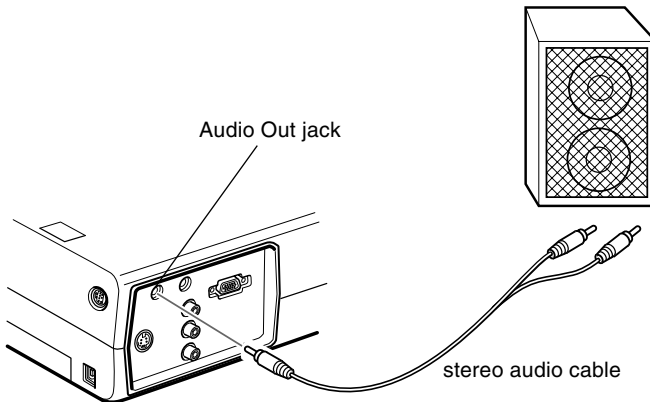

3. Connect the RCA plugs to the external amplified speaker or PA system. Insert the cable's red plug into the Audio R jack, and the white plug into the Audio L jack.

◆ **Note:** *The internal speakers are disabled when an external audio system is used.*







# 2

## Using the Projector

This chapter provides the following information about using your projector:

- Turning the equipment on and off
- Focusing and positioning the screen image
- Controlling the projector with the remote control and the operation panel
- Monitoring the projector's operating status

The illustration below identifies the parts of your projector.

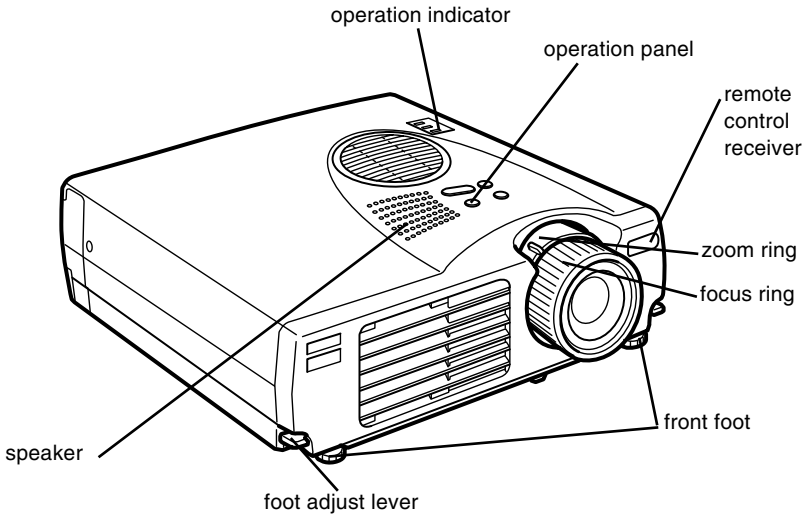

---

# Turning the Equipment On and Off

Turn on the projector and its attached equipment in the following order.

1. Computer
2. Video source
3. Audio source (if different from computer or video source)
4. Projector
5. External speaker or PA system (if necessary)

When you turn off the equipment, do so in the reverse order.

## Turning the Projector On and Off

1. Remove the projector lens cap.
2. When you plug in the projector power cord, the power indicator flashes orange for few seconds. Then the light remains orange.
3. Press the Power button on the remote control or operation panel. The power indicator flashes green as the projector warms up. When the projector is fully warmed up, this light remains green.

If computer or video equipment is attached, the computer or video signal is projected.

- ◆ **Warning:** *Never look into the lens when the lamp is on. This can damage your eyes. It is especially important that children are not allowed to look into the lens.*
- ◆ **Caution:** *When turning the projector on or off with the remote control, be sure to turn the remote control on first with the power switch.*

---

After you press the power button to turn off the projector, a confirmation message appears. If you want to turn off the projector, press the power button again. If you don't want to turn off the projector, press any button. The fan will remain on and the operation indicator will flash orange for about one minute as the projector cools down.

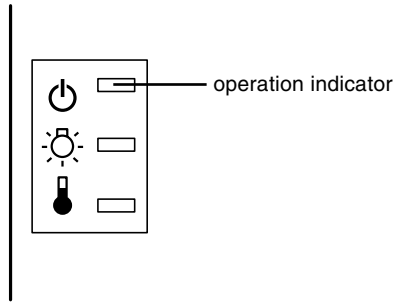

When the projector has cooled down, the operation indicator stops flashing and remains orange.

- ◆ **Note:** *If you press the Power button to turn the projector back on while the operation indicator is orange, there may be a delay before a projected image appears.*

---

# Focusing and Positioning the Screen Image

When an image appears on the screen, check that it is in focus and correctly positioned on the screen.

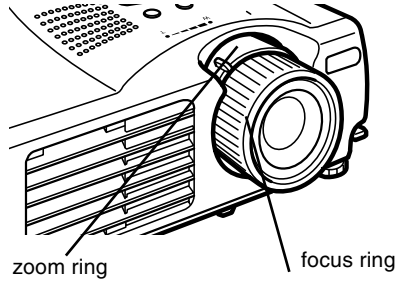

- To focus the image, rotate the focus ring (the outer ring on the lens).
- To adjust the size of the image, rotate the inner zoom ring. Rotate the zoom ring between W (wide) and T (tele) marks.

---

If you need to raise or lower the image on the screen, extend or retract the two feet at the bottom of the projector as follows:

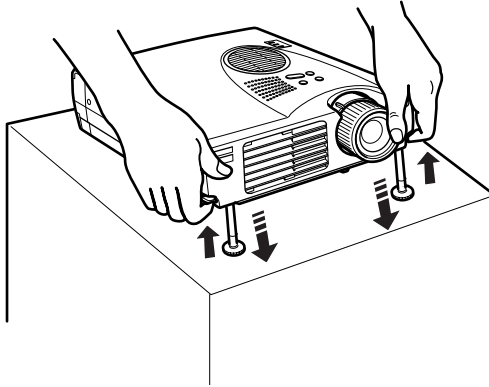

1. Stand behind the projector and support the front of it while you lift the foot adjust levers above the feet. This unlocks the feet so they can move up and down freely. Do not let the projector drop.

◆ **Caution:** Do not hold the projector by its lens. This can damage the lens.

2. While lifting the foot adjust levers, raise or lower the projector until the screen image is positioned correctly.
3. Release the lever to lock the feet in their new position.
4. To fine-tune the height of the projector, turn the feet clockwise to raise the height or anti-clockwise to lower it.

---

## Resize Button

The Resize button allows you to select the projection method for certain types of image input signals from a computer.

With images up to XGA size (1024 × 768) for the EMP-713/703 or SVGA size (800 x 600) for the EMP-503, you can choose from two projection methods. You can either display the image in the center of the projection area(Window display) or display the image full size(Resize display).

You can also choose from two projection methods with images greater than XGA size for the EMP-713/703 or SVGA size for the EMP-503 : either project a portion of the image or project the entire image in a compressed format. The projector automatically reduces the image size to the projector's maximum resolution. The Resize button cannot be used with images at XGA size for the EMP-713/703 or SVGA size for the EMP-503 resolution.

When the image source is Video, the resize button lets you choose an aspect ratio either resize display or 16:9.

---

# Controlling the Projector

You can use the operation panel on top of the projector or the remote control to perform the following actions:

- Turn the power on or off
- Auto set-up of the computer image
- Switch between input images (Computer, video-computer)
- Access the projector menus to adjust the image, audio, video, and display settings
- Resize the projected image
- Freeze the display
- Temporarily display a blank screen
- Adjust or mute audio/video output
- Use custom functions
- Move the mouse pointer



# Using the Remote Control

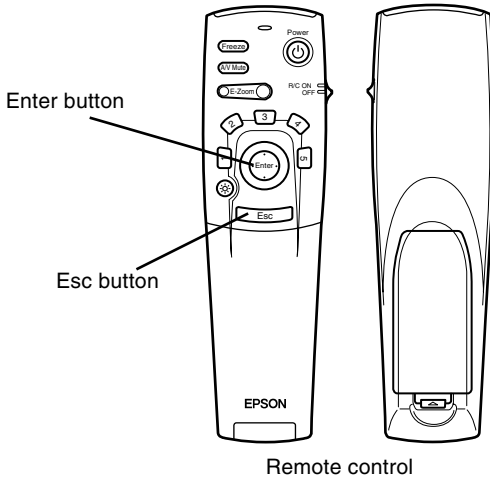

To use the remote control, point it towards the remote control receivers located at the front of the projector.

To be able to use the remote control as a cordless mouse, connect the mouse cable to the projector and your computer.

You can use the remote control up to 10 metres (30 feet) from the projector.

- ◆ **Note:** *The projector may not respond to remote control commands in these conditions: ambient light is too bright; a certain type of fluorescent light is present; a strong light source (such as direct sunlight) shines into the infrared receiver; or other equipment emitting infrared energy is present (such as a radiant room heater). Correct these conditions to use the remote control or control the projector from a computer.*

---

This table summarizes the functions on the remote control.

<b>Button</b>	<b>Function</b>
Freeze	Keeps the current computer or video image on the screen.
A/V Mute	Turns off the audio and video output of the projector. To turn on the audio and video output, press either the A/V mute button or Esc button again.
E-Zoom	Pressing the right side of the button enlarges the image, pressing the left side of the button reduces the image. To display a portion of the enlarged image which is outside of the display area, press the Enter button to scroll the image.
Power	Turns the projector on or off.
Effect buttons	Use to display special effects that have been assigned in the Effect menu.
Enter	Use the enter button to navigate the menus or use the remote as a mouse pointer when the projector is connected to the computer with the computer cable and the mouse cable. You can also select a menu option by pressing the center of this button (Enter). If you press the Enter when a menu or help is displayed, you access the next menu or screen. When the image source is a computer, the Enter button acts as the mouse left click.
Illumination button	Lights up all buttons on the remote control for 10 seconds.
Esc	Terminates the current function. If you press the Esc button when a menu or help is displayed, you go back to the previous screen or menu. When the image source is a computer, the Esc button acts as the mouse right click.
Menu	Displays or hides the menu.
Help	Displays the Help menu.

---

---

<b>Button</b>	<b>Function</b>
Comp	Switches to the computer image from Computer.
S-Video	Switches to the video image from S-Video.
Video	Switches to the image from Video.
Auto	Optimizes the computer image.
Resize	Switches between the Window display and Resizing display.
P in P	<p>Displays a subscreen on the main display. To display the subscreen, press the PinP button once. To hide the subscreen, press it again.</p> <p>To set the subscreen being displayed, press in the following order :</p> <p>[Menu] → [Setting] → [P in P].</p> <p>The default settings are as follows;</p> <p>Subscreen size:1/9 division</p> <p>Main screen input source:Computer</p> <p>Subscreen input source:Video</p> <p>To change the subscreen position, press the Enter button. The subscreen will move to the selected direction.</p>
Volume +/-	Adjusts the volume.

---



# Using the Operation Panel

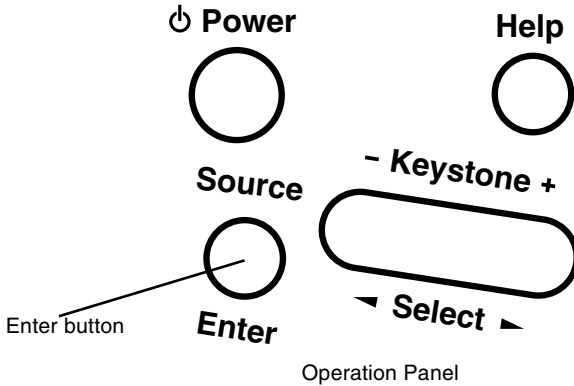

You can use the operation panel to control the projector instead of the remote control. However, you can program and access the custom features only using the remote control.

The following table summarizes the functions on the operation panel.

Button	Function
Power	Turns the projector on or off.
Help	Displays the Help menu.
Source	Switches the image source in order of computer → S-video → composite video. If there is no S-video input, the switch toggles between computer and composite video.
Enter	Selects a menu option when the Help menu is displayed.
Keystone +/-	Adjusts a trapezoid distorted image to normal.
Select	Scrolls up and down, or right and left when the Help menu is displayed.

---

# Projector Status Indicators

The power and lamp indicators at the top of the projector tell you its operating status.

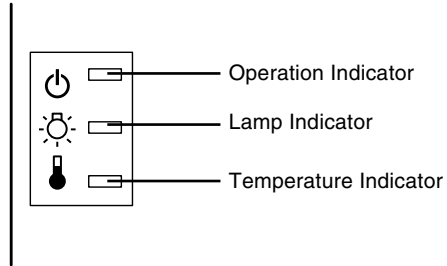

- ◆ **Caution:** A red indicator warns you if a serious problem occurs. See Chapter 5, “Troubleshooting,” for what to do if a warning light comes on.

## Operation Indicator

Displays machine condition.

Color	Status	Meaning
Orange	Lit	Sleep mode. (The projector is plugged in, but not projecting.)
Green	Flashing	The projector is warming up.
Green	Lit	Power and projection lamp are on.
Orange	Flashing	Projection lamp is off, and the projector is cooling down for one minute. Cooling time depends on the air temperature. During the cooling, any other operations cannot be executed.
Red	Lit	There is an internal projector problem .
-	Off	The projector is not on.

---

## Lamp Indicator

Displays lamp condition.

This indicator is off when the projector is in a normal condition.

Color	Status	Meaning
-	Off	Lamp is functioning normally.
Red	Lit	The lamp needs to be replaced.
Orange	Flashing	Projection lamp has reached the time to replace and will no longer project images. Replace the projection lamp with a new one.
Red	Flashing	Lamp error. First, remove the lamp and check to see if it is broken (be careful not injure yourself on broken glass if the lamp is broken). If the lamp is not broken reset it. Next, plug in the power plug and turn on the main unit's power. If the problem still persists or the lamp is broken, contact your dealer or nearest address provided at "International Warranty Conditions" in "Safety Instructions/World-Wide Warranty Terms" included in the package. (images cannot be projected unless the lamp is replaced.)

---

## Temperature Indicator

Displays the internal temperature condition.

This indicator is off when the projector is in a normal condition.

Color	Status	Meaning
-	Off	The projector is functioning normally.
Orange	Flashing	The projector is too hot.

---

<b>Color</b>	<b>Status</b>	<b>Meaning</b>
Red	Lit	<p>The projector has turned off automatically because of over heating. The lamp goes off automatically and projection becomes impossible. Wait for approximately 5 minutes with the projector in that state. After 5 minutes has passed, pull out the power plug once, then insert it again.</p> <p>If the projector overheats, check the following 2 points and make the necessary improvements.</p> <ul style="list-style-type: none"> <li>• Is the projector installed in a place with good ventilation? Make sure the air intake and exhaust vents are not covered, and that it is not placed up against the wall.</li> <li>• Has dust accumulated in the air filter? If the air filter is dirty, clean it.</li> </ul> <p>When the power plug is reinserted, the projector will recover to the normal state, so press the power button and turn on the power again. If the projector overheats again even when the above measures have been taken, and when an error is displayed in the indicator when the power is turned on again, discontinue use, Pull the power plug out of the receptacle then request repairs by the retail shop where you purchased it, or by the service office at the nearest address provided at “International Warranty Conditions” in “Safety Instructions/World-Wide Warranty Terms” included in the package.</p>
Red	Flashing	<p>There is a problem with the cooling fan or temperature sensor.</p> <p>Pull the power plug out of the receptacle then request repairs by the retail shop where you purchased it, or by the service office at the nearest address provided at “International Warranty Conditions” in “Safety Instructions/World-Wide Warranty Terms” included in the package.</p>







# 3

## Using the Projector Menus

The eight projector menus let you to control your projector.

- The Video menu controls the look and quality of the projected image, whether the image source is a computer or video.
- The Audio menu controls audio features, such as the volume level, tone setting.
- The Effect menu lets you define functions for the Effects buttons on the remote control.
- The Setting menu lets you select various projector options.
- The User's Logo menu lets you select special features such as background color or a custom logo.
- The Advanced menu enables you to set various projector options.
- The About menu provides information about H/V(Horizontal/Vertical) frequency, and lamp hours etc.
- The Reset All menu returns all settings to their factory defaults.

---

# Accessing the Main Menu

To display the Main menu, press the Menu button on the remote control. The Main menu appears:



Press the Menu button again to hide the menu.

---

# Changing a Menu Setting

To change a menu setting:

1. Press the Menu button on the remote control to display the Main menu.
2. Press the top or bottom of the Enter button to scroll through the menu choices.

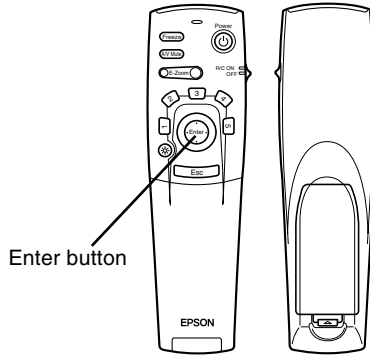

3. Press the Enter button to display a submenu.

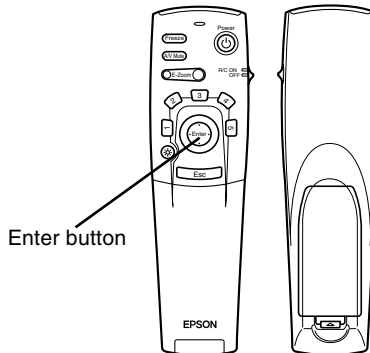

As you select a menu, a sub menu of options appears to the right.



- ◆ **Note:** *The options available in some submenus vary, depending on whether the current image source is the computer or a video source.*
- 4. Press the top or bottom of the Enter button to scroll through the menu choices.
- 5. Press the right or left sides of the Enter button to change a setting on one of the submenus.
- 6. When you are finished changing settings, press the Menu button again to hide the menu, or press the Esc to go back to the Main menu. Your changes are saved automatically.

---

# Menu Options

## Video Menu (Image source = Computer)

The Video menu lets you make adjustments to the projected image. The following options are available when the image source is Computer.

- ◆ **Note:** *The computer must be connected and operating, and the image source on the projector must be set to Computer for you to access these menu options.*

Menu item	Description
Position	Select this item by pressing the Enter button to enter the screen position adjustment mode. Then use the Enter button to move the screen position in the corresponding direction. When you finish making adjustment, press the Esc button to return to the Video submenu.
Tracking	Matches the projector's internal clock to various computer graphic signals. Adjust this setting to remove vertical lines from the image.
Sync.	Synchronizes with the tracking signal sent from the computer. Adjust this setting to correct fuzziness or screen flicker.
Brightness	Lightens or darkens the overall image. Increase brightness to lighten an image, or decrease it to darken the image.
Contrast	Adjusts the difference between light and dark areas. Increase the contrast to make light areas lighter and dark areas darker. Decrease it to minimize the difference between light and dark areas.

---

<b>Menu item</b>	<b>Description</b>
Color	Adjusts the color balance (Red:Green:Blue) of the input source. Select this item by pressing the Enter button. The projector will enter color adjustment mode. Use the Enter button to select a color. Next, use the Enter button to adjust the selected color. Increase the color setting for more intense color, or decrease the setting for less intense color.
Sharpness	Adjusts the screen sharpness. Increase the sharpness for a sharper image, or decrease it for a less sharp image.
Auto Setup	Set to On to have the computer automatically optimize the image for projection.
Gamma	Adjusts the projected imagery for natural coloration.
Reset	Returns all menu items to their initial factory defaults. Select this item and then press the Enter button to display the confirmation screen. Next, select Yes and then press the Enter button to reset the menu. If you change your mind, select No and then press the Enter button to clear the confirmation screen without changing any settings.

---

---

## Video Menu (Image source = Video)

The Video menu lets you make adjustments to the projected image. The following options are available when the image source is Video.

- ◆ **Note:** *The projector's image source must be set to Video, and the video source (such as a VCR or camcorder) must be connected and operating for you to access these menu options (for example, the projector must actually be projecting an image from a video tape, if you're using a VCR).*

Menu item	Description
Position	Select this item by pressing the Enter button to enter the screen position adjustment mode. Then use the Enter button to move the screen position in the corresponding direction. When you finish making adjustment, press the Esc button to return to the Video submenu.
Brightness	Lightens or darkens the overall image. Increase brightness to lighten an image, or decrease it to darken the image.
Contrast	Adjusts the difference between light and dark areas. Increase the contrast to make light areas lighter and dark areas darker. Decrease it to minimize the difference between light and dark areas.
Color	Adjusts color density. Increase the setting for darker and more opaque colors. Decrease it for lighter and less opaque colors.
Tint	Adjusts the red-green color balance of the screen. Increase tint to add more green, (NTSC only) or decrease it to add more red. This setting only works with NTSC video signals.
Sharpness	Adjusts the screen sharpness. Increase the sharpness to make screen images more sharp, or decrease it to make the images less sharp.
Gamma	Adjusts the projected imagery for natural coloration.

---

<b>Menu item</b>	<b>Description</b>
Mode	Specifies the image signal mode. User can select from Auto, NTSC, NTSC4.43, PAL, M-PAL, N-PAL, PAL 60, SECAM.
Reset	Returns all menu items to their initial factory defaults. Select this item and then press the Enter button to display the confirmation screen. Next, select Yes and then press the Enter button to reset the menu. If you change your mind, select No and then press the Enter button to clear the confirmation screen without changing any settings.

---

## Audio Menu

The Audio menu lets you make adjustments related to audio.

<b>Menu item</b>	<b>Description</b>
Volume	Adjusts the volume level for the speakers and audio-out terminal.
Tone	Adjusts the sound quality.
Reset	Returns all menu items to their initial factory defaults. Select this item and then press the Enter button to display the confirmation screen. Next, select Yes and then press the Enter button to reset the menu. If you change your mind, select No and then press the Enter button to clear the confirmation screen without changing any settings.

---



---

## Effect Menu

Use the Effect menu to modify what happens when you use the Effects buttons on the remote control and to change the cursor speed.

Menu item	Description
Cursor/Stamp	Selects the stamp icon you want to use as the cursor graphic and a zoom rate.
Box	Selects the box color and shape.
Marker	Selects the marker color and width.
Freehand	Selects the color and width.
Cursor Speed	Selects the cursor speed to Low, Middle, or High.
Reset	Returns all menu items to their initial factory defaults. Select this item and then press the Enter button to display the confirmation screen. Next, select Yes and then press the Enter button to reset the menu. If you change your mind, select No and then press the Enter button to clear the confirmation screen without changing any settings.

## Setting Menu

The Setting menu lets you adjust or set the various projector options.

Menu item	Description
Keystone	Adjusts the trapezoid distorted image to normal.
P-in-P	Selects the image source (composite or S-Video) for the subscreen.

---

<b>Menu item</b>	<b>Description</b>
No-Signal Msg	Specifies whether a black screen, a blue screen, or a user logo displays when the screen is blanked.
Prompt	Temporarily displays a message on the projector screen to identify which source (computer or video) is providing the image.
A/V Mute	Turns off/on the audio/video output of the projector, clears all special effects, and displays a black, blue, or user logo screen.
Power Mgmt Sys	You can select to turn off or keep the lamp power on when there is no input source.
Reset	Returns all menu items to their initial factory defaults. Select this item and then press the Enter button to display the confirmation screen. Next, select Yes and then press the Enter button to reset the menu. If you change your mind, select No and then press the Enter button to clear the confirmation screen without changing any settings.

---

## User's Logo Menu

The User's Logo menu lets you display a custom logo on the screen.

Creating a user logo requires two steps:

- Storing a user logo
- Assigning the logo to the A/V Mute button

---

## Storing a User Logo

Follow these steps to capture and store a logo.

1. Display the image(with the projector) you wish to use as a logo.
2. Press the Menu button to open the Menu window.
3. Select the User's Logo menu option by pressing the pointer button. Then press the Enter button to display the User's Logo Setting window.
4. The message, "Do you use the present image as a user logo?" appears on the screen. Choose Yes or No by pressing left or right of the Enter button. Then press Enter button.
5. When you choose "Yes" in the step 4, a selection box will appear over the image. To select the portion of the image you wish to use as the logo, use the Enter button. Once you have selected the desired area, press the Enter button.
6. The message "Do you use this image?" appears on the screen. Select Yes and press the Enter button. If you want to change the position, select No.
7. Next, the Zoom rate setting window appears on the screen. Select a rate using the arrow buttons, then press the Enter button.
8. The message "Do you save this user logo?" appears on the screen. Select Yes and press the Enter button. If you don't want to save the logo, select No.

◆ **Note:** *Saving the logo may take a moment. Do not use the projector or other sources (computer, video, speaker, etc.) while the logo is being saved.*

9. When the message "Saving the user logo is completed" appears on the screen, press the Menu or Enter button to display the Main Menu.

---

## Assigning the Logo to the A/V Mute Button

Follow these steps to assign the logo to the A/V Mute button:

1. Press the Menu button to open the Menu window.
2. Select the Setting menu and press the Enter button.
3. Select the Blank option (A/V Mute), then highlight User Logo.
4. Press the Menu button twice.

Now you can press the A/V Mute button on the remote control to display the user logo.

## Reset All Menu

Selecting the Reset All menu option resets the settings in all menus to their factory defaults. It does not change or delete any user logo you may have stored.

You will be prompted to confirm the reset action. Select Yes or No, then press the Enter button to reset all the settings.

---

# Advanced Menu

The Advanced menu enables you to set various projector options.

<b>Menu item</b>	<b>Description</b>
Language	Selects the menu language from Japanese, English, German, French, Italian, Spanish, Portuguese, Chinese and Korean.
Startup Screen	Displays the user logo during the warm-up after the projector is turned on.
Color Temp.	Adjusts the whiteness and blackness of the screen. Increasing the values emphasizes the whiteness and blackness. Decreasing the values weakens the whiteness and blackness.
Rear Proj.	Mirrors the projected image so it looks correct when you're projecting from behind onto a translucent screen. Selecting ON turns mirroring on, while OFF turns it off (for a normal image).
Ceiling	Flips the projected image so it looks correct when you're hanging the projector upside-down from the ceiling. Selecting ON turns this feature on, while OFF turns it off (for a normal image).
Reset	Returns all menu items to their initial factory defaults. Select this item and then press the Enter button to display the confirmation screen. Next, select Yes and then press the Enter button to reset the menu. If you change your mind, select No and then press the Enter button to clear the confirmation screen without changing any settings.

---

---

# About Menu

The About menu displays the following information about your projector.

Image source = Computer or Component Video

---

<b>Menu item</b>	<b>Description</b>
Lamp	Displays the number of hours the current lamp has been used. The lamp light turns red when the projector lamp needs to be replaced. When this happens, replace the projector lamp with a new one as soon as possible.
Frequency	Displays the horizontal and vertical frequency of the computer.
SYNC Polarity	Displays the sync polarity of the computer.
SYNC Mode	Displays the sync mode of the computer.
Resolution	Displays the output resolution of the computer video output.
Refresh Rate	Displays the refresh rate of the computer video output.

---

Image source = Video

---

<b>Menu item</b>	<b>Description</b>
Lamp	Displays the number of hours the current lamp has been used. The lamp light turns red when the projector lamp needs to be replaced. When this happens, replace the projector lamp with a new one as soon as possible.
Video Signal	Displays the input image signal mode.

---



# 4

## Maintenance

Your projector needs little maintenance. You should keep the lens clean because any dirt or smears appear on the screen. You also need to periodically clean the air filter. A clogged air filter can block ventilation needed to cool the projector and keep it from overheating.

The only parts you should replace are the lamp and air filter. If any other part needs replacing, contact your dealer or a qualified service person.

- ◆ **Warning:** *Before you clean any part of the projector, turn off the projector and unplug the power cord. Never open any cover on the projector, except the lamp and filter covers. Dangerous electrical voltages in the projector can injure you severely. Do not try to service this product yourself, except as specifically explained in this User's Guide. Refer all other servicing to qualified service personnel.*

---

## **Cleaning the Lens**

Clean the lens whenever you notice dirt or dust on the surface. Lightly wipe the lens surface with a soft, dry, lint-free cloth.

To remove dirt or smears on the lens, moisten a soft cloth with an alcohol-based cleaner and gently wipe the lens surface.

## **Cleaning the Projector Case**

To clean the projector case, first unplug the power cable. To remove dirt or dust, wipe the case with a soft, dry, lint-free cloth. To remove stubborn dirt or stains, moisten a soft cloth with water and a neutral detergent. Then wipe the case.

Do not use alcohol, benzene, thinners or other chemical detergents. These can cause the case to warp.



---

# Cleaning the Air Filter

Clean the air filter at the top of the projector after every 100 hours of use. If it is not cleaned periodically, it can become clogged with dust, preventing proper ventilation. This can cause overheating and damage the projector. To clean the air filter, follow these steps:

1. Turn off the projector and unplug the power cable.
2. Stand the projector with the lens at the top.

◆ **Note:** *Standing the projector with the lens at the top keeps dust from getting inside the projector housing.*

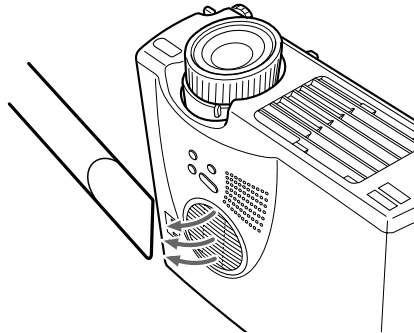

3. Use a small vacuum cleaner designed for computers and other office equipment to clean the filter.

If the dirt is difficult to remove or if the filter is torn, replace it. Contact your dealer for a spare air filter.

---

# Replacing the Lamp

Replace the lamp when:

- The projected image gets darker or starts to deteriorate.
- The projection lamp indicator is flashing orange .
- The message “LAMP REPLACE” appears on the screen when the projector lamp comes on.

◆ **Note:** *To keep the initial brightness and image quality, replace the lamp as soon as possible when the message appears on the screen. The replacement message is set to being displayed at about 900 hours of use. Contact your local EPSON dealer for a spare lamp. Request part number ELPLP14.*

◆ **Warning:** *Let the lamp cool before replacing it. Also, do not touch the glass portion of the lamp assembly. Touching the glass portion of the lamp will result in premature lamp failure.*

1. Turn off the power and allow the unit to cool down, then remove the power cord.  
The amount of time needed to cool down will depend on the ambient temperature.

- 
- Remove the lamp cover after the unit is cool. It will normally take about an hour to completely cool down. Loosen a lamp cover-mounting screw with the screwdriver provided with the spare lamp, then remove.

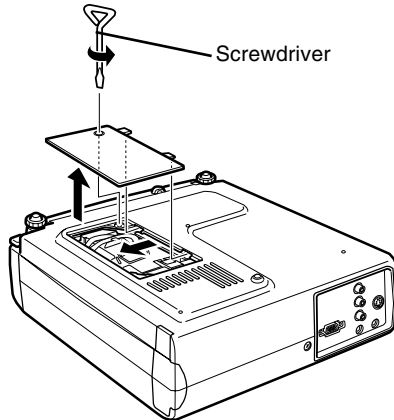

- Loosen two mounting screws for the lamp with the same screwdriver, and pull out the lamp using the handle.

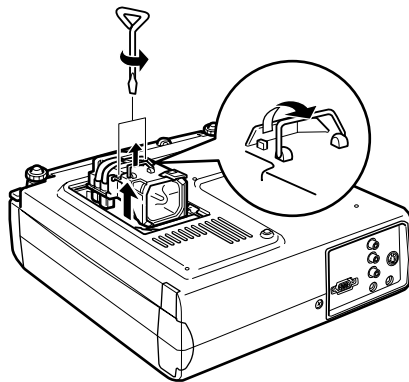

- Mount new lamp. Check that the lamp orientation is correct, and then press it into place securely. Tighten the mounting screws for the lamp with the screwdriver.
- Remount the lamp cover. Tighten the lamp cover screw with the screwdriver.





# 5

## Troubleshooting

This chapter describes the problems indicated by the warning lights and provides information on how to solve problems with the projector. It is divided into the following sections:

- Problems with the projector. See this section if the projector is not working and to find out what the warning lights are indicating.
- Problems with the screen image. See this section if you cannot project an image or if the screen image is poor.

If you have a problem, refer to the appropriate section and follow all suggestions that apply to your problem. If none of the suggested solutions solves the problem, call your dealer or nearest address provided at “International Warranty Conditions” in “Safety Instructions/World-Wide Warranty Terms” included in the package.

---

# Problems with the Projector

If you have problems with the projector, first turn it off and unplug it. Then plug the power cord back in and turn on the projector. If this does not solve the problem, check the warning lights at the top of the projector. These lights alert you to problems with projector operation.

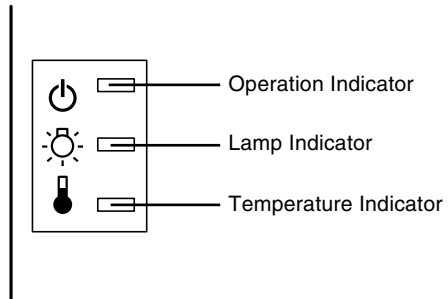

See the following pages for information on what to do when you see these warning lights or encounter other specific problems with the projector.

- ❑ **The operation indicator is flashing orange and you cannot turn on the projector.**

The lamp is cooling down. Wait until the light turns off and then turn on the projector.

- ❑ **The operation indicator does not come on.**

Turn off the projector, check that the power cable is connected securely both at the power outlet and the projector, and press the Power button again.

- ❑ **Projected images get darker or start to deteriorate, or the lamp indicator is red.**

Replace the projector lamp as described on page 60.

---

□ **The temperature indicator is red.**

The projector is overheating, which turns the lamp off automatically. Let the projector cool for a few minutes, then turn it back on. Make sure nothing is blocking the ventilation vents.

The air filter may be clogged. Clean it as described on page 59 in Chapter 4 and then let the projector cool for a while.

If the projector continues to overheat after you clean the air filter, the problem may be caused by damage to the cooling fan or internal circuits. Contact your dealer or nearest address provided at “International Warranty Conditions” in “Safety Instructions/World-Wide Warranty Terms” included in the package.

- ◆ **Warning:** *Do not attempt to service this product yourself except as specifically explained in this User’s Guide.*

---

# Problems with the Image or Sound

❑ **An image does not appear on the screen.**

Check that the power light is on and the lens cover is off. Also make sure the cables are installed correctly, as described in Chapter 1.

The correct image source may not be selected. Press the Source button on the remote control or the Source button on the appropriate input operation panel to choose another image source.

❑ **Only part of the computer image is displayed.**

If the computer's output resolution setting is higher than 1024 × 768 (EMP-713/703) and 800 × 600 (EMP-503), the projector resizes the image. If the computer output is not compatible with this resizing, choose a different display setting on the computer. For supported display settings, see "Supported Monitor Displays" on page 71, 72.

You also may need to modify existing presentation files if you created them for a different resolution. See your software manual for specific information.

❑ **The message NO SIGNAL is displayed.**

An image source not connected to the projector is selected, the signal is not being output from the computer, or the signal is not reaching the projector. Make sure the connectors are securely attached to both the projector and the image source. Then check that the image source is selected correctly. When NO SIGNAL is displayed, you cannot access the Video (computer/video) menu.



---

**❑ A blank screen is displayed.**

The computer signal cannot be interpreted by the projector. Verify the display format (see page 71, 72). When you see a blank screen, you cannot access the projector menus.

**❑ The image or parts of the image are blurred or not in focus.**

Adjust the Brightness and Contrast settings on the Video menu. If you're viewing a computer image, also try adjusting the Tracking and Sync buttons on the projector's operation panel.

There may be dirt or smears on the lens. Clean the lens as described in Chapter 4, "Maintenance."

**❑ The colors of the image are not right.**

The color balance may be incorrect. If you're displaying a computer image, adjust the red, green, and blue settings in the Video menu. If you're displaying video, adjust the Color and Tint (NTSC only) settings on the Video menu.

**❑ There is no sound.**

First check that the volume setting is not turned all the way down and that the RCA audio cable is securely attached to both the projector and the audio source. Also, make sure that the Mute button is off.

The wrong source is selected. Press either the Computer or Video button on the remote control or Source button on the operation panel to select the proper source.





6



# Technical Specifications

---

## General

---

Type of display	Poly-silicon TFT
Size of liquid crystal panels	0.9 inches (22.9 mm)
Resolution	EMP-713/703: 1024 (horizontal) x 768 (vertical) pixels EMP-503: 800(horizontal) x 600(vertical) pixels
Projection distance	26-300 inch (1.1-13.8 meters)
Remote control range	32.8 feet (10 meters)
Internal speaker system	1W Monaural
Optical aspect ratio	4 : 3 (horizontal : vertical)
Zoom ratio	1:1.2

---

---

## Projector Lamp

---

Type	UHE Lamp (Ultra High Efficiency Lamp)
Power	150 W
Part number	ELPLP14

---



---

**Mechanical**

---

Height	7.4 inches (87 mm) Maximum dimension
Width	19.8 inches (267 mm) Maximum dimension
Depth	12 inches (213 mm) Maximum dimension
Weight	5.8 lb (2.6 kg)

---

---

**Electrical**

---

Voltage	100 - 240 V <sub>AC</sub>
Rated frequency	50/60 Hz
Power supply	100 - 240 V <sub>AC</sub> 2.6 - 1.3A

---

---

**Environmental**

---

Temperature	Operation: 41 - 95° F (5 - 35° C), non-condensing  Storage: 14 - 140° F (-10 - 60° C), non-condensing
Humidity	Operation: 20 - 80% RH, non-condensing  Storage: 10 - 90% RH, non-condensing

---

# Supported Monitor Displays

The projector displays images at a resolution of 1024 x 768 (EMP-713/703) and 800 x 600 (EMP-503) pixels.

To display a higher resolution image, the projector compresses it to 1024 x 768 (EMP-713/703) and 800 x 600 (EMP-503). The following table lists the display formats supported by the projector:

A: Resize B: Native

Mode	ACTIVE		FREQUENCY			MODEL	
	H	V	H (KHz)	V (Hz)	Pixel (MHz)	EMP-713/703	EMP-503
VGAEGA	640	350	31.46	70	25.175	A/B	A/B
VGA60	640	480	31.469	59.94	25.175	A/B	A/B
VGA72	640	480	37.861	72.809	31.5	A/B	A/B
VGA75	640	480	37.5	75	31.5	A/B	A/B
VGA85	640	480	43.269	85.008	36	A/B	A/B
VGA Text	720	350	31.469	70.087	28.322	A/B	A/B
VGA Text	720	400	31.469	70.087	28.322	A/B	A/B
SVGA56	800	600	35.156	56.25	36	A/B	B
SVGA60	800	600	37.879	60.317	40	A/B	B
SVGA72	800	600	48.077	72.188	50	A/B	B
SVGA75	800	600	46.875	75	49.5	A/B	B
SVGA85	800	600	53.674	85.061	56.25	A/B	B
XGA43i	1024	768	35.522	86.958	44.9	B	A
XGA60	1024	768	48.363	60.004	65	B	A
XGA70	1024	768	56.476	70.069	75	B	A
XGA75	1024	768	60.023	75.029	78.75	B	A
XGA85	1024	768	68.677	84.997	94.5	B	A
SXGA1_70	1152	864	63.851	70.012	94.5	A	A
SXGA1_75	1152	864	67.5	75	108	A	A
SXGA1_85	1152	864	77.094	84.999	121.5	A	A
SXGA2-60	1280	960	60	60	108	A	A
SXGA2-75	1280	960	75	75	126	A	A



A: Resize B: Native

Mode	ACTIVE		FREQUENCY			MODEL	
	H	V	H (KHz)	V (Hz)	Pixel (MHz)	EMP-713/703	EMP-503
SXGA2-85	1280	960	85.938	85.002	148.5	A	A
SXGA3_43i	1280	1024	46.433	86.871	78.75	A	A
SXGA3_60	1280	1024	63.981	60.02	108	A	A
SXGA3_75	1280	1024	79.976	75.025	135	A	A
SXGA3_85	1280	1024	91.146	85.024	157.5	A	A
UXGA60*	1600	1200	75	60	162	A	-
MAC II 13	640	480	35	66.67	30.24	A/B	A/B
MAC16	832	624	49.107	75.087	55	A/B	A/B
MAC19-60	1024	768	48.193	59.28	64	B	B
MAC19	1024	768	60.241	74.93	80	B	B
MAC21	1152	870	68.682	75.062	100	A	A
NTSC	640	480	15.734	60	-	A	A
PAL	720	540	15.625	50	-	A	A
SECAM	720	540	15.625	50	-	A	A

◆ **Note:** *The frequencies of some computers may not allow the image to be display correctly.*

\* The EMP-503 does not support UXGA.

---

# Computer In connector pin assignments

The Computer In connectors are female video RGB, 15-pin micro-D-style connector. The pin assignments are:

Input pin	Signal
1	Red analogue input
2	Green analogue input
3	Blue analogue input
4	GND
5	GND
6	Red GND
7	Green GND
8	Blue GND
9	Reserved
10	Sync GND
11	GND
12	SDA
13	Horizontal sync/composite sync input
14	Vertical sync input
15	SCL







# Glossary

**Brightness.** The balance of light and dark shades in an image.

**Composite video.** A type of video signal that encodes colours, luminance and synchronization information so it can be carried in one signal.

**Contrast.** A measure of the luminance differences between the highlights and shadows of an image. In a high-contrast image, light areas are very bright and dark areas are very dark.

**NTSC.** A 525-line video broadcast format developed by the National Television Standards Committee. NTSC is widely used in North America, Mexico and Japan.

**PAL (Phase Alternation by Line).** A 625-line video broadcast format used in Western Europe, India, China, Australia, New Zealand and parts of Africa.

**Resolution.** A measure of the amount of detail contained in an image. Resolution can be measured in dots per inch or in pixels. Image sharpness and clarity improve as resolution increases.

**RGB.** Red Green Blue

**S-Video.** A type of video signal which transmits luminance and colour separately.

**SECAM (Système Electronique pour Couleur Avec Mémoire).** A 625-line TV system used in France, Eastern Europe, Russia and parts of Africa.

---

**Serial.** A type of communication interface that transmits data over a single wire.



# Index

## A

Audio cable 9  
Audio In jack 9  
Audio Menu 50  
Audio Out jack 25

## B

Brightness 75

## C

Cleaning the Air Filter 59  
Color 49  
Contrast 75  
cooling 64

## D

DAR viii

## E

Effect Menu 51  
External Speaker 1, 25

## F

Format 71

## G

Glossary 75

## I

Image 66  
Installation x, 1

## M

Mac mouse cable 15  
Macintosh desktop adapter 13, 17  
Maintenance x, 57  
Mouse/Com port 8, 11

## N

NTSC 75

## O

operation indicator 28  
operation panel 28  
Optional Accessories ix

## P

PA System 1, 25  
PAL 75



---

pin assignments 73  
Power cord 2  
Projector ix  
PS/2 mouse cable 2, 8

## **R**

RCA audio cable 23  
RCA video cable 23  
Resolution 66, 75  
RGB 75

## **S**

SECAM 75  
Serial 76  
Setting Menu 51  
Sound 66  
stereo audio cable 25  
S-Video 75  
S-Video cable 24  
S-Video connector 24

## **T**

Technical Specifications x, 69  
Tone 50  
Troubleshooting x, 63

## **U**

USB mouse cable 2  
User's Logo Menu 52

## **V**

Video Source 22

video-out cable 17  
Volume 50

## **W**

wireless mouse 1  
World Wide Web xi

# DECLARATION of CONFORMITY

according to ISO/IEC Guide 22 and EN 45014

Manufacturer : SEIKO EPSON CORPORATION  
Address : 3-5, Owa 3-chome, Suwa-shi,  
Nagano-ken 392-8502 Japan  
Representative : EPSON EUROPE B. V.  
Address : Entrada 701, 1096 EJ AMSTERDAM,  
The Netherlands

Declares that the Product

Kind of Equipment : LCD Projector  
Model : ELP-713/703/503/EMP-713/703/503

Conforms to the following Directives and Norm(s)

**Directive 89/336/EEC**

: EN 55022  
: EN 55024  
: EN61000-3-2  
: EN61000-3-3

**Directive 73/23/EEC**

: EN 60950

# DECLARATION of CONFORMITY

According to 47CFR, Part 2 and 15 for  
**Class B Personal Computers and Peripherals; and/or  
CPU Boards and Power Supplies used with Class B  
Personal Computers**

We : EPSON AMERICA, INC.  
Located at : MS: 3-13  
3840 Kilroy Airport Way  
Long Beach, CA 90806-2469  
Telephone : (562) 290- 5254

Declare under sole responsibility that the product identified herein, complies with 47CFR Part 2 and 15 of the FCC rules as a Class B digital device. Each product marketed, is identical to the representative unit tested and found to be compliant with the standards. Records maintained continue to reflect the equipment being produced can be expected to be within the variation accepted, due to quantity production and testing on a statistical basis as required by 47CFR 2.909. Operation is subject to the following two conditions : (1) this device may not cause harmful interference, and (2) this device must accept any interference received, including interference that may cause undesired operation.

**Trade Name** : EPSON  
**Type of Product** : LCD Projector  
**Model** : EMP-713/703/503/ ELP-713/703/503

---

# **FCC Compliance Statement**

## **For United States Users**

This equipment has been tested and found to comply with the limits for a Class B digital device, pursuant to Part 15 of the FCC Rules. These limits are designed to provide reasonable protection against harmful interference in a residential installation. This equipment generates, uses, and can radiate radio frequency energy and, if not installed and used in accordance with the instructions, may cause harmful interference to radio or television reception. However, there is no guarantee that interference will not occur in a particular installation. If this equipment does cause interference to radio and television reception, which can be determined by turning the equipment off and on, the user is encouraged to try to correct the interference by one or more of the following measures.

- Reorient or relocate the receiving antenna.
- Increase the separation between the equipment and receiver.
- Connect the equipment into an outlet on a circuit different from that to which the receiver is connected.
- Consult the dealer or an experienced radio/TV technician for help.

## **WARNING**

The connection of a non-shielded equipment interface cable to this equipment will invalidate the FCC Certification or Declaration of this device and may cause interference levels which exceed the limits established by the FCC for this equipment. It is the responsibility of the user to obtain and use a shielded equipment interface cable with this device. If this equipment has more than one interface connector, do not leave cables connected to unused interfaces. Changes or modifications not expressly approved by the manufacturer could void the user's authority to operate the equipment.

## **For Canadian Users**

This digital apparatus does not exceed the Class B limits for radio noise emissions from digital apparatus as set out in the radio interference regulations of the Canadian Department of Communications.

Le présent appareil numérique n'émet pas de bruits radioélectriques dépassant les limites applicables aux appareils numériques de Classe B prescrites dans le règlement sur le brouillage radioélectrique édicté par le Ministère des Communications du Canada.









All rights reserved. No part of this publication may be reproduced, stored in a retrieval system, or transmitted in any form or by any means, electronic, mechanical, photocopying, recording, or otherwise, without the prior written permission of SEIKO EPSON CORPORATION. No patent liability is assumed with respect to the use of the information contained herein. Neither is any liability assumed for damages resulting from the use of the information contained herein.

Neither SEIKO EPSON CORPORATION nor its affiliates shall be liable to the purchaser of this product or third parties for damages, losses, costs, or expenses incurred by purchaser or third parties as a result of: accident, misuse, or abuse of this product or unauthorized modifications, repairs, or alterations to this product, or (excluding the U.S.) failure to strictly comply with SEIKO EPSON CORPORATION's operating and maintenance instructions.

SEIKO EPSON CORPORATION shall not be liable against any damages or problems arising from the use of any options or any consumable products other than those designated as Original EPSON Products or EPSON Approved Products by SEIKO EPSON CORPORATION.

EPSON is a registered trademark and PowerLite is a trademark of SEIKO EPSON CORPORATION.

**General Notice:** The following trademarks and registered trademarks are the property of their respective owners and are used in this publication for identification purposes only.

- EPSON/Seiko Epson Corp.
- Macintosh, PowerBook/Apple Computer Corp.
- IBM/International Business Machines, Inc.
- Windows/Microsoft Corp.

Other product names used herein are also for identification purposes only and may be trademarks of their respective owners. EPSON disclaims any and all rights in those marks.



# EPSON®

E

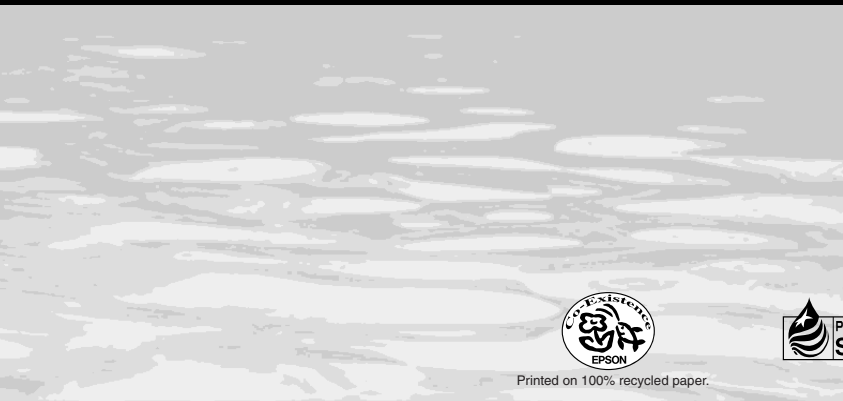

Printed on 100% recycled paper.



PRINTED WITH  
**SOY INK™**

Printed in Japan  
402120701  
(90018693)  
01.12-7A(C01)